

Fluidal Catálogo Inoxidable 2024001

CONEXIONES PARA FLEXIBLES

Crimp fittings for hoses
Embouts à sertir pour flexibles
Raccordi a pressare per tubi flessibili

1

TUBO RÍGIDO TRΔLE® / RACORES DIN 2353 / RACORES JIC 37°

TRΔLE® Rigid Pipe/ Pipe fittings DIN 2353/ Flare fittings JIC 37°
Tube rigide TRΔLE®/ Raccordi DIN 2353/ Adapteurs JIC 37°
Tubo rigido TRΔLE®/ Raccordi DIN 2353/ Raccordi JIC 37°

2

TUBO RÍGIDO TRΔLE® SCH / RACORES SCH / BRIDAS SAE / ABRAZADERAS

SCH TRΔLE® Rigid pipe/ SCH fittings / SAE Flanges / Clamps
Tube rigide TRΔLE® SCH / Embouts SCH / Brides SAE/ Colliers
Tubo rigido TRΔLE® SCH / Raccordi SCH / Flange SAE/ Collari fissatubo

3

ADAPTADORES

Adaptors
Adapteurs
Adattatori

4

RACORES SOLDABLES

Welding fittings
Raccordi à souder
Raccordi a saldare

5

RACORES INDUSTRIALES

Industrial fittings
Raccordi industriali
Raccordi industriali

6

ACCESORIOS

Accessories
Accessoires
Accessori

7

COMPONENTES HIDRÁULICOS AISI 316

Hydraulic Components AISI 316
Composants Hydrauliques AISI 316
Componenti Idraulici AISI 316

8

METROLOGÍA

Flow measuring
Test du circuit hydraulique
Test per circuiti idraulici

9

RACOR DOBLE ANILLO TRΔLE® LOK

Twin Ferrule Fittings TRΔLE® Lok
Raccord double bague TRΔLE® Lok
Raccordi per doppio anello TRΔLE® Lok

10

Conexiones Standard 22

Standard series
Embouts série standard
Serie Standard

Conexiones Serie BW+ R13/R15 No Pelar 42

Fittings BW+ Series R13/R15 No Skive
Embouts R13/R15 Série BW+ Sans dénuder
Raccordi R13/R15 Serie BW+ senza spellatura

Conexiones una sola pieza PTFE Liso / R14 75

One piece fittings for Smooth PTFE/ R14
Embouts pré-sertis pour PTFE lisse/ R14
Raccordi compatti per PTFE liscio/ R14

Conexiones Interlock 46

Interlock series
Embouts Interlock
Serie Interlock

Conexiones una sola pieza PTFE Corrugado 80

One piece fittings for convoluted PTFE
Embouts pré-sertis pour PTFE convoluté
Raccordi compatti per PTFE corrugato

Casquillos para conexiones una sola pieza 51

Ferrules for one piece fittings
Jupes pour embouts pré-sertis
Boccole per raccordi compatti

Conexiones Reusables 85

Reusable series
Embouts série récupérable
Serie Recuperabile

Conexiones una sola pieza Serie 43 R1AT/R2AT/1SN/2SN/R16/2SC/R17 52

One piece fittings 43 Series
R1AT/R2AT/1SN/2SN/R16/2SC/R17
Embouts pré-sertis
R1AT/R2AT/1SN/2SN/R16/2SC/R17 Série 43
Raccordi compatti R1AT/R2AT/1SN/2SN/R16/2SC/
R17 Serie 43

Conexiones Push-On 88

Push-On Fittings
Embouts Push-On
Raccordi Serie Push-On

Conexiones Alta Presión (700 bar) 89

High pressure 700 bar fittings
Embouts haute pression 700 bar
Raccordi Altissima pressione (700 bar)

Conexiones una sola pieza Serie BWS 3SP/4SP/R12/4SH No Pelar 60

One piece fittings BWS Series
3SP/4SP/R12/4SH No Skive
Embouts pré-sertis Série BWS
3SP/4SP/R12/4SH Sans dénuder
Raccordi Compatti Serie BWS 3SP/4SP/R12/4SH
senza spellatura

Conexiones una pieza Serie BW+ R13/R15 No Pelar 67

One piece fittings BW+ Series R13/R15 No Skive
Embouts R13/R15 Série BW+ Sans dénuder
Raccordi R13/R15 Serie BW+ senza spellatura

Conexiones una sola pieza R7/ R8/ Elastómero malla metálica 70

One piece fittings R7/R8 & Elastomer Braid of steel wire
Embouts pré-sertis R7/R8 et Elastomère tresse métallique
Raccordi compatti serie R7/R8 e elastomero treccia metallica



01

CONEXIONES PARA FLEXIBLES

Crimping fittings for hoses

Embouts à sertir pour flexibles

Raccordi a pressare per tubi flessibili



STANDARD SERIES

Serie Standard

TrAde®

TrAde® GOLD

GREENLINE



SAE 100 R6	EN 854 2TE	EN 854 3TE	SAE 100 R17	EN 857 2SC SUPERSERVICE 2SC 155°	EN 853 1SN SAE 100 R1AT 1SNK	EN 853 2SN SAE 100 R2AT 2SNK	EXCEED EN 857 2SCK	EN 857 2SC SUPERSERVICE 2SC 155°
81014		ZPF22120...	ZSC2112...	ZSC2112/ZPF22120		ZPF22120...		

EN 853 2ST SAE100 R2A	EN 856 4SP SAE 100 R9R	EN 856 R12 SAE 100	3SP	EN 856 4SP SAE 100 R9R	EN 856 4SH	EN856 R12 SAE 100	EN 856 R13 SAE 100	SAE 100 R15
ZPF12240...							3/4"-1"	

**NO PELAR
NO SKIVE**

SAE 100 R7 EN 855	SAE 100 R8 EN 855	Metallic 1 braid	Metallic 2 braid	Ecology 200	Ecology 250
81014...		81014...	ZPF1224	Z2120...	

Smooth PTFE R14 1 braid	Convoluted PTFE Standard	PTFLEX	Smooth PTFE R14 1 braid	Smooth PTFE 2 braid	Standard Convoluted PTFE	Fiberglass Convoluted PTFE	Antistatic Convoluted PTFE
88040...	88041...	81041...	81040...	81045...		81041...	



SERIE BW+ NO PELAR

BW+ Series no skive



EN 856
R13
SAE 100

SAE 100
R15



SERIE INTERLOCK

Interlock series



EN 856
4SH

EN 856
R13
SAE 100

SAE 100
R15



SERIE COMPACTA

One Piece Series
Série Pré-sertis
Serie Compatti

■ Conexiones compactas 1SC / 1SN / 2SC / R6 / 2TE

One piece fittings 1SC / 1SN / 2SC / R6 / 2TE
Embouts pré-sertis 1SC / 1SN / 2SC / R6 / 2TE
Raccordi compatti 1SC / 1SN / 2SC / R6 / 2TE



EN 857 1SC	EN 853 1 SN SAE 100 R1AT	EN 857 2SC	EN 854 SAE 100 R6	EN 854 2TE
---------------	-----------------------------------	---------------	-------------------------	---------------

■ Conexiones compactas Serie 43 R1AT / R2AT / 1SN / 2SN / R16 / 2SC / 3TE/R17

One piece fittings 43 Series R1AT / R2AT / 1SN / 2SN / R16 / 2SC / 3TE/R17
Embouts pré-sertis R1AT / R2AT / 1SN / 2SN / R16 / 2SC Série 43 / 2TE/ R17
Raccordi compatti R1AT / R2AT / 1SN / 2SN / R16 / 2SC Serie 43 / 3TE / R17

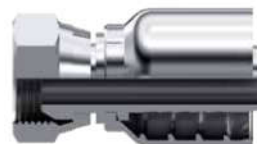

EN 853 1SN SAE 100R1AT	EN 853 2 SN SAE 100 R2AT	EN 857 2SC SAE 100 R16	SUPERSERVICE 155° 2SC	3TE
------------------------------	-----------------------------------	---------------------------------	-----------------------------	-----

■ Conexiones compactas Serie BWS NO PELAR 3SP / 4SP / 4SH / R12

One piece fittings Standar Series NON SKIVE 3SP / 4SP / 4SH / R12
Embouts pré-sertis SANS DÉNUDÉ 3SP / 4SP / 4SH / R12
Raccordi compatti SENZA PELATURA 3SP / 4SP / 4SH / R12



NO PELAR
NO SKIVE

3SP	EN 856 4SP SAE 100 R9R	EN 856 4SH	EN856 R12 SAE 100	EN 856 R13 SAE 100	SAE 100 R15
3/4"-1"					

■ Conexiones compactas Serie BW+ NO PELAR R13 / R15

One piece fittings BW+ Series NON SKIVE R13 / R15
Embouts pré-sertis SANS DÉNUDÉ R13 / R15
Raccordi compatti BW+ SENZA PELATURA R13 / R15



NO PELAR
NO SKIVE

EN 856 SAE 100 R13	SAE 100 R15
--------------------------	----------------

■ Conexiones compactas R7 / R8 y elastómero malla metálica

Piece fittings R7 / R8 & braid of steel wire
Embouts pré-sertis R7 / R8 et tresse métallique
Raccordi compatti serie R7 / R8 e elastomero treccia metallica



SAE 100 R7	SAE 100 R8	Metallic braid elastomer
---------------	---------------	--------------------------------

■ Conexiones compactas PTFE liso R14

One piece fittings for smooth PTFE R14
Embouts pré-sertis pour PTFE lisse R14
Raccordi compatti serie PTFE liscio R14



Smooth PTFE 1 braid

■ Conexiones compactas PTFE corrugado

One piece fittings for convoluted PTFE
Embouts pré-sertis pour PTFE convolute
Raccordi compatti serie PTFE corrugato



Convoluted
PTFE

Conexiones Standard

Standard series
Emboutis série standard
Serie Standard

Casquillos para prensar ▪ Crimping ferrules ▪ Jupes à sertir ▪ Boccole a pressare

22



PIPE
FITTINGS

PIPE
FITTINGS II

Conexiones BSP ▪ BSP Fittings ▪ Embouts BSP ▪ Raccordi BSP

25



ADAPTORS

Conexiones NPT-NPSM ▪ NPT-NPSM Fittings ▪ Embouts NPT-NPSM ▪ Raccordi NPT-NPSM

29



WELDING
FITTINGS

Conexiones JIC 37° ▪ JIC 37° Fittings ▪ Embouts JIC 37° ▪ Raccordi JIC 37°

30



INDUSTRIAL
FITTINGS

Conexiones Métricas DIN 2353 ▪ Metric fittings ▪ Embouts Métriques ▪ Raccordi Metrici

32



ACCESSORIES

Espigas lisas ▪ Standpipes ▪ Embouts lisses ▪ Estremità tubolari

36



CONTROL
COMPONENTS

Conexiones Varias ▪ Other Fittings ▪ Autres ▪ Raccordi vari

37



FLOW
MEASURING

Terminales hidrolavadoras ▪ Hydrowashing machine couplings ▪ Embouts pour hydronettoyage ▪ Raccordi per idropulitrici

37



TRALE LOK

Conexiones Standard

Standard series
Embouts série standard
Serie Standard

Orientables ▪ Banjos ▪ Embouts Banjo ▪ Raccordi ad occhio | 38



84111 Z1090 84116 Z1092

Bridas SAE ▪ SAE Flanges/Code 61 & 62 ▪ Brides SAE ▪ Flange SAE | 39



84182 84183 84184 84282 84283 84284

Bridas para flexibles ▪ SAE Flanges for hoses ▪ Brides SAE pour flexibles ▪ Flange per tubi flessibili | 40



ZBBP ZBBE ZTB ZBCE JBR ORING

Conexiones ORFS ▪ ORFS Fittings ▪ Embouts ORFS ▪ Raccordi ORFS | 41



84901 84912 84907 84908

Conexiones O´Ring Boss ▪ O´Ring Boss Fittings ▪ Embouts O´Ring Boss ▪ Raccordi O´Ring Boss | 41



84712

Conexiones Serie BW+ R13/R15 No Pelar

Fittings BW+ Series R13/R15 No Skive
Embouts R13/R15 Série BW+ Sans denuder
Raccordi R13/R15 Serie BW+ senza spellatura

Casquillos para conexiones serie BW/ BW+ ▪ Ferrules for fittings BW/ BW+ series ▪ Jupes pour embouts série BW/ BW+ ▪ Boccole a pressare per raccordi serie BW/ BW+

42



ZAC69010

PIPE
FITTINGS

Conexiones BSP ▪ BSP fittings ▪ Embouts BSP ▪ Raccordi BSP

42



Z66410

Z66117

Z66118

Z66112

Z66510

Z66517

Z66518

PIPE
FITTINGS II

Conexiones NPT/NPSM ▪ NPT/NPSM fittings ▪ Embouts NPT/NPSM ▪ Raccordi NPT/NPSM

43



Z66461

Z66161

ADAPTORS

Conexiones JIC 37º ▪ JIC 37º fittings ▪ Embouts JIC ▪ Raccordi JIC 37º

43



Z66242

Z66138

Z66139

Z66141

WELDING
FITTINGS

Conexiones ORFS ▪ ORFS fittings ▪ Embouts ORFS ▪ Raccordi ORFS

44



Z66901

Z66907

Z66908

Z66912

INDUSTRIAL
FITTINGS

Conexiones Métricas DIN 2353 ▪ Metric fittings ▪ Embouts Métriques ▪ Raccordi Metrici

44



Z66204

Z66205

Z66206

Z66203

ACCESSORIES

Bridas SAE ▪ SAE Flanges/ Code 61 & 62 ▪ Brides SAE ▪ Flange SAE

45



Z66282

Z66283

Z66284

CONTROL
COMPONENTS

FLOW
MEASURING

TRALE LOK

Conexiones Interlock

Interlock series
Embouts Interlock
Serie Interlock

Casquillos Interlock ▪ Interlock Crimping ferrules ▪ Jupes à sertir Interlock ▪ Boccole a pressare

46



Z61010

Z61010

Conexiones BSP y NPT ▪ Interlock BSP & NPT fittings ▪ Embouts à sertir Interlock BSP et NPT ▪ Raccordi BSP, NPT

46



Z64107

Z64108

Z64112

Z64161

Z64500

Z64507

Z64508

Conexiones JIC 37º ▪ Interlock JIC 37º fittings ▪ Embouts à sertir Interlock JIC ▪ Raccordi JIC 37º

48



Z64242

Z64142

Z64140

Z64138

Z64139

Conexiones Métricas DIN 2353 ▪ Interlock Metric fittings ▪ Embouts Métrique Interlock ▪ Raccordi Metrici

49



Z64204

Z64205

Z64206

Z64203

Conexiones ORFS ▪ Interlock ORFS fittings ▪ Embouts à sertir Interlock ORFS ▪ Raccordi ORFS

49



Z64901

Z64912

Z64907

Z64908

Bridas SAE ▪ Interlock SAE Flanges/ Code 61 & 62 ▪ Brides SAE Interlock ▪ Flange SAE

50



Z64182

Z64183

Z64184

Z64282

Z64283

Z64284

Casquillos para conexiones una sola pieza

Ferrules for one piece fittings
 Jupes pour embouts pré-sertis
 Boccole per raccordi compatti

Casquillos para Conexiones una sola pieza ▪ Ferrules for one piece fittings ▪ Jupes pour embouts pré-sertis ▪ Boccole per raccordi compatti

51



ZPFC2212

ZPF2224

88012

88040

88041

ZSCC2112

ZAC69010

Conexiones una sola pieza Serie 43 R1AT/R2AT/1SN/2SN/R16/2SC/R17

One piece fittings 43 Series R1AT/R2AT/1SN/2SN/R16/2SC/R17
 Embouts pré-sertis R1AT/R2AT/1SN/2SN/R16/2SC/R17 Série 43
 Raccordi compatti R1AT/R2AT/1SN/2SN/R16/2SC/R17 Serie 43

Conexiones una sola pieza JIC 37º ▪ One piece JIC 37º fittings ▪ Embouts pré-sertis JIC 37º ▪ Raccordi compatti JIC 37º | 52



88242 88142 88140 88138 88139

Conexiones una sola pieza ORFS ▪ One piece ORFS fittings ▪ Embouts pré-sertis ORFS ▪ Raccordi compatti ORFS | 54



88900 88907 88912 88908

Conexiones una sola pieza NPT-NPSM ▪ One piece NPT-NPSM fittings ▪ Embouts pré-sertis NPT-NPSM ▪ Raccordi compatti NPT-NPSM | 55



88361 88261 88262 88263 88161 88165

Conexiones una sola pieza Bidas SAE ▪ One piece SAE Flanges fittings ▪ Embouts pré-sertis Brides SAE ▪ Raccordi compatti Flange SAE | 56



88182 88183 88184 88282 88283 88284

Conexiones una sola pieza Métricas ▪ One piece Metric fittings ▪ Embouts pré-sertis Métriques ▪ Raccordi compatti Metrici | 57



88804 88203 88305 88306

Conexiones una sola pieza BSP ▪ One piece BSP fittings ▪ Embouts pré-sertis BSP ▪ Raccordi compatti BSP | 59



88400 88100 88200 88107 88108 88112

Conexiones una sola pieza Serie BWS 3SP/4SP/R12/4SH No Pelar

One piece fittings BWS Series 3SP/4SP/R12/4SH No Skive
 Embouts pré-sertis Série BWS 3SP/4SP/R12/4SH Sans dénuder
 Raccordi Compatti Serie BWS 3SP/4SP/R12/4SH senza spellatura

Conexiones una sola pieza JIC 37º ▪ One piece JIC 37º fittings ▪ Embouts pré-sertis JIC 37º ▪ Raccordi compatti JIC 37º | 60



PIPE FITTINGS

Conexiones una sola pieza ORFS ▪ One piece ORFS fittings ▪ Embouts pré-sertis ORFS ▪ Raccordi compatti ORFS | 61



PIPE FITTINGS II

Conexiones una sola pieza NPT-NPSM ▪ One piece NPT-NPSM fittings ▪ Embouts pré-sertis NPT-NPSM ▪ Raccordi compatti NPT-NPSM | 62



ADAPTORS

Conexiones una sola pieza Bidas SAE ▪ One piece SAE Flanges fittings/ Code 61 & 62 ▪ Embouts pré-sertis Bidas SAE ▪ Raccordi compatti Flange SAE | 63



WELDING FITTINGS

Conexiones una sola pieza Métricas ▪ One piece Metric fittings ▪ Embouts pré-sertis Métriques ▪ Raccordi compatti Metrici | 64



INDUSTRIAL FITTINGS

Conexiones una sola pieza BSP ▪ One piece BSP fittings ▪ Embouts pré-sertis BSP ▪ Raccordi compatti BSP | 65



ACCESSORIES

CONTROL COMPONENTS

FLOW MEASURING

TRALE LOK

Conexiones una pieza Serie BW+ R13/R15 No Pelar

One piece fittings BW+ Series R13/R15 No Skive
Embouts R13/R15 Série BW+ Sans denuder
Raccordi R13/R15 Serie BW+ senza spellatura

Conexiones JIC 37º ▪ JIC 37º fittings ▪ Embouts JIC 37º ▪ Raccordi JIC 37º

| 67



Conexiones ORFS ▪ ORFS fittings ▪ Embouts ORFS ▪ Raccordi ORFS

| 67



Conexiones NPT/NPSM ▪ NPT/NPSM fittings ▪ Embouts NPT/NPSM ▪ Raccordi NPT/NPSM

| 68



Bridas SAE ▪ SAE Flanges ▪ Brides SAE ▪ Flange SAE

| 68



Conexiones BSP ▪ BSP fittings ▪ Embouts BSP ▪ Raccordi BSP

| 69



Conexiones una sola pieza R7/ R8/ Elastómero malla metálica

One piece fittings R7/R8 & Elastomer Braid of steel wire
 Embouts pré-sertis R7/R8 et Elastomère tresse métallique
 Raccordi compatti serie R7/R8 e elastomero treccia metallica

Conexiones una sola pieza R7/R8 JIC 37º ▪ 37º JIC One piece fittings R7/R8 ▪ Embouts pré-sertis R7/R8 JIC 37º ▪ Raccordi compatti serie R7/R8 JIC sede 37º | 70



87242 87138 87140 87142 87139

Conexiones una sola pieza R7/R8 ORFS ▪ ORFS One piece fittings R7/R8 ▪ Embouts pré-sertis R7/R8 ORFS ▪ Raccordi compatti serie R7/R8 ORFS | 71



87900 87907 87912 87908

Conexiones una sola pieza R7/R8 NPT-NPSM ▪ NPT-NPSM One piece fittings R7/R8 ▪ Embouts pré-sertis R7/R8 NPT-NPSM ▪ Raccordi compatti serie R7/R8 NPT-NPSM | 72



87361 87262 87161 87261 87263

Conexiones una sola pieza R7/R8 Métricas ▪ Metric One piece fittings R7/R8 ▪ Embouts pré-sertis R7/R8 Métriques ▪ Raccordi compatti serie R7/R8 Metrici | 73



87804 87305 87203 87306

Conexiones una sola pieza R7/R8 BSP ▪ BSP One piece fittings R7/R8 ▪ Embouts pré-sertis R7/R8 BSP ▪ Raccordi compatti serie R7/R8 BSP | 74



87400 87107 87112 87100 87108

Conexiones una sola pieza PTFE Liso / R14

One piece fittings for Smooth PTFE / R14
Embouts pré-sertis pour PTFE lisse / R14
Raccordi compatti per PTFE liscio / R14

Conexiones una sola pieza PTFE liso / R14 JIC 37º ▪ 37º JIC One piece fittings smooth PTFE / R14 ▪ Embouts pré-sertis PTFE lisse / R14 JIC 37º ▪ Raccordi compatti serie PTFE liscio / R14 JIC 37º

75



86242 86138 86140 86142 86139

Conexiones una sola pieza PTFE liso / R14 ORFS ▪ ORFS One piece fittings smooth PTFE / R14 ▪ Embouts pré-sertis PTFE lisse / R14 ORFS ▪ Raccordi compatti serie PTFE liscio / R14 ORFS

76



86900 86907 86912 86908

Conexiones una sola pieza PTFE liso / R14 NPT-NPSM ▪ NPT-NPSM One piece fittings smooth PTFE / R14 ▪ Embouts pré-sertis PTFE lisse / R14 NPT-NPSM ▪ Raccordi compatti serie PTFE liscio / R14 NPT-NPSM

77



86361 86262 86161 86261 86263

Conexiones una sola pieza PTFE liso / R14 Métricas ▪ Metric One piece fittings smooth PTFE / R14 ▪ Embouts pré-sertis PTFE lisse / R14 Métriques ▪ Raccordi compatti serie PTFE liscio / R14 Metrici

78



86804 86305 86203 86306

Conexiones una sola pieza PTFE liso / R14 BSP ▪ BSP One piece fittings smooth PTFE / R14 ▪ Embouts pré-sertis PTFE lisse / R14 BSP ▪ Raccordi compatti serie PTFE liscio / R14 BSP

79



86400 86107 86112 86100 86108

Conexiones una sola pieza PTFE liso / R14 Espiga Lisa ▪ One piece fittings standpipe / R14 ▪ Embouts pré-sertis PTFE lisse / R14 embout lisse ▪ Raccordi compatti serie PTFE liscio / R14 estremitá tubolare

79



86159

Conexiones una sola pieza PTFE Corrugado

One piece fittings for convoluted PTFE
Embouts pré-sertis pour PTFE convoluté
Raccordi compatti per PTFE corrugato

Conexiones una sola pieza PTFE Corrugado JIC 37º ▪ One piece fittings for convoluted PTFE JIC 37º ▪ Embouts pré-sertis pour PTFE convoluté JIC 37º ▪ Raccordi compatti serie PTFE convoluto JIC 37º

80



85242 85138 85140 85142 85139

PIPE
FITTINGS

Conexiones una sola pieza PTFE Corrugado ORFS ▪ One piece fittings for convoluted PTFE ORFS ▪ Embouts pré-sertis pour PTFE convoluté ORFS ▪ Raccordi compatti serie PTFE convoluto ORFS

81



85900 85907 85912 85908

PIPE
FITTINGS II

Conexiones una sola pieza PTFE Corrugado NPT-NPSM ▪ One piece fittings for convoluted PTFE NPT-NPSM ▪ Embouts pré-sertis pour PTFE convoluté NPT-NPSM ▪ Raccordi compatti serie PTFE convoluto NPT-NPSM

82



85361 85262 85161 85261 85263

ADAPTORS

Conexiones una sola pieza PTFE Corrugado Métricas ▪ One piece fittings for convoluted PTFE Metrical ▪ Embouts pré-sertis pour PTFE convoluté Métriques ▪ Raccordi compatti serie PTFE convoluto METRICI

83



85804 85305 85203 85306

WELDING
FITTINGS

Conexiones una sola pieza PTFE Corrugado BSP ▪ One piece fittings for convoluted PTFE BSP ▪ Embouts pré-sertis pour PTFE convoluté BSP ▪ Raccordi compatti serie PTFE convoluto BSP

84



85400 85107 85112 85100 85108

INDUSTRIAL
FITTINGS

ACCESSORIES

CONTROL
COMPONENTS

FLOW
MEASURING

TRALE LOK

Conexiones Reusables

Reusable series
Embouts série récupérable
Serie Recuperabile

Conexiones una sola pieza Reusables ▪ Reusable One Piece fittings ▪ Embouts série récupérable 1 pièce ▪ Raccordi compatti recuperabile

85



Z3J...R2T

Z2NPT...R2T

Casquillos reusables ▪ Crimping ferrules ▪ Jupes à sertir ▪ Boccole recuperabili

85



Z1G...R1T

Z1G...R2T

Conexiones BSP ▪ Reusable BSP ▪ Récuperables BSP ▪ Raccordi recuperabili BSP

85



Z3G

Z90G

Z2G

Conexiones JIC 37° ▪ Reusable JIC 37° ▪ Récuperables JIC 37° ▪ Raccordi recuperabili JIC

86



Z3J

Z2J

Z3J90

Z3J45

Conexiones NPT ▪ Reusable NPT ▪ Récuperables NPT ▪ Raccordi recuperabili NPT

86



Z2NPT

Conexiones Métricas ▪ Reusable Metric ▪ Récuperables Métriques ▪ Raccordi recuperabili Metrici

86



ZE

Conexiones R5 ▪ Reusable R5 ▪ Récuperables R5 ▪ Raccordi recuperabili R5

87



Z3J...R5

Z3J90...R5

Z2P...R5

Z3J45...R5

Conexiones Push-On

Push-On Fittings
Embouts Push-On
Raccordi Serie Push-On

Conexiones Push-On BSP ▪ Push-on BSP fittings ▪ Embouts Push-on BSP ▪ Raccordi Serie Push-on BSP | 88



89100

89112

PIPE
FITTINGS

Conexiones Push-On JIC 37º ▪ Push-on 37º JIC fittings ▪ Embouts Push-on JIC 37º ▪ Raccordi Serie Push-on JIC 37º | 88



89142

89140

PIPE
FITTINGS II

Conexiones Push-On NPT ▪ Push-on NPT fittings ▪ Embouts Push-on NPT ▪ Raccordi Serie Push-on NPT | 88



89161

ADAPTORS

Conexiones Push-On Métricas ▪ Push-on Metric fittings ▪ Embouts Push-on Métriques ▪ Raccordi Serie Push-on Metrici | 88



89804

89203

WELDING
FITTINGS

INDUSTRIAL
FITTINGS

ACCESSORIES

CONTROL
COMPONENTS

FLOW
MEASURING

TRALE LOK

Conexiones Alta Presión (700 bar)

High pressure 700 bar fittings
Embouts haute pression 700 bar
Raccordi Altissima pressione (700 bar)

Casquillos para prensar ▪ Ferrules ▪ Jupes à sertir ▪ Boccole

| 89



Z71012

Conexiones BSP ▪ BSP Fittings ▪ Embouts BSP ▪ Raccordi BSP

| 89



Z74100

Z74112

Conexiones NPSM - NPT ▪ NPSM - NPT Fittings ▪ Embouts NPSM - NPT ▪ Raccordi NPSM - NPT

| 89



Z74261

Z74161

Conexiones JIC 37° ▪ JIC 37° Fittings ▪ Embouts JIC 37° ▪ Raccordi JIC 37°

| 89



Z74142

Z74140

Conexiones Métricas ▪ Metric Fittings ▪ Embouts métriques ▪ Raccordi Metrici

| 89



Z74804

Z74203

Conexiones Standard

Standard series
Embouts série standard
Serie Standard

Casquillos R1AT/R2AT/ 1SN/2SN/ R16/2SC/3TE

Ferrules R1AT/R2AT/1SN/2SN/R16/2SC/3TE

Jupes R1AT/R2AT/1SN/2SN/R16/2SC/3TE

Boccole pressare per R1AT/R2AT/1SN/2SN/
R16/2SC/3TE



DN	Referencia Part n°
3/16"-R1AT	810200300*
3/16"-R2AT	810300300*
3/16" NEW	ZPF221200300
1/4"	ZPF221200400
5/16"	ZPF221200500
3/8"	ZPF221200600
1/2"	ZPF221200800
5/8"	ZPF221201000
3/4"	ZPF221201200
1"	ZPF221201600
1"1/4	ZPF221202000
1"1/2	ZPF221202400
2"	ZPF221203200
2"1/2	ZPF221204000
3"	ZPF221204800

* Hasta fin de existencias / Until end of stock / Jusqu'à la fin du stock / Fino ad esaurimento

Casquillos R1A-1ST

Ferrules R1A-1ST

Jupes R1A-1ST

Boccole pressare per R1A-1ST

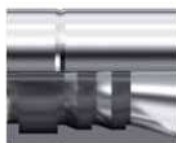

DN	Referencia Part n°
3/16"	820030300
1/4"	820030400
5/16"	820030500
3/8"	820030600
1/2"	820030800
5/8"	820031000
3/4"	820031200
1"	820031600
1"1/4	820032000
1"1/2	820032400
2"	820033200

Casquillos R4

Ferrules R4

Jupes R4

Boccole pressare per R4



DN	Referencia Part n°
3/4"	ZPF221201200R4

Para otras medidas, consultar tablas de prensado en nuestra web. / For other sizes, p
crimping table on our website. / Pour les autres dimensions, voir tableau de sertissage disp
web. / Per altre dimensioni, vedere tabella di pressatura nel ns. sito web

ut the
otre site

Casquillos 1SC/1SN/2SC/R6/2TE/R17

Ferrules 1SC/1SN/2SC/R6/2TE/R17

Jupes 1SC/1SN/2SC/R6/2TE/R17

Boccole pressare per 1SC/1SN/2SC/R6/2TE/R17



DN	Referencia Part n°
1/4"	ZSC21120400
5/16"	ZSC21120500
3/8"	ZSC21120600
1/2"	ZSC21120800
5/8"	ZSC21121000
3/4"	ZSC21121200
1"	ZSC21121600

Casquillos R2A-2ST/4SP-R9R / R12

Ferrules R2A-2ST/4SP-R9R / R12

Jupes R2A-2ST/4SP-R9R / R12

Boccole pressare per R2A-2ST/4SP-R9R / R12



DN	Referencia Part n°
3/16" - R2A	820060300
1/4"	ZPF122400400
5/16"	ZPF122400500
3/8"	ZPF122400600
1/2"	ZPF122400800
5/8"	ZPF122401000
3/4"	ZPF122401200
1"	ZPF122401600
1"1/4	ZPF122402000
1"1/2	ZPF122402400
2"	ZPF122403200

Casquillos 3SP/4SP/R12/4SH no pelar

Ferrules 3SP/4SP/R12/4SH non skive

Jupes 3SP/4SP/R12/4SH sans dénudage

Boccole pressare per 3SP/4SP/R12/4SH senza
spellatura



DN	Referencia Part n°
3/8"	ZPF222400600
1/2"	ZPF222400800
5/8"	ZPF222401000
3/4"	ZPF222401200
1"	ZPF222401600
1" 1/4	ZPF222402000
1" 1/2	ZPF222402400
2"	ZPF222403200

Conexiones Standard

Standard series
Embouts série standard
Serie Standard

Casquillos R7/R8 y elastómero malla metálica / R6

Ferrules R7/R8 and metallic braid / R6

Jupes R7/R8 et tresse métallique / R6

Boccole pressare per R7/R8 e elastomero treccia metallica / R6



DN	Referencia Part n°
1/8"	810140200
3/16"	810140300
1/4"	810140400
5/16"	810140500
3/8"	810140600
1/2"	810140800
5/8"	810141000
3/4"	810141200
1"	810141600

Casquillos para mangueras Ecology y limpieza de alc

Ferrules for Ecology hose and Sewer Jetting hose

Jupes pour tuyau Ecology et tuyau Hydrocurage

Boccole pressare per tubi Ecology e pulizia fossa biologica



DN	Referencia Part n°
3/4"	Z212001200
1"	Z212001600
1"1/4	Z212002000

Casquillos PTFE Liso

Ferrules for smooth PTFE

Jupes PTFE lisse

Boccole pressare per PTFE liscio



DN	Referencia Part n°
1/8"	810400100
3/16"	810400300
1/4"	810400400
5/16"	810400500
3/8"	810400600
1/2"	810400800
5/8"	810401000
3/4"	810401200
1"	810401600

Casquillos PTFE Corrugado

Ferrules for convoluted PTFE

Jupes PTFE convoluté

Boccole pressare per PTFE corrugato



DN	Referencia Part n°
1/4"	810410400
5/16"	810410500
3/8"	810410600
1/2"	810410800
5/8"	810411000
3/4"	810411201
1"	810411600
1"1/4	810412000
1"1/2	810412400
2"	810413200
2"1/2	810414000

Casquillos PTFE Liso doble malla

Ferrules for double braid smooth PTFE

Jupes PTFE lisse double tresse

Boccole pressare per PTFE liscio doppia treccia



DN	Referencia Part n°
1/4"	810450400
3/8"	810450600

Para otros tamaños, consultar tabla de prensado en nuestra web. / For other size crimping table on our website. / Pour les autres dimensions, voir tableau de sertissage t the tre site web. / Per altre dimensioni, vedere tabella di pressatura nel ns. sito web

Conexiones Standard

Standard series
Embouts série standard
Serie Standard

Casquillos PTFE Liso, perfil liso

Ferrules for smooth PTFE, smooth profile

Jupes PTFE lisse, profil lisse

Boccole PTFE liscio con interno liscio



DN	Referencia Part n°
1/4"	880400400
5/16"	880400500
3/8"	880400600
1/2"	880400800
5/8"	880401000

Casquillos PTFE Corrugado, perfil liso

Ferrules for convoluted PTFE, smooth profile

Jupes PTFE convoluté, profil lisse

Boccole PTFE corrugato con interno liscio



DN	Referencia Part n°
1/4"	880410400
5/16"	880410500
3/8"	880410600
1/2"	880410800
5/8"	880411000
3/4"	880411200

CASQUILLOS PERFIL LISO FERRULES WITH SMOOTH PROFILE

➡ FACIL MONTAJE

➡ EASY ASSEMBLY

➡ VALIDO PARA CONEXIONES DE 1 Y 2 PIEZAS

➡ SUITABLE FOR 1 & 2 PIECE FITTINGS



Conexiones Standard

Standard series
Emboutis série standard
Serie Standard

Hembras giratorias rectas rosca BSP cono 60°

BSP Swivel female 60° cone

Femelle gaz cylindrique BSP 60°

Femmina diritta BSP sede 60°



DN	ROSCA THREAD	Referencia Part n°
3,2 mm	1/8" BSP	841000201
1/8"	1/8" BSP	841000202
3/16"	1/8" BSP	841000203
1/4"	1/8" BSP	841000204
3/16"	1/4" BSP	841000403
1/4"	1/4" BSP	841000404
5/16"	1/4" BSP	841000405
3/8"	1/4" BSP	841000406
1/4"	3/8" BSP	841000604
5/16"	3/8" BSP	841000605
3/8"	3/8" BSP	841000606
1/2"	3/8" BSP	841000608
1/4"	1/2" BSP	NEW 841000804
3/8"	1/2" BSP	841000806
1/2"	1/2" BSP	841000808
5/8"	1/2" BSP	841000810
1/2"	5/8" BSP	841001008
5/8"	5/8" BSP	841001010
1/2"	3/4" BSP	841001208
5/8"	3/4" BSP	841001210
3/4"	3/4" BSP	841001212
5/8"	1" BSP	841001610
3/4"	1" BSP	841001612
1"	1" BSP	841001616
1"	1"1/4 BSP	841002016
1"1/4"	1"1/4 BSP	841002020
1"1/4"	1"1/2 BSP	841002420
1"1/2"	1"1/2 BSP	841002424
1"1/2"	2" BSP	841003224
2"	2" BSP	841003232
2"	2"1/2 BSP	841004032
2"1/2"	2"1/2 BSP	841004040
3"	3" BSP	841004848

Hembras giratorias rectas rosca BSP cono 60° con junt

BSP Swivel female 60° cone with o-ring

Femelle gaz cylindrique BSP 60° avec o-ring

Femmina diritta BSP sede 60° con o'ring



DN	ROSCA THREAD	Referencia Part n°
1/4"	1/4" BSP	841100404
3/8"	3/8" BSP	841100606
3/8"	1/2" BSP	841100806
1/2"	1/2" BSP	841100808
5/8"	1/2" BSP	841100810
1/2"	3/4" BSP	841101208
5/8"	3/4" BSP	841101210
3/4"	3/4" BSP	841101212
1"	1" BSP	841101616
1"1/4"	1"1/4 BSP	841102020
1"1/2"	1"1/2 BSP	841102424
2"	2" BSP	841103232

Hembras giratorias rectas rosca BSP asiento plano

BSP Swivel female flat seat

Femelle fond plat BSP

Femmina BSP sede piana



DN	ROSCA THREAD	Referencia Part n°
1/4"	1/4" BSP	842000404
1/4"	3/8" BSP	842000604
5/16"	3/8" BSP	842000605
3/8"	3/8" BSP	842000606
1/2"	3/8" BSP	842000608
1/4"	1/2" BSP	842000804
3/8"	1/2" BSP	842000806
1/2"	1/2" BSP	842000808
1/2"	3/4" BSP	842001208
5/8"	3/4" BSP	842001210
3/4"	3/4" BSP	842001212
5/8"	1" BSP	842001610
3/4"	1" BSP	842001612
1"	1" BSP	842001616
1"	1"1/4 BSP	842002016
1"1/4"	1"1/4 BSP	842002020
1"1/2"	1"1/2 BSP	842002424
2"	2" BSP	842003232

Hembras giratorias recta rosca BSP cono 60° doble h

Double hexagonal BSP Swivel female cone 60°

Femelle BSP cône 60° double hexagonal

Femmina diritta BSP sede 60° doppio esagono



DN	ROSCA THREAD	Referencia Part n°
1/4"	1/4" BSP	844000404
5/16"	3/8" BSP	844000605
3/8"	3/8" BSP	844000606
1/2"	1/2" BSP	844000808
3/4"	3/4" BSP	844001212
1"	1" BSP	844001616
1"1/4"	1"1/4 BSP	844002020
1"1/2"	1"1/2 BSP	844002424
2"	2" BSP	844003232

CRIMPING FITTINGS
FOR HOSES

PIPE
FITTINGS

PIPE
FITTINGS II

ADAPTORS

WELDING
FITTINGS

INDUSTRIAL
FITTINGS

ACCESSORIES

CONTROL
COMPONENTS

FLOW
MEASURING

TRALE LOK

Conexiones Standard

Standard series
Embouts série standard
Serie Standard

Hembras giratorias 90° rosca BSP cono 60°

BSP Swivel female 60° cone (90° Elbow)

Coude 90° femelle gaz cyl. BSP 60°

Femmina 90° BSP sede 60°



DN	ROSCA THREAD	Referencia Part n°
3/16"	1/8" BSP	841070203*
1/4"	1/8" BSP	841070204
3/16"	1/4" BSP	841070403
1/4"	1/4" BSP	841070404
5/16"	1/4" BSP	841070405*
3/8"	1/4" BSP	841070406
1/4"	3/8" BSP	841070604
5/16"	3/8" BSP	841070605
3/8"	3/8" BSP	841070606
1/2"	3/8" BSP	841070608
1/4"	1/2" BSP	841070804
3/8"	1/2" BSP	841070806
1/2"	1/2" BSP	841070808
5/8"	5/8" BSP	841071010
1/2"	3/4" BSP	841071208
5/8"	3/4" BSP	841071210
3/4"	3/4" BSP	841071212
3/4"	1" BSP	841071612
1"	1" BSP	841071616
1"	1" 1/4 BSP	841072016
1" 1/4"	1" 1/4 BSP	841072020
1" 1/2"	1" 1/2 BSP	841072424
2"	2" BSP	841073232

*Pieza soldada / *Welded piece / *Pièce soudé / *Tubo soldato

Hembras giratorias 90° rosca BSP asiento plano

BSP Swivel female flat seat (90° Elbow)

Coude 90° femelle fond plat BSP

Femmina 90° BSP sede plana



DN	ROSCA THREAD	Referencia Part n°
1/4"	1/4" BSP	842070404
5/16"	3/8" BSP	842070605
3/8"	3/8" BSP	842070606
1/2"	1/2" BSP	842070808
3/4"	3/4" BSP	842071212
3/4"	1" BSP	842071612
1"	1" BSP	842071616
1" 1/4"	1" 1/4 BSP	842072020
1" 1/2"	1" 1/2 BSP	842072424
2"	2" BSP	842073232

Hembras giratorias 45° rosca BSP cono 60°

BSP Swivel female 60° cone (45° Elbow)

Coude 45° femelle gaz cyl. BSP 60°

Femmina 45° BSP sede 60°



DN	ROSCA THREAD	Referencia Part n°
3/16"	1/4" BSP	841080403
1/4"	1/4" BSP	841080404
1/4"	3/8" BSP	841080604
5/16"	3/8" BSP	841080605
3/8"	3/8" BSP	841080606
1/4"	1/2" BSP	841080804
3/8"	1/2" BSP	841080806
1/2"	1/2" BSP	841080808
5/8"	5/8" BSP	841081010
1/2"	3/4" BSP	841081208
5/8"	3/4" BSP	841081210
3/4"	3/4" BSP	841081212
3/4"	1" BSP	841081612
1"	1" BSP	841081616
1"	1" 1/4 BSP	841082016
1" 1/4"	1" 1/4 BSP	841082020
1" 1/2"	1" 1/2 BSP	841082424
2"	2" BSP	841083232

Hembras giratorias 45° rosca BSP asiento plano

BSP Swivel female flat seat (45° Elbow)

Coude 45° femelle fond plat BSP

Femmina 45° BSP sede plana



DN	ROSCA THREAD	Referencia Part n°
1/4"	1/4" BSP	842080404
5/16"	3/8" BSP	842080605
3/8"	3/8" BSP	842080606
3/8"	1/2" BSP	842080806
1/2"	1/2" BSP	842080808
3/4"	3/4" BSP	842081212
3/4"	1" BSP	842081612
1"	1" BSP	842081616
1" 1/4"	1" 1/4 BSP	842082020
1" 1/2"	1" 1/2 BSP	842082424
2"	2" BSP	842083232

Hembras giratorias 90° compactas rosca BSP cono 60°

BSP swivel female 60° (90° Compact Elbow)

Coude femelle 90° compact BSP cône 60°

Femmina 90° BSP compatta



DN	ROSCA THREAD	Referencia Part n°
1/4"	1/4" BSP	841270404
3/8"	3/8" BSP	841270606
1/2"	1/2" BSP	841270808
3/4"	3/4" BSP	841271212
1"	1" BSP	841271616

Conexiones Standard

Standard series
Emboutis série standard
Serie Standard

Hembras giratorias 90° rosca BSP cono 60° con junta tórica

BSP Swivel female 60° cone with o-ring (90° Elbow)

Coude 90° femelle gaz cyl. BSP 60° avec o-ring

Femmina 90° BSP sede 60° con o'ring



DN	ROSCA THREAD	Referencia Part n°
1/4"	1/4" BSP	841170404
3/8"	3/8" BSP	841170606
3/8"	1/2" BSP	841170806
1/2"	1/2" BSP	841170808
1/2"	3/4" BSP	841171208
5/8"	3/4" BSP	841171210
3/4"	3/4" BSP	841171212
1"	1" BSP	841171616
1"1/4	1"1/4 BSP	841172020
1"1/2	1"1/2 BSP	841172424
2"	2" BSP	841173232

Hembras giratorias 45° rosca BSP cono 60° con junta tórica

BSP Swivel female 60° cone with o-ring (45° Elbow)

Coude 45° femelle gaz cyl. BSP 60° avec o-ring

Femmina 45° BSP sede 60° con o'ring



DN	ROSCA THREAD	Referencia Part n°
1/4"	1/4" BSP	841180404
3/8"	3/8" BSP	841180606
3/8"	1/2" BSP	841180806
1/2"	1/2" BSP	841180808
1/2"	3/4" BSP	841181208
5/8"	3/4" BSP	841181210
3/4"	3/4" BSP	841181212
1"	1" BSP	841181616
1"1/4	1"1/4 BSP	841182020
1"1/2	1"1/2 BSP	841182424
2"	2" BSP	841183232

Juntas para hembra giratoria BSP FKM verde

O'ring for swivel female BSP FKM green

Joint torique pour femelle tournante BSP FKM vert

O'ring FKM verde per femmina girevole BSP



ROSCA THREAD	TAMAÑO SIZE	Referencia Part n°
1/4" BSP	6X1	JTVBSP04
3/8" BSP	8,1X1,6	JTVBSP06
1/2" BSP	12,1X1,6	JTVBSP08
5/8" BSP	13,1X1,6	JTVBSP10
3/4" BSP	17,1X1,6	JTVBSP12
1" BSP	22,1X1,6	JTVBSP16
1"1/4 BSP	29,1X1,6	JTVBSP20
1"1/2 BSP	35,1X1,6	JTVBSP24
2" BSP	47,35X1,78	JTVBSP32

Conexiones Standard

Standard series
Embouts série standard
Serie Standard

Machos rosca cilíndrica BSP asiento plano

BSP Male flat seat

Mâle BSP fond plat

Maschio BSP sede piana



DN	ROSCA THREAD	Referencia Part n°
3/16"	1/4" BSP	842120403
1/4"	1/4" BSP	842120404
5/16"	3/8" BSP	842120605
3/8"	3/8" BSP	842120606
1/2"	3/8" BSP	842120608
3/8"	1/2" BSP	842120806
1/2"	1/2" BSP	842120808
5/8"	5/8" BSP	842121010
3/4"	3/4" BSP	842121212
3/4"	1" BSP	842121612
1"	1" BSP	842121616
1"	1" 1/4 BSP	842122016
1"1/4"	1"1/4 BSP	842122020
1"1/2"	1"1/2 BSP	842122424
2"	2" BSP	842123232

Machos rosca cilíndrica BSP cono 60°

BSP Male-parallel 60° cone

Mâle BSP cône 60°

Maschio BSP cilindrico sede 60°



DN	ROSCA THREAD	Referencia Part n°
3/16"	1/8" BSP	841120203
1/4"	1/8" BSP	841120204
3/16"	1/4" BSP	841120403
1/4"	1/4" BSP	841120404
5/16"	1/4" BSP	841120405
3/8"	1/4" BSP	841120406
1/4"	3/8" BSP	841120604
5/16"	3/8" BSP	841120605
3/8"	3/8" BSP	841120606
1/2"	3/8" BSP	841120608
3/8"	1/2" BSP	841120806
1/2"	1/2" BSP	841120808
5/8"	5/8" BSP	841121010
5/8"	3/4" BSP	841121210
3/4"	3/4" BSP	841121212
1"	3/4" BSP	NEW 841121216
3/4"	1" BSP	841121612
1"	1" BSP	841121616
1"	1" 1/4 BSP	841122016
1"1/4"	1"1/4 BSP	841122020
1"1/4"	1"1/2 BSP	841122420
1"1/2"	1"1/2 BSP	841122424
2"	1" 1/2 BSP	841122432
2"	2" BSP	841123232
2" 1/2"	2" 1/2 BSP	841124040

Macho rosca cónica BSPT cono 60°

Male BSPT tapered

Mâle gaz conique BSPT 60°

Maschio conico BSPT sede 60°



DN	ROSCA THREAD	Referencia Part n°
1/4"	1/4" BSPT	841140404
5/16"	1/4" BSPT	841140405
3/8"	1/4" BSPT	841140406
1/4"	3/8" BSPT	841140604
5/16"	3/8" BSPT	841140605
3/8"	3/8" BSPT	841140606
1/2"	3/8" BSPT	841140608
3/8"	1/2" BSPT	841140806
1/2"	1/2" BSPT	841140808
5/8"	1/2" BSPT	841140810
3/4"	1/2" BSPT	841140812
1/2"	3/4" BSPT	841141208
5/8"	3/4" BSPT	841141210
3/4"	3/4" BSPT	841141212
3/4"	1" BSPT	841141612
1"	1" BSPT	841141616
1"	1"1/4 BSPT	841142016
1"1/4"	1"1/4 BSPT	841142020
1"1/4"	1"1/2 BSPT	841142420
1"1/2"	1"1/2 BSPT	841142424
2"	2" BSPT	841143232

Conexiones Standard

Standard series
Embouts série standard
Serie Standard

Hembras giratorias rectas rosca NPSM cono 60° doble hexagonal

Double hexagonal NPSM Swivel female cone 60°

Femelle NPSM cône 60° double hexagonal

Femmina diritta NPSM sede 60° doppio esagono



DN	ROSCA THREAD	Referencia Part n°
1/4"	1/4" 18h NPSM	843610404
3/8"	3/8" 18h NPSM	843610606
1/2"	1/2" 14h NPSM	843610808
3/4"	3/4" 14h NPSM	843611212
1"	1" - 11 1/2h NPSM	843611616

Hembras giratorias rectas rosca NPSM cono 60°

NPSM Swivel female 60° cone

Femelle NPSM cône 60°

Femmina diritta NPSM sede 60°



DN	ROSCA THREAD	Referencia Part n°
3/16"	1/4" 18h NPSM	842610403
1/4"	1/4" 18h NPSM	842610404
3/8"	3/8" 18h NPSM	842610606
3/8"	1/2" 14h NPSM	NEW 842610806
1/2"	1/2" 14h NPSM	842610808
3/4"	3/4" 14h NPSM	842611212
3/4"	1"-11 1/2h NPSM	842611612
1"	1"-11 1/2h NPSM	842611616
1"1/4"	1"1/4-11 1/2h NPSM	842612020
1"1/2"	1"1/2-11 1/2h NPSM	842612424

Hembras giratorias 90° rosca NPSM cono 60°

NPSM Swivel female 60° cone (90° Elbow)

Coûde 90° femelle NPSM cône 60°

Femmina 90° NPSM sede 60°



DN	ROSCA THREAD	Referencia Part n°
1/4"	1/4" 18h NPSM	842620404
3/8"	3/8" 18h NPSM	842620606
1/2"	1/2" 14h NPSM	842620808
3/4"	3/4" 14h NPSM	842621212
1"	1"-11 1/2h NPSM	842621616

Hembras giratorias 45° rosca NPSM cono 60°

NPSM Swivel female 60° cone (45° Elbow)

Coûde 45° femelle NPSM cône 60°

Femmina 45° NPSM sede 60°



DN	ROSCA THREAD	Referencia Part n°
1/4"	1/4" 18h NPSM	842630404
3/8"	3/8" 18h NPSM	842630606
1/2"	1/2" 14h NPSM	842630808
3/4"	3/4" 14h NPSM	842631212
1"	1"-11 1/2h NPSM	842631616

Machos rosca cónica NPT

NPT Male pipe straight

Embout mâle conique NPT (BRIGGS)

Maschio conico NPT sede 60°



DN	ROSCA THREAD	Referencia Part n°
1/4"	1/8" NPT	841610204
3/16"	1/4" NPT	841610403
1/4"	1/4" NPT	841610404
5/16"	1/4" NPT	841610405
3/8"	1/4" NPT	841610406
1/4"	3/8" NPT	841610604
5/16"	3/8" NPT	841610605
3/8"	3/8" NPT	841610606
1/2"	3/8" NPT	841610608
1/4"	1/2" NPT	841610804
3/8"	1/2" NPT	841610806
1/2"	1/2" NPT	841610808
5/8"	1/2" NPT	841610810
3/4"	1/2" NPT	841610812
1/2"	3/4" NPT	841611208
5/8"	3/4" NPT	841611210
3/4"	3/4" NPT	841611212
1"	3/4" NPT	841611216
3/4"	1" NPT	841611612
1"	1" NPT	841611616
1"	1"1/4 NPT	841612016
1"1/4"	1"1/4 NPT	841612020
1"	1"1/2 NPT	841612416
1"1/4"	1"1/2 NPT	841612420
1"1/2"	1"1/2 NPT	841612424
2"	2" NPT	841613232

Machos giratorios NPT

Swivel male NPT

Mâle tournant NPT

Maschio girevole NPT



DN	ROSCA THREAD	Referencia Part n°
1/4"	1/4" NPT	841650404
3/8"	3/8" NPT	841650606
3/8"	1/2" NPT	841650806
1/2"	1/2" NPT	841650808
3/4"	1/2" NPT	841650812
1/2"	3/4" NPT	841651208
3/4"	3/4" NPT	841651212
3/4"	1" NPT	841651612
1"	1" NPT	841651616

Conexiones Standard

Standard series
Embouts série standard
Serie Standard

Hembras giratorias recta JIC 37° doble hexagonal

Double hexagonal JIC 37° Swivel female

Femelle JIC 37° double hexagonal

Femmina diritta JIC 37° doppio esagono



DN	ROSCA THREAD	Referencia Part n°
3/16"	7/16" 20h UNF	842420703
1/4"	7/16" 20h UNF	842420704
5/16"	7/16" 20h UNF	842420705
3/8"	7/16" 20h UNF	842420706
1/4"	1/2" 20h UNF	842420804
5/16"	1/2" 20h UNF	842420805
3/8"	1/2" 20h UNF	842420806
1/4"	9/16" 18h UNF	842420904
5/16"	9/16" 18h UNF	842420905
3/8"	9/16" 18h UNF	842420906
3/8"	3/4" 16h UNF	842421206
1/2"	3/4" 16h UNF	842421208
5/8"	3/4" 16h UNF	842421210
3/4"	3/4" 16h UNF	842421212
1/2"	7/8" 14h UNF	842421408
5/8"	7/8" 14h UNF	842421410
3/4"	7/8" 14h UNF	842421412
1/2"	1 1/16" 12h UN	842421708
5/8"	1 1/16" 12h UN	842421710
3/4"	1 1/16" 12h UN	842421712
1"	1 1/16" 12h UN	842421716
3/4"	1 5/16" 12h UN	842422112
1"	1 5/16" 12h UN	842422116
1 1/4"	1 5/8" 12h UN	842422620
1 1/2"	1 7/8" 12h UN	842423024
2"	2 1/2" 12h UN	842424032

Hembras giratorias recta JIC 37°

JIC 37° Swivel female

Femelle droite JIC cône 37°

Femmina diritta JIC 37°



DN	ROSCA THREAD	Referencia Part n°
3.2 mm	7/16" 20h UNF	841420701
3/16"	7/16" 20h UNF	841420703
1/4"	7/16" 20h UNF	841420704
5/16"	7/16" 20h UNF	841420705
3/16"	1/2" 20h UNF	841420803
1/4"	1/2" 20h UNF	841420804
5/16"	1/2" 20h UNF	841420805
1/4"	9/16" 18h UNF	841420904
5/16"	9/16" 18h UNF	841420905
3/8"	9/16" 18h UNF	841420906
3/8"	3/4" 16h UNF	841421206
1/2"	3/4" 16h UNF	841421208
3/8"	7/8" 14h UNF	841421406
1/2"	7/8" 14h UNF	841421408
5/8"	7/8" 14h UNF	841421410
1/2"	1 1/16" 12h UN	841421708
5/8"	1 1/16" 12h UN	841421710
3/4"	1 1/16" 12h UN	841421712
1"	1 1/16" 12h UN	841421716
3/4"	1 5/16" 12h UN	841422112
1"	1 5/16" 12h UN	841422116
1"	1 5/8" 12h UN	841422616
1 1/4"	1 5/8" 12h UN	841422620
1 1/4"	1 7/8" 12h UN	841423020
1 1/2"	1 7/8" 12h UN	841423024
2"	2 1/2" 12h UN	841424032

Hembras giratorias 90° JIC 37°

JIC 37° Swivel female (90° Elbow)

Coude 90° femelle JIC cône 37°

Femmina 90° JIC sede 37°



DN	ROSCA THREAD	Referencia Part n°
3/16"	7/16" 20h UNF	841380703
1/4"	7/16" 20h UNF	841380704
5/16"	7/16" 20h UNF	841380705
1/4"	1/2" 20h UNF	841380804
5/16"	1/2" 20h UNF	841380805
1/4"	9/16" 18h UNF	841380904
5/16"	9/16" 18h UNF	841380905
3/8"	9/16" 18h UNF	841380906
3/8"	3/4" 16h UNF	841381206
1/2"	3/4" 16h UNF	841381208
3/8"	7/8" 14h UNF	841381406
1/2"	7/8" 14h UNF	841381408
5/8"	7/8" 14h UNF	841381410
1/2"	1 1/16" 12h UN	841381708
5/8"	1 1/16" 12h UN	841381710
3/4"	1 1/16" 12h UN	841381712
3/4"	1 5/16" 12h UN	841382112
1"	1 5/16" 12h UN	841382116
1"	1 5/8" 12h UN	841382616
1 1/4"	1 5/8" 12h UN	841382620
1 1/4"	1 7/8" 12h UN	841383020
1 1/2"	1 7/8" 12h UN	841383024
2"	2 1/2" 12h UN	841384032

Hembras giratorias 45° JIC 37°

JIC 37° Swivel female (45° Elbow)

Coude 45° femelle JIC cône 37°

Femmina 45° JIC sede 37°



DN	ROSCA THREAD	Referencia Part n°
3/16"	7/16" 20h UNF	841390703
1/4"	7/16" 20h UNF	841390704
1/4"	1/2" 20h UNF	841390804
5/16"	1/2" 20h UNF	841390805
1/4"	9/16" 18h UNF	841390904
5/16"	9/16" 18h UNF	841390905
3/8"	9/16" 18h UNF	841390906
3/8"	3/4" 16h UNF	841391206
1/2"	3/4" 16h UNF	841391208
3/8"	7/8" 14h UNF	841391406
1/2"	7/8" 14h UNF	841391408
5/8"	7/8" 14h UNF	841391410
5/8"	1 1/16" 12h UN	841391710
3/4"	1 1/16" 12h UN	841391712
3/4"	1 5/16" 12h UN	841392112
1"	1 5/16" 12h UN	841392116
1"	1 5/8" 12h UN	841392616
1 1/4"	1 5/8" 12h UN	841392620
1 1/4"	1 7/8" 12h UN	841393020
1 1/2"	1 7/8" 12h UN	841393024
2"	2 1/2" 12h UN	841394032

Conexiones Standard

Standard series
Emboutis série standard
Serie Standard

Machos rosca JIC cono 37°

Male JIC 37°

Mâle fixe JIC cône 37°

Maschio JIC 37°



DN	ROSCA THREAD	Referencia Part n°
3/16"	7/16" 20h UNF	841400703
1/4"	7/16" 20h UNF	841400704
1/4"	1/2" 20h UNF	841400804
5/16"	1/2" 20h UNF	841400805
1/4"	9/16" 18h UNF	841400904
5/16"	9/16" 18h UNF	841400905
3/8"	9/16" 18h UNF	841400906
1/4"	3/4" 16h UNF	841401204
3/8"	3/4" 16h UNF	841401206
1/2"	3/4" 16h UNF	841401208
3/8"	7/8" 14h UNF	841401406
1/2"	7/8" 14h UNF	841401408
5/8"	7/8" 14h UNF	841401410
5/8"	1"1/16 12h UN	841401710
3/4"	1"1/16 12h UN	841401712
1"	1"1/16 12h UN	841401716
3/4"	1"5/16 12h UN	841402112
1"	1"5/16 12h UN	841402116
1"	1"5/8 12h UN	841402616
1"1/4"	1"5/8 12h UN	841402620
1"1/2"	1"7/8 12h UN	841403024
2"	2"1/2 12h UN	841404032

Machos rosca JIC cono 37° con junta

Male JIC 37° with o'ring

Mâle fixe JIC cône 37° avec o'ring

Maschio JIC sede 37° con o'ring



DN	ROSCA THREAD	Referencia Part n°
1/4"	7/16" 20h UNF	841410704
3/8"	9/16" 18h UNF	841410906
1/2"	3/4" 16h UNF	841411208
3/4"	1"1/16 12h UN	841411712
1"	1"5/16 12h UN	841412116
1"1/4"	1"5/8 12h UN	841412620
1"1/2"	1"7/8 12h UN	841413024
2"	2"1/2 12h UN	841414032

Hembras giratorias 90° compactas JIC 37°

JIC 37° Swivel female (90° Compact Elbow)

Coude femelle 90° compact JIC cône 37°

Femmina 90° JIC sede 37° compatta



DN	ROSCA THREAD	Referencia Part n°
1/4"	7/16" 20h UNF	841370704
3/8"	9/16" 18h UNF	841370906
1/2"	3/4" 16h UNF	841371208
3/4"	1"1/16 12h UNF	841371712
1"	1"5/16 12h UNF	841372116

CRIMPING FITTINGS
FOR HOSES

PIPE
FITTINGS

PIPE
FITTINGS II

ADAPTORS

WELDING
FITTINGS

INDUSTRIAL
FITTINGS

ACCESSORIES

CONTROL
COMPONENTS

FLOW
MEASURING

TRALE LOK

Conexiones Standard

Standard series
Embouts série standard
Serie Standard

Hembras giratorias rectas DKOL rosca Métrica cono 24°

Metric female swivel L with o'ring 24° cone

Femelle Métrique L avec o'ring cône 24°

Femmina metrica sede 24°+O'ring serie leggera L



Hembras giratorias rectas DKOS rosca Métrica cono 24°

Metric female swivel S with o'ring 24° cone

Femelle Métrique S avec o'ring cône 24°

Femmina metrica sede 24°+O'ring serie pesante S



DN	TUBO PIPE	SERIE SERIES	ROSCA THREAD	Referencia Part n°
3/16"	6	L	M12x1,5	84804120603
1/4"	6	L	M12x1,5	84804120604
1/4"	8	L	M14x1,5	84804140804
5/16"	8	L	M14x1,5	84804140805
3/8"	8	L	M 14x1,5	84804140806
1/4"	10	L	M16x1,5	84804161004
5/16"	10	L	M16x1,5	84804161005
3/8"	10	L	M16x1,5	84804161006
1/4"	12	L	M18x1,5	84804181204
5/16"	12	L	M18x1,5	84804181205
3/8"	12	L	M18x1,5	84804181206
1/2"	12	L	M 18x1,5	84804181208
1/4"	15	L	M22x1,5	84804221504
5/16"	15	L	M22x1,5	84804221505
3/8"	15	L	M22x1,5	84804221506
1/2"	15	L	M22x1,5	84804221508
5/8"	15	L	M22x1,5	84804221510
3/8"	18	L	M26x1,5	84804261806
1/2"	18	L	M26x1,5	84804261808
5/8"	18	L	M26x1,5	84804261810
3/4"	18	L	M26x1,5	84804261812
1/2"	22	L	M30x2	84804302208
5/8"	22	L	M30x2	84804302210
3/4"	22	L	M30x2	84804302212
3/4"	28	L	M36x2	84804362812
1"	28	L	M36x2	84804362816
1"	35	L	M45x2	84804453516
1"1/4	35	L	M45x2	84804453520
1"1/4	42	L	M52x2	84804524220
1"1/2	42	L	M52x2	84804524224
2"	42	L	M52x2	84804524232

DN	TUBO PIPE	SERIE SERIES	ROSCA THREAD	Referencia Part n°
1/4"	6	S	M14x1,5	84804140604
1/4"	8	S	M16x1,5	84804160804
5/16"	8	S	M16x1,5	84804160805
3/8"	8	S	M16x1,5	84804160806
1/4"	10	S	M18x1,5	84804181004
5/16"	10	S	M18x1,5	84804181005
3/8"	10	S	M18x1,5	84804181006
1/4"	12	S	M20x1,5	84804201204
5/16"	12	S	M20x1,5	84804201205
3/8"	12	S	M20x1,5	84804201206
1/2"	12	S	M20x1,5	84804201208
5/16"	14	S	M22x1,5	84804221405
3/8"	14	S	M22x1,5	84804221406
1/2"	14	S	M22x1,5	84804221408
1/4"	16	S	M24x1,5	84804241604
5/16"	16	S	M24x1,5	84804241605
3/8"	16	S	M24x1,5	84804241606
1/2"	16	S	M24x1,5	84804241608
5/8"	16	S	M24x1,5	84804241610
1/2"	20	S	M30x2	84804302008
5/8"	20	S	M30x2	84804302010
3/4"	20	S	M30x2	84804302012
5/8"	25	S	M36x2	84804362510
3/4"	25	S	M36x2	84804362512
1"	25	S	M36x2	84804362516
3/4"	30	S	M42x2	84804423012
1"	30	S	M42x2	84804423016
1"1/4	38	S	M52x2	84804523820

Conexiones Standard

Standard series
Emboutis série standard
Serie Standard

Machos rosca Métrica cono 24°

Metric Male stud 24° cone

Mâle métrique cône 24°

Maschio Metrico sede 24°



DN	TUBO PIPE	SERIE SERIES	ROSCA THREAD	Referencia Part n°
1/4"	6	L	M12x1.5	84203120604
1/4"	8	L	M14x1.5	84203140804
1/4"	10	L	M16x1.5	84203161004
5/16"	10	L	M16x1.5	84203161005
3/8"	10	L	M16x1.5	84203161006
1/4"	12	L	M18x1.5	84203181204
5/16"	12	L	M18x1.5	84203181205
3/8"	12	L	M18x1.5	84203181206
3/8"	15	L	M22x1.5	84203221506
1/2"	15	L	M22x1.5	84203221508
1/2"	18	L	M26x1.5	84203261808
5/8"	18	L	M26x1.5	84203261810
3/4"	22	L	M30x2	84203302212
1"	28	L	M36x2	84203362816
1"1/4	35	L	M45x2	84203453520
1"1/2	42	L	M52x2	84203524224
1/4"	6	S	M14x1.5	84203140604
1/4"	8	S	M16x1.5	84203160804
1/4"	10	S	M18x1.5	84203181004
5/16"	10	S	M18x1.5	84203181005
3/8"	10	S	M18x1.5	84203181006
5/16"	12	S	M20x1.5	84203201205
3/8"	12	S	M20x1.5	84203201206
3/8"	14	S	M22x1.5	84203221406
1/2"	14	S	M22x1.5	84203221408
1/2"	16	S	M24x1.5	84203241608
5/8"	20	S	M30x2	84203302010
3/4"	20	S	M30x2	84203302012
3/4"	25	S	M36x2	84203362512
1"	25	S	M36x2	84203362516
1"	30	S	M42x2	84203423016
1"1/4	38	S	M52x2	84203523820

Hembras giratorias rectas rosca Métrica cono 24° /60°

Metric female swivel 24° /60° cone

Femelle Métrique cône 24° /60°

Femmina Metrica sede 24° /60°

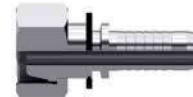

DN	TUBO PIPE	SERIE SERIES	ROSCA THREAD	Referencia Part n°
1/4"	8	L	M14x1.5	84404140804
1/4"	10	L	M16x1.5	84404161004
5/16"	10	L	M16x1.5	84404161005
3/8"	10	L	M16x1.5	84404161006
5/16"	12	L	M18x1.5	84404181205
3/8"	12	L	M18x1.5	84404181206
3/8"	15	L	M22x1.5	84404221506
1/2"	15	L	M22x1.5	84404221508
5/8"	18	L	M26x1.5	84404261810

Conexiones Standard

Standard series
Embouts série standard
Serie Standard

Hembras giratorias DKO 90º Métricas cono 24º

Metric swivel female with o'ring 24º cone (90º Elbow)

Coude 90º femelle Métrique cône 24º avec o'ring

Femmina Metrica 90º sede 24º con o'ring



Hembras giratorias DKO 45º Métricas cono 24º

Metric swivel female with o'ring 24º cone (45º Elbow)

Coude 45º femelle Métrique cône 24º avec o'ring

Femmina Metrica 45º sede 24º con o'ring



DN	TUBO PIPE	ROSCA THREAD	SERIE SERIES	Referencia Part nº
3/16"	6	M12x1,5	L	84305120603
1/4"	6	M12x1,5	L	84305120604
1/4"	8	M14x1,5	L	84305140804
5/16"	8	M14x1,5	L	84305140805
1/4"	10	M16x1,5	L	84305161004
5/16"	10	M16x1,5	L	84305161005
3/8"	10	M16x1,5	L	84305161006
1/4"	12	M18x1,5	L	84305181204
5/16"	12	M18x1,5	L	84305181205
3/8"	12	M18x1,5	L	84305181206
1/2"	12	M18x1,5	L	84305181208
3/8"	15	M22x1,5	L	84305221506
1/2"	15	M22x1,5	L	84305221508
5/8"	15	M22x1,5	L	84305221510
1/2"	18	M26x1,5	L	84305261808
5/8"	18	M26x1,5	L	84305261810
5/8"	22	M30x2	L	84305302210
3/4"	22	M30x2	L	84305302212
3/4"	28	M36x2	L	84305362812
1"	28	M36x2	L	84305362816
1" 1/4	35	M45x2	L	84305453520
1" 1/2	42	M52x2	L	84305524224
1/4"	6	M14x1,5	S	84305140604
1/4"	8	M16x1,5	S	84305160804
5/16"	8	M16x1,5	S	84305160805
1/4"	10	M18x1,5	S	84305181004
5/16"	10	M18x1,5	S	84305181005
3/8"	10	M18x1,5	S	84305181006
1/4"	12	M20x1,5	S	84305201204
5/16"	12	M20x1,5	S	84305201205
3/8"	12	M20x1,5	S	84305201206
1/2"	12	M20x1,5	S	84305201208
3/8"	14	M22x1,5	S	84305221406
1/2"	14	M22x1,5	S	84305221408
3/8"	16	M24x1,5	S	84305241606
1/2"	16	M24x1,5	S	84305241608
3/8"	20	M30x2	S	84305302006
1/2"	20	M30x2	S	84305302008
5/8"	20	M30x2	S	84305302010
3/4"	20	M30x2	S	84305302012
3/4"	25	M36x2	S	84305362512
1"	25	M36x2	S	84305362516
5/8"	30	M42x2	S	84305423010
3/4"	30	M42x2	S	84305423012
1"	30	M42x2	S	84305423016
1" 1/4	38	M52x2	S	84305523820

DN	TUBO PIPE	SERIE SERIES	ROSCA THREAD	Referencia Part nº
3/16"	6	L	M12x1,5	84306120603
1/4"	6	L	M12x1,5	84306120604
1/4"	8	L	M14x1,5	84306140804
5/16"	8	L	M14x1,5	84306140805
1/4"	10	L	M16x1,5	84306181004
5/16"	10	L	M16x1,5	84306181005
3/8"	10	L	M16x1,5	84306181006
1/4"	12	L	M18x1,5	84306181204
5/16"	12	L	M18x1,5	84306181205
3/8"	12	L	M18x1,5	84306181206
1/2"	12	L	M18x1,5	84306181208
3/8"	15	L	M22x1,5	84306221506
1/2"	15	L	M22x1,5	84306221508
5/8"	15	L	M22x1,5	84306221510
1/2"	18	L	M26x1,5	84306261808
5/8"	18	L	M26x1,5	84306261810
5/8"	22	L	M30x2	84306302210
3/4"	22	L	M30x2	84306302212
3/4"	28	L	M36x2	84306362812
1"	28	L	M36x2	84306362816
1" 1/4	35	L	M45x2	84306453520
1" 1/2	42	L	M52x2	84306524224
1/4"	6	S	M14x1,5	84306140604
1/4"	8	S	M16x1,5	84306160804
5/16"	8	S	M16x1,5	84306160805
1/4"	10	S	M18x1,5	84306181004
3/8"	10	S	M18x1,5	84306181006
1/4"	12	S	M20x1,5	84306201204
5/16"	12	S	M20x1,5	84306201205
3/8"	12	S	M20x1,5	84306201206
1/2"	12	S	M20x1,5	84306201208
3/8"	14	S	M22x1,5	84306221406
3/8"	16	S	M24x1,5	84306241606
1/2"	16	S	M24x1,5	84306241608
3/8"	20	S	M30x2	84306302006
1/2"	20	S	M30x2	84306302008
5/8"	20	S	M30x2	84306302010
3/4"	20	S	M30x2	84306302012
3/4"	25	S	M36x2	84306362512
1"	25	S	M36x2	84306362516
3/4"	30	S	M42x2	84306423012
1"	30	S	M42x2	84306423016
1" 1/4	38	S	M52x2	84306523820

Conexiones Standard

Standard series
Embouts série standard
Serie Standard

Hembras giratorias rectas rosca Métrica 24° sin junta tórica

Metric female swivel without o'ring 24° cone

Femelle Métrique cône 24° sans o'ring

Femmina Metrica sede 24° senza o'ring



DN	TUBO PIPE	SERIE SERIES	ROSCA THREAD	Referencia Part n°
1/4"	8	L	M14x1.5	84814140804
5/16"	10	L	M16x1.5	84814161005
3/8"	12	L	M18x1.5	84814181206
1/2"	15	L	M22x1.5	84814221508
5/8"	18	L	M26x1.5	84814261810
3/4"	22	L	M30x2	84814302212
1"	28	L	M36x2	NEW 84814362816

Hembras giratorias 90° Métricas 24° sin junta tórica

Metric swivel female without o'ring 24° cone (90° Elbow)

Coûde 90° femelle Métrique cône 24° sans o'ring

Femmina Metrica 90° sede 24° senza o'ring



DN	TUBO PIPE	SERIE Serie	ROSCA THREAD	Referencia Part n°
1/4"	8	L	M14x1.5	84315140804
5/16"	10	L	M16x1.5	84315161005
3/8"	12	L	M18x1.5	84315181206
1/2"	15	L	M22x1.5	84315221508
5/8"	18	L	M26x1.5	84315261810
3/4"	22	L	M30x2	84315302212

Hembras giratorias 45° Métricas 24° sin junta tórica

Metric swivel female without o'ring 24° cone (45° Elbow)

Coûde 45° femelle Métrique cône 24° sans o'ring

Femmina Metrica 45° sede 24° senza o'ring



DN	TUBO PIPE	SERIE SERIES	ROSCA THREAD	Referencia Part n°
1/4"	8	L	M14x1.5	84316140804
5/16"	10	L	M16x1.5	84316161005
3/8"	12	L	M18x1.5	84316181206
1/2"	15	L	M22x1.5	84316221508
5/8"	18	L	M26x1.5	84316261810
3/4"	22	L	M30x2	84316302212

- Sin junta tórica
- Especial mangueras PTFE
- Altas temperaturas
- Resistencia química

- Without o'ring
- PTFE Hose
- High temperature
- Chemist resistance



Conexiones Standard

Standard series
Embouts série standard
Serie Standard

Espigas lisas rectas Métricas ISO 8434-1 / DIN2353

Metric standpipe for ISO 8434-1 / DIN2353 fittings

Embout lisse droit Métrique ISO 8434-1 / DIN2353

Estremità tubolare per raccordi ISO 8434-1 / DIN2353



DN	TUBO PIPE	Referencia Part n°
3,2 mm	6	841580601
1/8"	6	841580602
3/16"	6	841580603
1/4"	6	841580604
3/16"	8	841580803
1/4"	8	841580804
5/16"	8	841580805
3/8"	8	841580806
1/4"	10	841581004
5/16"	10	841581005
3/8"	10	841581006
1/4"	12	841581204
5/16"	12	841581205
3/8"	12	841581206
1/2"	12	841581208
3/8"	14	841581406
1/2"	14	841581408
3/8"	15	841581506
1/2"	15	841581508
1/2"	16	841581608
1/2"	18	841581808
5/8"	18	841581810
3/4"	18	841581812
1/2"	20	841582008
5/8"	20	841582010
3/4"	20	841582012
5/8"	22	841582210
3/4"	22	841582212
3/4"	25	841582512
1"	25	841582516
1"	28	841582816
1"	30	841583016
1"1/4	35	841583520
1"1/4	38	841583820
1"1/2	38	841583824
1"1/2	42	841584224

Espigas lisas rectas para tubo en pulgadas

Fractional Straight standpipe

Embout lisse tube pouce

Estremità tubolare serie pollici



DN	TUBO PIPE	Referencia Part n°
1/4"	6,4	841590604
3/8"	9,5	841590906
3/8"	12,7	841591206
1/2"	12,7	841591208
5/8"	12,7	841591210
1/2"	15,8	841591508
5/8"	15,8	841591510
5/8"	19,05	841591910
3/4"	19,05	841591912
1"	25,4	841592516

Espigas lisas rectas HEX para tubo en pulgadas TrAle® LOK



Fractional HEX Straight standpipe TrAle® LOK

Embout lisse tube HEX pouce TrAle® LOK

Estremità tubolare HEX serie pollici TrAle® LOK



DN	TUBO PIPE	Referencia Part n°
1/4"	6,4	841690404
3/8"	9,5	841690606
1/2"	12,7	841690808
3/4"	19,05	841691212
1"	25,4	841691616

Espigas lisas 90° Métricas ISO 8434-1 / DIN2353

Metric standpipe ISO 8434-1 / DIN2353 fittings (90° Elbow)

Embout lisse coude 90° Métrique ISO 8434-1 / DIN2353

Estremità tubolare 90° per raccordi ISO 8434-1 / DIN2353



DN	TUBO PIPE	Referencia Part n°
1/8"	6	842580602
3/16"	6	842580603
1/4"	6	842580604
3/16"	8	842580803
1/4"	8	842580804
5/16"	8	842580805
1/4"	10	842581004
5/16"	10	842581005
3/8"	10	842581006
1/4"	12	842581204
5/16"	12	842581205
3/8"	12	842581206
1/2"	12	842581208
3/8"	14	842581406
1/2"	14	842581408
3/8"	15	842581506
1/2"	15	842581508
1/2"	16	842581608
1/2"	18	842581808
5/8"	18	842581810
5/8"	20	842582010
3/4"	20	842582012
5/8"	22	842582210
3/4"	22	842582212
3/4"	25	842582512
1"	28	842582816
1"	30	842583016

Espigas lisas 90° para tubo en pulgadas

Fractional standpipe (90° Elbow)

Embout lisse coude 90° tube pouce

Estremità tubolare 90° serie pollici



DN	TUBO PIPE	Referencia Part n°
1/4"	6,4	842590604
3/8"	9,5	842590906
1/2"	12,7	842591208

Conexiones Standard

Standard series
Embouts série standard
Serie Standard

Espigas lisas 45° Métricas ISO 8434-1 / DIN2353

Metric standpipe ISO 8434-1 / DIN2353 fittings
(45° Elbow)

Embout lisse coude 45° ISO 8434-1 / DIN2353

Estremità tubolare 45° per raccordi ISO 8434-1 / DIN2353



DN	TUBO PIPE	Referencia Part n°
1/8"	6	843580602
3/16"	6	843580603
1/4"	6	843580604
3/16"	8	843580803
1/4"	8	843580804
5/16"	8	843580805*
1/4"	10	843581004
5/16"	10	843581005
3/8"	10	843581006
1/4"	12	843581204
5/16"	12	843581205
3/8"	12	843581206
1/2"	12	843581208
3/8"	14	843581406
1/2"	14	843581408
3/8"	15	843581506
1/2"	15	843581508
1/2"	16	843581608
1/2"	18	843581808
5/8"	18	843581810
5/8"	20	843582010
1/2"	20	843582012
5/8"	22	843582210
3/4"	22	843582212
3/4"	25	843582512
1"	28	843582816
1"	30	843583016

* Hasta fin de existencias / Until end of stock / Jusqu'à la fin du stock / Fino ad esaurim

Espigas lisas 45° para tubo en pulgadas

Fractional Standpipe for inch tube (45° Elbow)

Embout lisse coude 45° tube pouce

Estremità tubolare 45° serie pollici



DN	TUBO PIPE	Referencia Part n°
1/4"	6,4	843590604
3/8"	9,5	843590906
1/2"	12,7	843591208

Espigas de prensar dobles

Double crimp standpipe

Embout double jonction

Giunzione tubo-tubo



DN	Referencia Part n°
1/4"	843000404
5/16"	843000505
3/8"	843000606
1/2"	843000808
3/4"	843001212
1"	843001616
1"1/4"	843002020
1" 1/2"	843002424
2"	843003232

Espigas soldables

Welding standpipes

Embout lisse à souder

Inserti a saldare



DN	Referencia Part n°
1/8"	840000200*
3/16"	840000300
1/4"	840000400
5/16"	840000500
3/8"	840000600
1/2"	840000800
5/8"	840001000
3/4"	840001200
1"	840001600
1"1/4"	840002000
1"1/2"	840002400
2"	840003200
2"1/2"	840004000

* Hasta fin de existencias / Until end of stock / Jusqu'à la fin du stock / Fino as esaur

Espigas para Hidrolavadoras

Standpipes for hidrowashing machines

Embouts lisses pour hydrolavage

Inserti per idropulitrici



TUBO PIPE	ROSCA THREAD	Referencia Part n°
5/16"	M 22x1,5	8305005
3/8"	M 22x1,5	8305006

Tuercas para terminales hidrolavadoras inox

Hexagonal nuts for hydrowashing machines

Écrous pour hidronettoyages

Dado per idropulitrici



ROSCA THREAD	Referencia Part n°
M22x1,5	KZTHAP22

Conexiones Standard

Standard series
Embouts série standard
Serie Standard

Orientables BSP

Banjo BSP

Banjo droit gaz BSP

Raccordo ad occhio BSP



DN	∅	Referencia Part n°
1/4"	1/4"	841110404
1/4"	3/8"	841110604
5/16"	3/8"	841110605
3/8"	3/8"	841110606
1/2"	3/8"	841110608
3/8"	1/2"	841110806
1/2"	1/2"	841110808
3/4"	3/4"	841111212
1"	1"	841111616

Tornillo orientable simple BSP

BSP Bolt for banjo

Vis creuse simple pour banjo gaz

Bullone forato BSP



ROSCA THREAD	Referencia Part n°	€
1/8" BSP	Z109002	*
1/4" BSP	Z109004	*
3/8" BSP	Z109006	*
1/2" BSP	Z109008	*
3/4" BSP	Z109012	*
1" BSP	Z109016	*

*Ver precios en p.176 (ADAPTADORES BSP) / *See prices in p.176 (BSP ADAPTORS) / *Prix à la p.176 (ADAPTEURS BSP) / *Vedere prezzi p.176 (ADATTATORI BSP)

Orientables Métricos

Banjo Metric

Banjo droit Métrique

Raccordo ad occhio Metrico



DN	∅	Referencia Part n°
3/16"	M10x1	841161003
1/4"	M10x1	841161004
5/16"	M10x1	NEW 841161005
1/4"	M12x1,5	841161204
1/4"	M14x1,5	841161404
3/8"	M14x1,5	841161406
5/16"	M16x1,5	841161605
3/8"	M16x1,5	841161606
3/8"	M18x1,5	841161806
1/2"	M18x1,5	841161808
1/2"	M20x1,5	841162008
1/2"	M22x1,5	841162208
3/4"	M26x1,5	841162612

Tornillo orientable simple Métrico

Metric bolt for banjo

Vis creuse simple for banjo Métrique

Bullone forato Metrico



ROSCA THREAD	Referencia Part n°	€
M12X1,5	Z109212	*
M14X1,5	Z109214	*
M16X1,5	Z109216	*
M18X1,5	Z109218	*
M22X1,5	Z109222	*
M26X1,5	Z109226	*
M30X2	Z109230	*

*Ver precios en p.176 (ADAPTADORES BSP) / *See prices in p.176 (BSP ADAPTORS) / *Prix à la p.176 (ADAPTEURS BSP) / *Vedere prezzi p.176 (ADATTATORI BSP)

Conexiones Standard

Standard series
Embouts série standard
Serie Standard

Bridas rectas SAE 3000 PSI

3000 PSI SAE Straight Flange / Code 61

Bride SAE droite série 3000 PSI

Flangia diritta SAE 3000



DN	Ø	Referencia Part n°
1/2"	30,2	841820808
1/2"	38,1	841821208
5/8"	38,1	841821210
3/4"	38,1	841821212
3/4"	44,5	841821612
1"	44,5	841821616
1"	50,8	841822016
1"1/4	50,8	841822020
1"1/4	60,3	841822420
1"1/2	60,3	841822424
1"1/2	71,4	841823224
2"	71,4	841823232
2" 1/2	84,1	841824040
3"	101,6	841824848

Bridas 90° SAE 3000 PSI

3000 PSI SAE Flange (90° Elbow) / Code 61

Bride SAE coude 90° série 3000 PSI

Flangia 90° SAE 3000



DN	Ø	Referencia Part n°
1/2"	30,2	841830808
1/2"	38,1	841831208
5/8"	38,1	841831210
3/4"	38,1	841831212
3/4"	44,5	841831612
1"	44,5	841831616
1"	50,8	841832016
1"1/4	50,8	841832020
1"1/4	60,3	841832420
1"1/2	60,3	841832424
1"1/2	71,4	841833224
2"	71,4	841833232

Bridas 45° SAE 3000 PSI

3000 PSI SAE Flange (45° Elbow) / Code 61

Bride SAE coude 45° série 3000 PSI

Flangia 45° SAE 3000



DN	Ø	Referencia Part n°
1/2"	30,2	841840808
1/2"	38,1	841841208
5/8"	38,1	841841210
3/4"	38,1	841841212
3/4"	44,5	841841612
1"	44,5	841841616
1"	50,8	841842016
1"1/4	50,8	841842020
1"1/4	60,3	841842420
1"1/2	60,3	841842424
1"1/2	71,4	841843224
2"	71,4	841843232

Bridas rectas SAE 6000 PSI

6000 PSI SAE Straight Flange / Code 62

Bride SAE droite série 6000 PSI

Flangia diritta SAE 6000



DN	Ø	Referencia Part n°
1/2"	31,8	842820808
1/2"	41,3	842821208
5/8"	41,3	842821210
3/4"	41,3	842821212
3/4"	47,6	842821612
1"	47,6	842821616
1"	54	842822016
1"1/4	54	842822020
1"1/4	63,5	842822420
1"1/2	63,5	842822424
1"1/2	79,4	842823224
2"	79,4	842823232

Bridas 90° SAE 6000 PSI

6000 PSI SAE Flange (90° Elbow) / Code 62

Bride SAE coude 90° série 6000 PSI

Flangia 90° SAE 6000



DN	Ø	Referencia Part n°
1/2"	31,8	842830808
1/2"	41,3	842831208
5/8"	41,3	842831210
3/4"	41,3	842831212
3/4"	47,6	842831612
1"	47,6	842831616
1"	54	842832016
1"1/4	54	842832020
1"1/4	63,5	842832420
1"1/2	63,5	842832424
1"1/2	79,4	842833224
2"	79,4	842833232

Bridas 45° SAE 6000 PSI

6000 PSI SAE Flange (45° Elbow) / Code 62

Bride SAE coude 45° série 6000 PSI

Flangia 45° SAE 6000



DN	Ø	Referencia Part n°
1/2"	31,8	842840808
1/2"	41,3	842841208
5/8"	41,3	842841210
3/4"	41,3	842841212
3/4"	47,6	842841612
1"	47,6	842841616
1"	54	842842016
1"1/4	54	842842020
1"1/4	63,5	842842420
1"1/2	63,5	842842424
1"1/2	79,4	842843224
2"	79,4	842843232

Conexiones Standard

Standard series
Embouts série standard
Serie Standard

Brida partida pasante

SAE Split flange

Demi-bride de fixation

Semiflangia SAE



SERIE SERIES	Ø INT. Ø INNER	TAMAÑO SIZE	Referencia Part n°
3000 PSI	30,2	1/2"	ZBBP308302
3000 PSI	38,1	3/4"	ZBBP312381
3000 PSI	44,5	1"	ZBBP316445
3000 PSI	50,8	1"1/4	ZBBP320508
3000 PSI	60,3	1"1/2	ZBBP324603
3000 PSI	71,4	2"	ZBBP332714
3000 PSI	84,1	2" 1/2	ZBBP340841
3000 PSI	102,4	3"	ZBBP3481024
3000 PSI	127	4"	ZBBP364127
6000 PSI	31,8	1/2"	ZBBP608318
6000 PSI	41,3	3/4"	ZBBP612413
6000 PSI	47,6	1"	ZBBP616476
6000 PSI	54	1"1/4	ZBBP620540
6000 PSI	63,5	1"1/2	ZBBP624635
6000 PSI	79,4	2"	ZBBP632794

€/par / €/pair / €/paire / €/coppia

Brida entera pasante

SAE Flange

Bride de fixation monobloc

Flangia monoblocco SAE



SERIE SERIES	Ø INT. Ø INNER	TAMAÑO SIZE	Referencia Part n°
3000 PSI	30,2	1/2"	ZBBE308302
3000 PSI	38,1	3/4"	ZBBE312381
3000 PSI	44,5	1"	ZBBE316445
3000 PSI	50,8	1"1/4	ZBBE320508
3000 PSI	60,3	1"1/2	ZBBE324603
3000 PSI	71,4	2"	ZBBE332714
3000 PSI	41	2" 1/2	ZBBE340841
3000 PSI	102,4	3"	ZBBE3481024
3000 PSI	127	4"	ZBBE364127
6000 PSI	31,8	1/2"	ZBBE608318
6000 PSI	41,3	3/4"	ZBBE612413
6000 PSI	47,6	1"	ZBBE616476
6000 PSI	54	1"1/4	ZBBE620540
6000 PSI	63,5	1"1/2	ZBBE624635
6000 PSI	79,4	2"	ZBBE632794

Tornillos para bridas SAE

Screws for SAE flanges

Vis pour brides SAE

Vite per flangia SAE



ROSCA THREAD	TAMAÑO SIZE	Referencia Part n°	€
M8X30	3000-6000 PSI 1/2"	ZTB8X30	*
M10X35	3000 PSI 3/4"-1"	ZTB10X35	*
M10X40	3000 PSI 1" 1/4 - 6000 PSI 3/4"	ZTB10X40	*
M12X45	3000 PSI 1"1/2-2"-2"1/2-6000 PSI 1"	ZTB12X45	*
M14X45	6000 PSI 1"1/4	ZTB14X45	*
M16X50	3000 PSI 3"-3"1/2"-4"- 6000 PSI 1" 1/2	ZTB16X50	*
M20X70	6000 PSI 2"	ZTB20X70	*

*Ver precios en p.154 / *See prices p.154 / *Voir prix p.154 / *Vedere prezzi p. 154

Contrabrida roscada

SAE counter-flange

Contre-bride passage total

Controflangia SAE



SERIE SERIES	Ø INT. Ø INNER	TAMAÑO SIZE	Referencia Part n°	€
3000 PSI	30,2	1/2"	ZBCE308302	*
3000 PSI	38,1	3/4"	ZBCE312381	*
3000 PSI	44,5	1"	ZBCE316445	*
3000 PSI	50,8	1"1/4	ZBCE320508	*
3000 PSI	60,3	1"1/2	ZBCE324603	*
3000 PSI	71,4	2"	ZBCE332714	*
6000 PSI	31,8	1/2"	ZBCE608318	*
6000 PSI	41,3	3/4"	ZBCE612413	*
6000 PSI	47,6	1"	ZBCE616476	*
6000 PSI	54	1"1/4	ZBCE620540	*
6000 PSI	63,5	1"1/2	ZBCE624635	*
6000 PSI	79,4	2"	ZBCE632794	*

Juntas para bridas SAE 3000/6000 PSI

Seals for 3000/6000 PSI flange

Joints pour bride série 3000/6000

Guarnizioni per flangia SAE 3000/6000 PSI



TAMAÑO SIZE	Ø INT. Ø INNER	Ø EXT. Ø OUTER	Referencia Part n°	€
1/2"	17,02	25,40	JBR08	*
3/4"	23,36	31,72	JBR12	*
1"	31,24	39,62	JBR16	*
1"1/4	36,07	44,45	JBR20	*
1"1/2	45,34	53,98	JBR24	*
2"	54,86	63,50	JBR32	*

*Ver precios en Conducciones Hidráulicas y Neumáticas / *See prices in Hydraulic and Pneumatic Connectors' Catalogue / *Voir prix dans le Catalogue Connectique Hydraulique et Pneumatique / *Vedere prezzi nel listino Conduzioni Idrauliche e Pneumatiche

Juntas tóricas para bridas SAE 3000/6000 PSI

O-rings for 3000/6000 PSI flange

O-rings pour bride série 3000/6000 PSI

O-rings per flangia SAE 3000/6000 PSI



TAMAÑO SIZE	Ø INT. Ø INNER	Referencia Part n°	€
1/2"	18,64	18.64X3.53	*
3/4"	24,99	24.99X3.53	*
1"	32,92	32.92X3.53	*
1"1/4	37,70	37.70X3.53	*
1"1/2	47,22	47.22X3.53	*
2"	56,74	56.74X3.53	*

*Ver precios en Conducciones Hidráulicas y Neumáticas / *See prices in Hydraulic and Pneumatic Connectors' Catalogue / *Voir prix dans le Catalogue Connectique Hydraulique et Pneumatique / *Vedere prezzi nel listino Conduzioni Idrauliche e Pneumatiche

Conexiones Standard

Standard series
Emboutis série standard
Serie Standard

Hembras giratorias rectas ORFS doble hexagonal

Double hexagonal ORFS Swivel female straight

Femelle droite ORFS double hexagonal

Femmina diritta ORFS doppio esagono



DN	ROSCA THREAD	Referencia Part n°
1/4"	9/16"-18h	849010904
1/4"	11/16"-16h	849011104
5/16"	11/16"-16h	849011105
3/8"	11/16"-16h	849011106
3/8"	13/16"-16h	849011306
1/2"	13/16"-16h	849011308
1/2"	1"-14h	849011608
5/8"	1"-14h	849011610
1/2"	1"3/16-12h	849011908
5/8"	1"3/16-12h	849011910
3/4"	1"3/16-12h	849011912
3/4"	1"7/16-12h	849012312
1"	1"7/16-12h	849012316
1"1/4	1" 11/16-12h	849012720
1"1/2	2"-12h	849013224
2"	2"-12h	849013232

Machos ORFS

ORFS Male

Mâle ORFS

Maschio ORFS



DN	ROSCA THREAD	Referencia Part n°
1/4"	9/16"-18h	849120904
5/16"	11/16"-16h	849121105
3/8"	11/16"-16h	849121106
1/2"	13/16"-16h	849121308
5/8"	1"-14h	849121610
3/4"	1"3/16-12h	849121912
1"	1"7/16-12h	849122316
1"1/4	1" 11/16-12h	849122720
1"1/2	2"-12h	849123224

Hembras giratorias 90° ORFS

ORFS Swivel female (90° Elbow)

Coûde 90° femelle ORFS

Femmina 90° ORFS



DN	ROSCA THREAD	Referencia Part n°
1/4"	9/16"-18h	849070904
1/4"	11/16"-16h	849071104
5/16"	11/16"-16h	849071105
3/8"	11/16"-16h	849071106
3/8"	13/16"-16h	849071306
1/2"	13/16"-16h	849071308
1/2"	1"-14h	849071608
5/8"	1"-14h	849071610
5/8"	1"3/16-12h	849071910
3/4"	1"3/16-12h	849071912
3/4"	1"7/16-12h	849072312
1"	1"7/16-12h	849072316
1"1/4	1" 11/16-12h	849072720
1"1/2	2"-12h	849073224

Hembras giratorias 45° ORFS

ORFS Swivel female (45° Elbow)

Coûde 45° femelle ORFS

Femmina 45° ORFS



DN	ROSCA THREAD	Referencia Part n°
1/4"	9/16"-18h	849080904
1/4"	11/16"-16h	849081104
5/16"	11/16"-16h	849081105
3/8"	11/16"-16h	849081106
3/8"	13/16"-16h	849081306
1/2"	13/16"-16h	849081308
1/2"	1"-14h	849081608
5/8"	1"-14h	849081610
5/8"	1"3/16-12h	849081910
3/4"	1"3/16-12h	849081912
3/4"	1"7/16-12h	849082312
1"	1"7/16-12h	849082316
1"1/4	1" 11/16-12h	849082720
1"1/2	2"-12h	849083224

Macho O'Ring Boss

O'Ring Boss Male

Mâle O'Ring Boss

Maschio O'Ring Boss

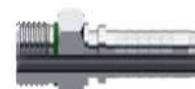

DN	ROSCA THREAD	Referencia Part n°
1/4"	7/16"-20h UNF	847120604
3/8"	9/16"-18h UNF	847121006
1/2"	3/4"-16h UNF	847121208
5/8"	7/8"-14h UNF	847121610
3/4"	1"1/16-12h UN	847122012
1"	1"5/16-12h UN	847122516

Conexiones Serie BW+ R13/R15 No Pelar

Fittings BW+ Series R13/R15 No Skive
Embouts R13/R15 Série BW+ Sans denuder
Raccordi R13/R15 Serie BW+ senza spellatura

Casquillos R13/R15 para serie BW/BW+

Ferrules R13/R15 for fittings BW/BW+ series

Jupes R13/R15 pour embouts série BW/BW+

Boccole a pressione per R13/R15 per raccordi serie BW/BW+



DN	Referencia Part n°	
1"1/4	ZAC690102000	
1"1/2	ZAC690102400	1
2"	ZAC690103200	1

Hembras gir. rectas BSP cono 60° doble hexagonal c/

BSP Swivel female 60° cone double hexagonal with o'ring

Femelle tournante gaz cyl BSP 60° double hexagonale avec o'ring

Femmina diritta BSP sede 60° doppia esagono con o'ring



DN	ROSCA THREAD	Referencia Part n°
1"1/4	1"1/4 BSP	Z664102020
1"1/2	1"1/2 BSP	Z664102424
2"	2" BSP	Z664103232

Hasta fin de existencias / Until end of stock / Jusqu'à la fin du stock / Fino ad esaurimento

Hembras giratorias 90° BSP cono 60° con junta

BSP Swivel female 60° cone with o'ring (90° Elbow)

Coude 90° femelle tournante gaz cyl BSP 60° avec joint

Femmina a 90° BSP sede 60° con o'ring



DN	ROSCA THREAD	Referencia Part n°
1"1/4	1"1/4 BSP	Z661172020

Hasta fin de existencias / Until end of stock / Jusqu'à la fin du stock / Fino ad esaurimento

Hembras giratorias 45° BSP cono 60° con junta

BSP Swivel female 60° cone with o'ring (45° Elbow)

Hembras giratorias 45° BSP cono 60° avec o'ring

Femmina a 45° BSP sede 60° con o'ring



DN	ROSCA THREAD	Referencia Part n°
1"1/4	1"1/4 BSP	Z661182020

Hasta fin de existencias / Until end of stock / Jusqu'à la fin du stock / Fino ad esaurimento

Machos cilíndricos BSP 60°

BSP Male 60° cone

Mâle gaz cylindrique BSP 60°

Maschio BSP cilindrico sede 60°



DN	ROSCA THREAD	Referencia Part n°
1"1/4	1"1/4 BSP	Z661122020
1"1/2	1"1/2 BSP	Z661122424
2"	2" BSP	Z661123232

Hembras gir rectas BSP (60°) doble hex c/J tca eng.



Double hexagonal BSP Swivel female cone 60° with o'ring wire nut

Femelle BSP cône 60° double hexagonal avec joint torique écrou à douille

Femmina diritta BSP sede 60° doppio esagono con o'ring dado spinato



DN	ROSCA THREAD	Referencia Part n°
1"1/4	1"1/4 BSP	Z665102020
1"1/2	1"1/2 BSP	Z665102424
2"	2" BSP	Z665103232

Hembras gir 90° BSP (60°) c/j tca engargolada



BSP 60° cone Swivel female (90° Elbow) with o'ring wire nut

Coude 90° femelle gaz cylindrique BSP 60° avec joint torique écrou à jonc

Femmina 90° BSP sede 60° con o'ring dado spinato



DN	ROSCA THREAD	Referencia Part n°
1"1/4 BSP	1"1/4 BSP	Z665172020
1"1/2 BSP	1"1/2 BSP	Z665172424
2" BSP	2" BSP	Z665173232

Hembras gir 45° BSP (60°) c/j tca engargolada



BSP 60° cone Swivel female (45° Elbow) with o'ring wire nut

Coude 45° femelle gaz cylindrique BSP 60° avec joint torique écrou à jonc

Femmina 45° BSP sede 60° con o'ring dado spinato



DN	ROSCA THREAD	Referencia Part n°
1"1/4 BSP	1"1/4	Z665182020
1"1/2 BSP	1"1/2	Z665182424
2" BSP	2"	Z665183232

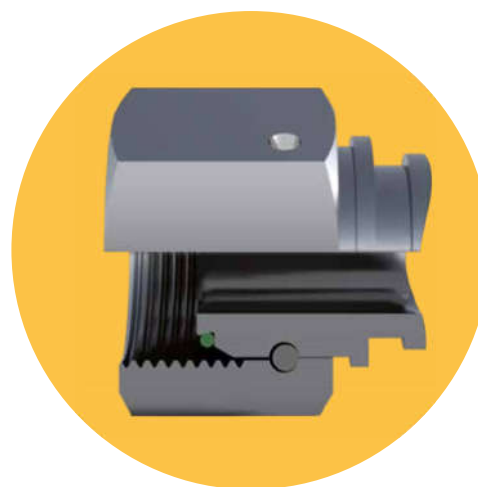

Conexiones Serie BW+ R13/R15 No Pelar

Fittings BW+ Series R13/R15 No Skive
 Embouts R13/R15 Série BW+ Sans denuder
 Raccordi R13/R15 Serie BW+ senza spellatura

Hembras gir rectas NPSM (60°) doble hexagonal con junta

Double hexagonal NPSM female 60° cone with o'ring

Femelle NPSM cône 60° double hexagonal avec joint torique

Femmina diritta NPSM sede 60° doppio esagono con o'ring



DN	ROSCA THREAD	Referencia Part n°
1"1/4	1"1/4 NPSM	Z664612020
1"1/2	1"1/2 NPSM	Z664612424
2"	2" NPSM	Z664613232

Machos cónicos NPT

NPT Male pipe straight

Mâle conique NPT

Maschio conico NPT



DN	ROSCA THREAD	Referencia Part n°
1"1/4	1"1/4 NPT	Z661612020
1"1/2	1"1/2 NPT	Z661612424
2"	2" NPT	Z661613232

Hembras giratorias rectas JIC 37° doble hexagonal

Double Hexagonal JIC 37° Swivel female

Femelle JIC 37° double hexagonal

Femmina diritta JIC 37° doppio esagono



DN	ROSCA THREAD	Referencia Part n°
1"1/4	1"5/8 12h UN	Z662422620
1"1/2	1"7/8 12h UN	Z662423024
2"	2"1/2 12h UN	Z662424032

Hembras giratorias 90° JIC 37°

JIC 37° Swivel female (90° Elbow)

Coûde 90° femelle JIC 37°

Femmina gir. 90° JIC 37°



DN	ROSCA THREAD	Referencia Part n°
1"1/4	1"5/8 12h UN	Z661382620
1"1/2	1"7/8 12h UN	Z661383024
2"	2"1/2 12h UN	Z661384032

Hembras giratorias 45° JIC 37°

JIC 37° Swivel female (45° Elbow)

Coûde 45° femelle JIC 37°

Femmina gir. 45° JIC 37°



DN	ROSCA THREAD	Referencia Part n°
1"1/4	1"5/8 12h UN	Z661392620
1"1/2	1"7/8 12h UN	Z661393024
2"	2"1/2 12h UN	Z661394032

Machos JIC 37° con junta

JIC 37° male with o'ring

Mâle JIC 37° avec joint torique

Maschio JIC 37° con o'ring



DN	ROSCA THREAD	Referencia Part n°
1"1/4	1"5/8 12h UNF	Z661412620
1"1/2	1"7/8 12h UNF	Z661413024
2"	2"1/2 12h UNF	Z661414032

Conexiones Serie BW+ R13/R15 No Pelar

Fittings BW+ Series R13/R15 No Skive
Embouts R13/R15 Série BW+ Sans denuder
Raccordi R13/R15 Serie BW+ senza spellatura

Hembras giratorias rectas ORFS doble hexagonal

ORFS Swivel female straight

Femelle droite ORFS

Femmina diritta ORFS



DN	ROSCA THREAD	Referencia Part n°
1" 1/4	1"11/16-12h	Z669012720
1" 1/2	2"-12h	Z669013224

Hembras giratorias 90° ORFS asiento plano

ORFS Swivel female (90° Elbow)

Coude 90° femelle ORFS

Femmina 90° ORFS



DN	ROSCA THREAD	Referencia Part n°
1" 1/4	1"11/16-12h	Z669072720
1" 1/2	2"-12h	Z669073224

Hembras giratorias 45° ORFS asiento plano

ORFS Swivel female (45° Elbow)

Coude 45° femelle ORFS

Femmina 45° ORFS



DN	ROSCA THREAD	Referencia Part n°
1" 1/4	1"11/16-12h	Z669082720*
1" 1/2	2"-12h	Z669083224

Machos ORFS

ORFS Male

Mâle ORFS

Maschio ORFS



DN	ROSCA THREAD	Referencia Part n°	€
1"1/4	1"11/16-12h	Z669122720	267,40
1"1/2	2"-12h	Z669123224	393,54

Hembras giratorias Métricas cono 24° con junta tórica

Metric swivel female 24° seat with o'ring

Femelle Métrique 24° avec o'ring

Femmina Metrica sede 24° con o'ring

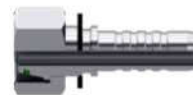

DN	TUBO PIPE	SERIE SERIES	ROSCA THREAD	Referencia Part n°
1"1/4	38	S	M52X2	Z66204523820
1"1/2	38	S	M52X2	Z66204523824

Hembras giratorias 90° Métricas cono 24° con junta tóri

Metric swivel female 24° seat with o'ring (90° Elbow)

Coude 90° femelle Métrique 24° avec o'ring

Femmina Metrica 90° sede 24° con o'ring



DN	TUBO PIPE	SERIE SERIES	ROSCA THREAD	Referencia Part n°
1"1/4	38	S	M52X2	Z66205523820

Hembras giratorias 45° Métricas cono 24° con junta tóri

Metric swivel female 24° seat with o'ring (45° Elbow)

Coude 45° femelle Métrique 24° avec o'ring

Femmina Metrica 45° sede 24°



DN	TUBO PIPE	SERIE SERIES	ROSCA THREAD	Referencia Part n°
1"1/4	38	S	M52X2	Z66206523820

Machos hijos Métricos cono 24°

Metric male stud 24° cone

Mâle Métrique cône 24°

Maschio Metrico sede 24° con o'ring



DN	TUBO PIPE	SERIE SERIES	ROSCA THREAD	Referencia Part n°	€
1"1/4	38	S	M52x2	Z66203523820	135,30

Conexiones Serie BW+ R13/R15 No Pelar

Fittings BW+ Series R13/R15 No Skive
 Embouts R13/R15 Série BW+ Sans denuder
 Raccordi R13/R15 Serie BW+ senza spellatura

Bridas recta SAE 6000 PSI

6000 PSI SAE Straight Flange / Code 62

Bride SAE droite série 6000 PSI

Flangia diritta SAE 6000



DN	∅	Referencia Part n°
1"1/4	54	Z662822020
1"1/4	63,5	Z662822420
1"1/2	63,5	Z662822424
2"	54	Z662822032
2"	79,4	Z662823232

Bridas a 90° SAE 6000 PSI

6000 PSI SAE Flange (90° Elbow) / Code 62

Bride SAE coude 90° série 6000 PSI

Flangia 90° SAE 6000



DN	∅	Referencia Part n°
1"1/4	54	Z662832020
1"1/4	63,5	Z662832420 <small>NEW</small>
1"1/2	63,5	Z662832424
2"	79,4	Z662833232

Bridas a 45° SAE 6000 PSI

6000 PSI SAE Flange (45° Elbow) / Code 62

Bride SAE coude 45° série 6000 PSI

Flangia 45° SAE 6000



DN	∅	Referencia Part n°
1"1/4	54	Z662842020
1"1/2	63,5	Z662842424
2"	79,4	Z662843232

Conexiones Interlock

Interlock series
Embouts Interlock
Serie Interlock

Casquillos Interlock 4SH

Ferrules DIN 20023 - 4SH Interlock

Jupes à sertir DIN 20023 - 4SH Interlock

Boccola Interlock 4SH



DN	MANGUERA HOSE	Referencia Part n°
3/4"	4SH / R13 / R15	ZA610101200
1"	4SH / R13 / R15	ZA610101600
1"1/4	4SH	ZA610102000
1"1/2	4SH	ZA610102400
2"	4SH	ZA610103200

Casquillos Interlock R13/R15

Ferrules SAE 100 R13/R15 Interlock

Jupes à sertir R13/R15 Interlock

Boccola Interlock R13/R15



DN	Referencia Part n°
1" 1/4	Z610102000
1"1/2	Z610102400
2"	Z610103200

Para 3/4" y 1" son los mismos casquillos que en 4SH / 3/4" and 1" are the same ferrule
sont les mêmes jupes que pour 4SH / Per 3/4" e 1" si utilizza la boccola 4SH

Hembras giratoria 90° BSP cono 60° con junta

BSP 60° cone Swivel female Interlock (90° Elbow)
with o'ring

Coude 90° femelle gaz cylindrique BSP 60°
Interlock avec joint torique

Femmina 90° BSP sede 60° Interlock con o'ring



DN	ROSCA THREAD	Referencia Part n°
1"1/4	1"1/4 BSP	Z641072020
2"	2" BSP	Z641073232

Hasta fin de existencias / Until end of stock / Jusqu'à la fin du stock / Fino ad esaurimen

Hembras giratoria 45° BSP cono 60° con junta

BSP 60° cone Swivel female Interlock (45° Elbow)
with o'ring

Coude 45° femelle gaz cylindrique BSP 60°
Interlock avec joint torique

Femmina 45° BSP sede 60° Interlock con o'ring



DN	ROSCA THREAD	Referencia Part n°
3/4"	3/4" BSP	Z641081212
2"	2" BSP	Z641083232

Hasta fin de existencias / Until end of stock / Jusqu'à la fin du stock / Fino ad esaurimen

Machos cilíndricos BSP cono 60°

BSP 60° Male cone

Mâle gaz cylindrique BSP 60° Interlock

Maschio BSP cilindrico sede 60° Interlock



DN	ROSCA THREAD	Referencia Part n°
3/4"	3/4" BSP	Z641121212
1"	1" BSP	Z641121616
1"1/4	1"1/4 BSP	Z641122020
1"1/2	1"1/2 BSP	Z641122424
2"	2" BSP	Z641123232

Machos cónicos NPT

NPT Male pipe straight Interlock

Mâle conique NPT Interlock

Maschio conico NPT Interlock



DN	ROSCA THREAD	Referencia Part n°
3/4"	3/4" NPT	Z641611212
1"	1" NPT	Z641611616
1"1/4	1"1/4 NPT	Z641612020
1"1/2	1"1/2 NPT	Z641612424
2"	2" NPT	Z641613232

Conexiones Interlock

Interlock series
Emboutis Interlock
Serie Interlock

Hembras gir rectas BSP (60°) con junta (tca engargolada)

BSP 60° cone Swivel female Interlock with o'ring wire nut

Femelle droite gaz cylindrique BSP 60° Interlock avec joint torique écrou à jonc

Femmina diritta BSP sede 60° Interlock con o'ring dado spinato



DN	ROSCA THREAD	Referencia Part n°
3/4"	3/4" BSP	Z645001212
1"	1" BSP	Z645001616
1"1/4	1"1/4 BSP	Z645002020
1"1/2	1"1/2 BSP	Z645002424
2"	2" BSP	Z645003232

Hembras gir 90° BSP (60°) con junta (tca engargolada)

BSP 60° cone Swivel female Interlock (90° Elbow) with o'ring wire nut

Coude 90° femelle gaz cylindrique BSP 60° Interlock avec joint torique écrou à jonc

Femmina 90° BSP sede 60° Interlock con o'ring dado spinato



DN	ROSCA THREAD	Referencia Part n°
3/4"	3/4" BSP	Z645071212
1"	1" BSP	Z645071616
1"1/4	1"1/4 BSP	Z645072020
1"1/2	1"1/2 BSP	Z645072424
2"	2" BSP	Z645073232

Hembras gir 45° BSP (60°) con junta (tca engargolada)

BSP 60° cone Swivel female Interlock (45° Elbow) with o'ring wire nut

Coude 45° femelle gaz cylindrique BSP 60° Interlock avec joint torique écrou à jonc

Femmina 45° BSP sede 60° Interlock con o'ring dado spinato



DN	ROSCA THREAD	Referencia Part n°
3/4"	3/4" BSP	Z645081212
1"	1" BSP	Z645081616
1"1/4	1"1/4 BSP	Z645082020
1"1/2	1"1/2 BSP	Z645082424
2"	2" BSP	Z645083232

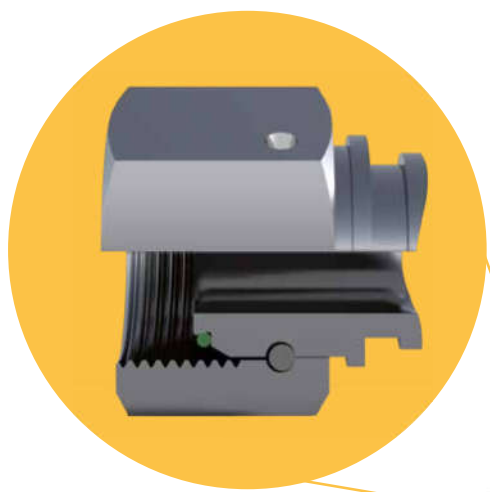

Conexiones Interlock

Interlock series
Embouts Interlock
Serie Interlock

Hembras giratorias JIC 37° doble hexagonal Interlock

Double hexagonal JIC 37° Swivel female

Femelle JIC 37° double hexagonal

Femmina diritta JIC 37° doppio esagono Interlock



DN	ROSCA THREAD	Referencia Part n°
3/4"	1"1/16 12h UN	Z642421712
1"	1"5/16 12h UN	Z642422116
1"1/4	1"5/8 12h UN	Z642422620
1"1/2	1"7/8 12h UN	Z642423024
2"	2"1/2 12h UN	Z642424032

Hembras giratorias rectas JIC 37° Interlock

JIC 37° Swivel female Interlock

Femelle tourn.droite JIC 37° Interlock

Femmina diritta JIC 37° Interlock



DN	ROSCA THREAD	Referencia Part n°
3/4"	1"1/16 12h UN	Z641421712
1"	1"5/16 12h UN	Z641422116
1"1/4	1"5/8 12h UN	Z641422620
1"1/4	1"7/8 12h UN	Z641423020
1"1/2	1"7/8 12h UN	Z641423024
2"	2"1/2 12h UN	Z641424032

Machos JIC 37° Interlock

JIC 37° male Interlock

Mâle JIC 37° Interlock

Maschio JIC 37° Interlock



DN	ROSCA THREAD	Referencia Part n°
3/4"	1"1/16 12h UN	Z641401712
1"	1"5/16 12h UN	Z641402116
1"1/4	1"5/8 12h UN	Z641402620
1"1/2	1"7/8 12h UN	Z641403024
2"	2"1/2 12h UN	Z641404032

Hembras giratorias 90° JIC 37° Interlock

JIC 37° Swivel female Interlock (90° Elbow)

Coude 90° femelle tournante JIC 37° Interlock

Femmina 90° JIC 37° Interlock



DN	ROSCA THREAD	Referencia Part n°
3/4"	1"1/16 12h UN	Z641381712
1"	1"5/16 12h UN	Z641382116
1"1/4	1"5/8 12h UN	Z641382620
1"1/2	1"7/8 12h UN	Z641383024
2"	2"1/2 12h UN	Z641384032

Hembras giratorias 45° JIC 37° Interlock

JIC 37° Swivel female Interlock (45° Elbow)

Coude 45° femelle tournante JIC 37° Interlock

Femmina 45° JIC 37° Interlock



DN	ROSCA THREAD	Referencia Part n°
3/4"	1"1/16 12h UN	Z641391712
1"	1"5/16 12h UN	Z641392116
1"1/4	1"5/8 12h UN	Z641392620
1"1/2	1"7/8 12h UN	Z641393024
2"	2"1/2 12h UN	Z641394032



Bajo Consulta
On Request

Conexiones Interlock

Interlock series
Emboutis Interlock
Serie Interlock

Hembras gir rectas Métricas 24° Interlock con junta tórica

Metric swivel female 24° seat serie S Interlock with o'ring

Femelle droite Métrique 24° Interlock avec o'ring

Femmina Metrica sede 24° con o'ring serie S Interlock



DN	TUBO PIPE	SERIE SERIES	ROSCA THREAD	Referencia Part n°
3/4"	20	S	M30x2	Z64204302012
3/4"	25	S	M36x2	Z64204362512
1"	30	S	M42x2	Z64204423016
1"1/4	38	S	M52x2	Z64204523820
1"1/2	38	S	M52x2	Z64204523824

Hembras 90° Métricas cono 24° Interlock con junta tór

Metric swivel female 24° seat serie S Interlock with o'ring (90° Elbow)

Coude 90° femelle Métrique 24° Interlock avec o'ring

Femmina Metrica 90° sede 24° con o'ring serie S Interlock



DN	TUBO PIPE	SERIE SERIES	ROSCA THREAD	Referencia Part n°
3/4"	20	S	M30x2	Z64205302012
3/4"	25	S	M36x2	Z64205362512
1"	30	S	M42x2	Z64205423016
1"1/4	38	S	M52x2	Z64205523820
1"1/2	38	S	M52x2	Z64205523824

Hembras 45° Métricas cono 24° Interlock con junta tór

Metric swivel female 24° seat serie S Interlock with o'ring (45° Elbow)

Coude 45° femelle Métrique 24° Interlock avec o'ring

Femmina Metrica 45° sede 24° serie S Interlock



DN	TUBO PIPE	SERIE SERIES	ROSCA THREAD	Referencia Part n°
3/4"	20	S	M30x2	Z64206302012
3/4"	25	S	M36x2	Z64206362512
1"	30	S	M42x2	Z64206423016
1"1/4	38	S	M52x2	Z64206523820

Machos Métricos cono 24° Interlock

Metric male stud 24° cone serie S Interlock

Mâle Métrique cône 24° Interlock

Maschio Metrico sede 24° con o'ring serie S Interlock



DN	TUBO PIPE	SERIE SERIES	ROSCA THREAD	Referencia Part n°
3/4"	20	S	M30x2	Z64203302012
3/4"	25	S	M36x2	Z64203362512
1"	30	S	M42x2	Z64203423016
1"1/4	38	S	M52x2	Z64203523820

Hembras giratorias rectas ORFS Interlock

Interlock ORFS Swivel female straight

Femelle droite ORFS Interlock

Femmina diritta ORFS Interlock



DN	ROSCA THREAD	Referencia Part n°
3/4"	1"3/16-12h	Z649011912
1"	1"7/16-12h	Z649012316
1"1/4	1"11/16-12h	Z649012720
1"1/2	2"-12h	Z649013224

Machos ORFS Interlock

Interlock ORFS Male

Mâle ORFS Interlock

Maschio ORFS Interlock



DN	ROSCA THREAD	Referencia Part n°
3/4"	1"3/16-12h	Z649121912
1"	1"7/16-12h	Z649122316
1"1/4	1"11/16-12h	Z649122720
1"1/2	2"-12h	Z649123224

Hembras giratorias 90° ORFS Interlock

Interlock ORFS Swivel female (90° Elbow)

Coude 90° femelle ORFS Interlock

Femmina 90° ORFS Interlock



DN	ROSCA THREAD	Referencia Part n°
3/4"	1"3/16-12h	Z649071912
1"	1"7/16-12h	Z649072316
1"1/4	1"11/16-12h	Z649072720
1"1/2	2"-12h	Z649073224

Hembras giratorias 45° ORFS Interlock

Interlock ORFS Swivel female (45° Elbow)

Coude 45° femelle ORFS Interlock

Femmina 45° ORFS Interlock



DN	ROSCA THREAD	Referencia Part n°
3/4"	1"3/16-12h	Z649081912
12	1"7/16-12h	Z649082316
1"1/4	1"11/16-12h	Z649082720
1"1/2	2"-12h	Z649083224

Conexiones Interlock

Interlock series
Embouts Interlock
Serie Interlock

Bridas rectas SAE 3000 PSI Interlock

3000 PSI SAE Straight Flange Interlock / Code 61

Bride SAE droite série 3000 PSI Interlock

Flangia diritta SAE 3000 Interlock



DN	ø	Referencia Part n°
3/4"	38,1	Z641821212
3/4"	44,5	Z641821612
1"	44,5	Z641821616
1"	50,8	Z641822016
1"1/4	50,8	Z641822020
1"1/4	60,3	Z641822420
1"1/2	60,3	Z641822424
1"1/2	71,4	Z641823224
2"	71,4	Z641823232

Bridas 90° SAE 3000 PSI Interlock

3000 PSI SAE Flange Interlock (90° Elbow) / Code 61

Coude 90° bride SAE série 3000 PSI Interlock

Flangia 90° SAE 3000 Interlock



DN	ø	Referencia Part n°
3/4"	38,1	Z641831212
3/4"	44,45	Z641831612
1"	44,45	Z641831616
1"	50,8	Z641832016
1"1/4	50,8	Z641832020
1"1/4	60,33	Z641832420
1"1/2	60,3	Z641832424
1"1/2	71,4	Z641833224
2"	71,4	Z641833232

Bridas 45° SAE 3000 PSI Interlock

3000 PSI SAE Flange Interlock (45° Elbow) / Code 61

Coude 45° bride SAE série 3000 PSI Interlock

Flangia 45° SAE 3000 Interlock



DN	ø	Referencia Part n°
3/4"	38,1	Z641841212
3/4"	44,5	Z641841612
1"	44,5	Z641841616
1"	50,8	Z641842016
1"1/4	50,8	Z641842020
1"1/4	60,3	Z641842420
1"1/2	60,3	Z641842424
2"	71,4	Z641843224
2"	71,4	Z641843232

Bridas Rectas SAE 6000 PSI Interlock

6000 PSI SAE Straight Flange Interlock / Code 62

Bride SAE droite série 6000 PSI Interlock

Flangia diritta SAE 6000 Interlock



DN	ø	Referencia Part n°
3/4"	41,3	Z642821212
3/4"	47,63	Z642821612
1"	47,63	Z642821616
1"	53,98	Z642822016
1"1/4	54	Z642822020
1"1/4	63,5	Z642822420
1"1/2	63,5	Z642822424
1"1/2	79,38	Z642823224
2"	79,38	Z642823232

Bridas 90° SAE 6000 PSI Interlock

6000 PSI SAE Flange Interlock (90° Elbow) / Code 62

Coude 90° bride SAE série 6000 PSI Interlock

Flangia 90° SAE 6000 Interlock



DN	ø	Referencia Part n°
3/4"	41,3	Z642831212
3/4"	47,65	Z642831612
1"	47,65	Z642831616
1"	54	Z642832016
1"1/4	54	Z642832020
1"1/4	63,5	Z642832420
1"1/2	63,5	Z642832424
1"1/2	79,4	Z642833224
2"	79,4	Z642833232

Bridas 45° SAE 6000 PSI Interlock

6000 PSI SAE Flange Interlock (45° Elbow) / Code 62

Coude 45° bride SAE série 6000 PSI Interlock

Flangia 45° SAE 6000 Interlock



DN	ø	Referencia Part n°
3/4"	41,3	Z642841212
3/4"	47,6	Z642841612
1"	47,6	Z642841616
1"	54	Z642842016
1"1/4	54	Z642842020
1"1/4	63,5	Z642842420
1"1/2	63,5	Z642842424
1"1/2	79,4	Z642843224
2"	79,4	Z642843232

Casquillos para conexiones una sola pieza

Ferrules for one piece fittings
Jupes pour embouts pré-sertis
Boccole per raccordi compatti

Casquillos R1AT/R2AT/1SN/2SN /R16/2SC/R17 serie 43

Ferrules R1AT/R2AT/1SN/2SN/R16/2SC/R17 for one piece fittings 43 series

Jupes R1AT/R2AT/1SN/2SN/R16/2SC/R17 pour embouts pré-sertis série 43

Boccole a pressione R1AT/R2AT/1SN/2SN/R16/2SN/R17 per raccordi compatti serie 43



DN	Referencia Part n°
1/4"	ZPFC221200400
5/16"	ZPFC221200500
3/8"	ZPFC221200600
1/2"	ZPFC221200800
5/8"	ZPFC221201000
3/4"	ZPFC221201200
1"	ZPFC221201600
1" 1/4	ZPFC221202000
1" 1/2	ZPFC221202400
2"	ZPFC221203200

Casquillos 3SP/4SP/R12/4SH serie standard no p

Ferrules 3SP/4SP/R12/4SH standard series non skive

Jupes 3SP/4SP/R12/4SH série standard sans dénudage

Boccole a pressione per 3SP/4SP/R12/4SH per Serie Standard senza spellatura



DN	Referencia Part n°
3/8"	ZPF222400600
1/2"	ZPF222400800
5/8"	ZPF222401000
3/4"	ZPF222401200
1"	ZPF222401600
1" 1/4	ZPF222402000
1" 1/2	ZPF222402400
2"	ZPF222403200

Casquillos R7, R8 y elastómero malla metálica una

Ferrules R7, R8 and braid of steel wire for one piece fittings

Jupes R7, R8 et elastomère tresse métallique pour embouts pré-sertis

Boccole a pressione R7, R8 per raccordi compatti



DN	Referencia Part n°
3/16"	880120300
1/4"	880120400
5/16"	880120500
3/8"	880120600
1/2"	880120800
5/8"	880121000
3/4"	880121200
1"	880121600

Casquillos PTFE Liso una sola pieza

Ferrules smooth PTFE for one piece fittings

Jupes PTFE Lisse pour embouts pré-sertis

Boccole a pressione PTFE liscio per raccordi compatti



DN	Referencia Part n°
1/4"	880400400
5/16"	880400500
3/8"	880400600
1/2"	880400800
5/8"	880401000

Casquillos PTFE Corrugado una sola pieza

Ferrules convoluted PTFE for one piece fittings

Jupes PTFE Convoluté pour embouts pré-sertis

Boccole a pressione PTFE corrugato per raccordi compatti



DN	Referencia Part n°
1/4"	880410400
5/16"	880410500
3/8"	880410600
1/2"	880410800
5/8"	880411000
3/4"	880411200

Casquillos 1SC/1SN/2SC/R6

Ferrules 1SC/1SN/2SC/R6

Jupes 1SC/1SN/2SC/R6

Boccole a pressione per 1SC/1SN/2SC/R6 serie compatta



DN	Referencia Part n°
1/4"	ZSCC21120400
5/16"	ZSCC21120500
3/8"	ZSCC21120600
1/2"	ZSCC21120800
5/8"	ZSCC21121000
3/4"	ZSCC21121200
1"	ZSCC21121600

Casquillos R13/R15 para serie BW/BW+

Ferrules R13/R15 for fittings BW/BW+ series

Jupes R13/R15 pour embouts série BW/BW+

Boccole a pressione per R13/R15 per raccordi serie BW/BW+



DN	Referencia Part n°
1" 1/4	ZAC690102000
1" 1/2	ZAC690102400
2"	ZAC690103200

Conexiones una sola pieza Serie 43 R1AT/R2AT/1SN/2SN/R16/2SC/R17

One piece fittings 43 Series R1AT/R2AT/1SN/2SN/R16/2SC/R17
Emboutis pré-sertis R1AT/R2AT/1SN/2SN/R16/2SC/R17 Série 43
Raccordi compatti R1AT/R2AT/1SN/2SN/R16/2SC/R17 Serie 43

Hembras giratorias rectas una sola pieza JIC 37° doble hexagonal

One piece double hexagonal JIC 37° Swivel female

Femelle pré-sertie JIC 37° double hexagonal

Femmina diritta compatta JIC 37° doppio esagono



DN	ROSCA THREAD	Referencia Part n°
1/4"	7/16" 20h UNF	882420704
1/4"	1/2" 20h UNF	882420804
1/4"	9/16" 18h UNF	882420904
3/8"	9/16" 18h UNF	882420906
5/16"	1/2" 20h UNF	882420805
3/8"	3/4" 16h UNF	882421206
1/2"	3/4" 16h UNF	882421208
5/8"	3/4" 16h UNF	NEW 882421210
3/4"	3/4" 16h UNF	882421212
1/2"	7/8" 14h UNF	882421408
5/8"	7/8" 14h UNF	882421410
5/8"	1"1/16 12h UN	882421710
3/4"	1"1/16 12h UN	882421712
1"	1"1/16 12h UN	882421716
3/4"	1"5/16 12h UN	882422112
1"	1"5/16 12h UN	882422116
1"1/4	1"5/8 12h UN	882422620
1"1/2	1"7/8 12h UN	882423024
2"	2"1/2 12h UN	882424032

Machos una sola pieza rosca JIC 37°

One piece JIC 37° male

Mâle pré-serti JIC 37°

Maschio compatto JIC sede 37°



DN	ROSCA THREAD	Referencia Part n°
1/4"	7/16" 20h UNF	881400704
3/8"	9/16" 18h UNF	881400906
1/2"	3/4" 16h UNF	881401208
3/8"	7/8" 14h UNF	881401406
1/2"	7/8" 14h UNF	881401408
5/8"	7/8" 14h UNF	881401410
5/8"	1"1/16 12h UN	881401710
3/4"	1"1/16 12h UN	881401712
1"	1"1/16 12h UN	881401716
3/4"	1"5/16 12h UN	881402112
1"	1"5/16 12h UN	881402116
1"1/4	1"5/8 12h UN	881402620
1"1/2	1"7/8 12h UN	881403024
2"	2"1/2 12h UN	881404032

Hembras giratorias rectas una sola pieza JIC 37°

One piece JIC 37° Swivel female

Femelle pré-sertie JIC 37°

Femmina diritta compatta JIC 37°



DN	ROSCA THREAD	Referencia Part n°
1/4"	7/16" 20h UNF	881420704
1/4"	1/2" 20h UNF	881420804
5/16"	1/2" 20h UNF	881420805
1/4"	9/16" 18h UNF	881420904
5/16"	9/16" 18h UNF	881420905
3/8"	9/16" 18h UNF	881420906
3/8"	3/4" 16h UNF	881421206
1/2"	3/4" 16h UNF	881421208
1/2"	7/8" 14h UNF	881421408
5/8"	7/8" 14h UNF	881421410
1/2"	1"1/16 12h UN	881421708
5/8"	1"1/16 12h UN	881421710
3/4"	1"1/16 12h UN	881421712
1"	1"1/16 12h UN	881421716
3/4"	1"5/16 12h UN	881422112
1"	1"5/16 12h UN	881422116
5/8"	1"5/8 12h UN	881422616
1"1/4	1"5/8 12h UN	881422620
1"1/2	1"7/8 12h UN	881423024
2"	2"1/2 12h UN	881424032

Conexiones una sola pieza Serie 43 R1AT/R2AT/1SN/2SN/R16/2SC/R17

One piece fittings 43 Series R1AT/R2AT/1SN/2SN/R16/2SC/R17
 Embouts pré-sertis R1AT/R2AT/1SN/2SN/R16/2SC/R17 Série 43
 Raccordi compatti R1AT/R2AT/1SN/2SN/R16/2SC/R17 Serie 43

Hembras giratorias 90º una sola pieza JIC 37º

One piece JIC 37º Swivel female (90º Elbow)

Coûde 90º femelle pré-sertie JIC 37º

Femmina 90º compatta JIC 37º



DN	ROSCA THREAD	Referencia Part nº
1/4"	7/16" 20h UNF	881380704
5/16"	1/2" 20h UNF	881380805
1/4"	9/16" 18h UNF	881380904
5/16"	9/16" 18h UNF	NEW 881380905
3/8"	9/16" 18h UNF	881380906
3/8"	3/4" 16h UNF	881381206
1/2"	3/4" 16h UNF	881381208
1/2"	7/8" 14h UNF	881381408
5/8"	7/8" 14h UNF	881381410
5/8"	1"1/16 12h UN	NEW 881381710
3/4"	1"1/16 12h UN	881381712
3/4"	1"5/16 12h UN	881382112
1"	1"5/16 12h UN	881382116
1"1/4	1"5/8 12h UN	881382620
1"1/2	1"7/8 12h UN	881383024
2"	2"1/2 12h UN	881384032

Hembras giratorias 45º una sola pieza JIC 37º

One piece JIC 37º Swivel female (45º Elbow)

Coûde 45º femelle pré-sertie JIC 37º

Femmina 45º compatta JIC 37º



DN	ROSCA THREAD	Referencia Part nº
1/4"	7/16" 20h UNF	881390704
1/4"	9/16" 18h UNF	881390904
3/8"	9/16" 18h UNF	881390906
3/8"	3/4" 16h UNF	881391206
1/2"	3/4" 16h UNF	881391208
1/2"	7/8" 14h UNF	881391408
5/8"	7/8" 14h UNF	881391410
3/4"	1"1/16 12h UN	881391712
1"	1"5/16 12h UN	881392116
1"1/4	1"5/8 12h UN	881392620
1"1/2	1"7/8 12h UN	881393024
2"	2"1/2 12h UN	881394032

Conexiones una sola pieza Serie 43 R1AT/R2AT/1SN/2SN/R16/2SC/R17

One piece fittings 43 Series R1AT/R2AT/1SN/2SN/R16/2SC/R17
Emboutis pré-sertis R1AT/R2AT/1SN/2SN/R16/2SC/R17 Série 43
Raccordi compatti R1AT/R2AT/1SN/2SN/R16/2SC/R17 Serie 43

Hembras giratorias rectas una sola pieza ORFS doble hexagonal

One piece double hexagonal ORFS Swivel female

Femelle pré-sertie ORFS double hexagonal

Femmina diritta compatta ORFS doppio esagono



DN	ROSCA THREAD	Referencia Part n°
1/4"	9/16"-18h	889000904
1/4"	11/16"-16h	889001104
3/8"	11/16"-16h	889001106
3/8"	13/16"-16h	889001306
1/2"	13/16"-16h	889001308
1/2"	1"-14h	889001608
5/8"	1"-14h	889001610
1/2"	1"3/16-12h	889001908
5/8"	1"3/16-12h	889001910
3/4"	1"3/16-12h	889001912
3/4"	1"7/16-12h	889002312
1"	1"7/16-12h	889002316
1"1/4	1"11/16-12h	889002720
1"1/2	2"-12h	889003224

Hembras giratorias 90º una sola pieza ORFS

One piece ORFS Swivel female (90° Elbow)

Coude 90° femelle pré-sertie ORFS

Femmina 90° compatta ORFS



DN	ROSCA THREAD	Referencia Part n°
1/4"	9/16"-18h	889070904
1/4"	11/16"-16h	889071104
3/8"	11/16"-16h	889071106
3/8"	13/16"-16h	889071306
1/2"	13/16"-16h	889071308
1/2"	1"-14h	889071608
5/8"	1"-14h	889071610
3/4"	1"3/16-12h	889071912
3/4"	1-7/16-12h	889072312
1"	1"7/16-12h	889072316
1"1/4	1"11/16-12h	889072720
1"1/2	2"-12h	889073224

Machos una sola pieza ORFS

One piece ORFS male

Mâle pré-serti ORFS

Maschio compatto ORFS



DN	ROSCA THREAD	Referencia Part n°
1/4"	9/16"-18h	889120904
3/8"	11/16"-16h	889121106
1/2"	13/16"-16h	889121308
5/8"	1"-14h	889121610
3/4"	1"3/16-12h	889121912
1"	1"7/16-12h	889122316
1"1/4	1"11/16-12h	889122720
1"1/2	2"-12h	889123224

Hembras giratorias 45º una sola pieza ORFS

One piece ORFS Swivel female (45° Elbow)

Coude 45° femelle pré-sertie ORFS

Femmina 45° compatta ORFS



DN	ROSCA THREAD	Referencia Part n°
1/4"	9/16"-18h	889080904
1/4"	11/16"-16h	889081104
3/8"	11/16"-16h	889081106
3/8"	13/16"-16h	889081306
1/2"	13/16"-16h	889081308
1/2"	1"-14h	889081608
5/8"	1"-14h	889081610
3/4"	1"3/16-12h	889081912
3/4"	1"7/16-12h	889082312
1"	1"7/16-12h	889082316
1"1/4	1"11/16-12h	889082720
1"1/2	2"-12h	889083224

Conexiones una sola pieza Serie 43 R1AT/R2AT/1SN/2SN/R16/2SC/R17

One piece fittings 43 Series R1AT/R2AT/1SN/2SN/R16/2SC/R17
 Embouts pré-sertis R1AT/R2AT/1SN/2SN/R16/2SC/R17 Série 43
 Raccordi compatti R1AT/R2AT/1SN/2SN/R16/2SC/R17 Serie 43

Hembras gir rectas una sola pieza rosca NPSM (60°) doble hex

One piece double hexagonal NPSM Swivel female 60° cone

Femelle pré-sertie NPSM cône 60° double hexagonal

Femmina diritta compatta NPSM sede 60° doppio esagono



DN	ROSCA THREAD	Referencia Part n°
1/4"	1/4" 18h NPSM	883610404
3/8"	3/8" 18h NPSM	883610606
1/2"	1/2" 14h NPSM	883610808
3/4"	3/4" 14h NPSM	883611212
1"	1" - 11 1/2 h NPSM	883611616

Hembras giratorias rectas una sola pieza rosca NPSM

One piece NPSM Swivel female 60° cone

Femelle pré-sertie NPSM cône 60°

Femmina diritta compatta NPSM sede 60°



DN	ROSCA THREAD	Referencia Part n°
1/4"	1/4" 18h NPSM	882610404
3/8"	3/8" 18h NPSM	882610606
1/2"	1/2" 14h NPSM	882610808
3/4"	3/4" 14h NPSM	882611212
1"	1" - 11 1/2 h NPSM	882611616
1"1/4"	1"1/4 - 11 1/2 h NPSM	882612020

Hembras giratorias 90° una sola pieza rosca NPSM co

One piece NPSM Swivel female 60° cone (90° Elbow)

Coûde 90° femelle pré-sertie NPSM cône 60°

Femmina 90° compatta NPSM sede 60°



DN	ROSCA THREAD	Referencia Part n°
1/4"	1/4" 18h NPSM	882620404
3/8"	3/8" 18h NPSM	882620606
1/2"	1/2" 14h NPSM	882620808
3/4"	3/4" 14h NPSM	882621212
1"	1" - 11 1/2 h NPSM	882621616

Hembras giratorias 45° una sola pieza rosca NPSM co

One piece NPSM Swivel female 60° cone (45° Elbow)

Coûde 45° femelle pré-sertie NPSM cône 60°

Femmina 45° compatta NPSM sede 60°



DN	ROSCA THREAD	Referencia Part n°
1/4"	1/4" 18h NPSM	882630404
3/8"	3/8" 18h NPSM	882630606
1/2"	1/2" 14h NPSM	882630808
3/4"	3/4" 14h NPSM	882631212
1"	1" - 11 1/2 h NPSM	882631616

Machos una sola pieza rosca cónica NPT

One piece NPT male pipe straight

Mâle pré-serti NPT

Maschio compatto conico NPT



DN	ROSCA THREAD	Referencia Part n°
1/4"	1/8" NPT	881610204
1/4"	1/4" NPT	881610404
3/8"	1/4" NPT	881610406
1/4"	3/8" NPT	881610604
3/8"	3/8" NPT	881610606
1/2"	3/8" NPT	881610608
1/4"	1/2" NPT	881610804
3/8"	1/2" NPT	881610806
1/2"	1/2" NPT	881610808
5/8"	1/2" NPT	881610810
3/4"	1/2" NPT	881610812
1/2"	3/4" NPT	881611208
5/8"	3/4" NPT	881611210
3/4"	3/4" NPT	881611212
3/4"	1" NPT	881611612
1"	1" NPT	881611616
1"1/4"	1"1/4 NPT	881612020
1"1/2"	1"1/2 NPT	881612424
2"	2" NPT	881613232

Machos giratorios una sola pieza rosca cónica NPT

One piece NPT swivel male

Mâle tournant pré-serti NPT

Maschio girevole compatto conico NPT



DN	ROSCA THREAD	Referencia Part n°
1/4"	1/4" NPT	881650404
3/8"	3/8" NPT	881650606
3/8"	1/2" NPT	881650806
1/2"	1/2" NPT	881650808
1/2"	3/4" NPT	881651208
3/4"	3/4" NPT	881651212
1"	1" NPT	881651616

CRIMPING FITTINGS
FOR HOSES

PIPE
FITTINGS

PIPE
FITTINGS II

ADAPTORS

WELDING
FITTINGS

INDUSTRIAL
FITTINGS

ACCESSORIES

CONTROL
COMPONENTS

FLOW
MEASURING

TRAILER LOK

Conexiones una sola pieza Serie 43 R1AT/R2AT/1SN/2SN/R16/2SC/R17

One piece fittings 43 Series R1AT/R2AT/1SN/2SN/R16/2SC/R17
Emboutis pré-sertis R1AT/R2AT/1SN/2SN/R16/2SC/R17 Série 43
Raccordi compatti R1AT/R2AT/1SN/2SN/R16/2SC/R17 Serie 43

Bridas rectas una sola pieza SAE 3000 PSI

One piece 3000 PSI SAE Straight Flange / Code 61

Bride SAE droite pré-sertie série 3000 PSI

Flangia diritta compatta SAE 3000 PSI



DN	∅	Referencia Part n°
1/2"	30,2	881820808
1/2"	38,1	881821208
3/4"	38,1	881821212
3/4"	44,5	881821612
1"	44,5	881821616
1"	50,8	881822016
1"1/4	50,8	881822020
1"1/4	60,3	881822420
1"1/2	60,3	881822424
1"1/2	71,4	881823224
2"	71,4	881823232

Bridas 90° una sola pieza SAE 3000 PSI

One piece 3000 PSI SAE Flange (90° Elbow)/ Code 61

Bride SAE coude 90° pré-sertie série 3000 PSI

Flangia 90° compatta SAE 3000 PSI



DN	∅	Referencia Part n°
1/2"	30,2	881830808
1/2"	38,1	881831208
3/4"	38,1	881831212
3/4"	44,5	881831612
1"	44,5	881831616
1"	50,8	881832016
1"1/4	50,8	881832020
1"1/4	60,3	881832420
1"1/2	60,3	881832424
1"1/2	71,4	881833224
2"	71,4	881833232

Bridas 45° una sola pieza SAE 3000 PSI

One piece 3000 PSI SAE Flange (45° Elbow)/ Code 61

Bride SAE coude 45° pré-sertie série 3000 PSI

Flangia 45° compatta SAE 3000 PSI



DN	∅	Referencia Part n°
1/2"	30,2	881840808
1/2"	38,1	881841208
3/4"	38,1	881841212
3/4"	44,5	881841612
1"	44,5	881841616
1"	50,8	881842016
1"1/4	50,8	881842020
1"1/4	60,3	881842420
1"1/2	60,3	881842424
2"	71,4	881843232

Bridas rectas una sola pieza SAE 6000 PSI

One piece 6000 PSI SAE Straight Flange / Code 62

Bride SAE droite pré-sertie série 6000 PSI

Flangia diritta compatta SAE 6000 PSI



DN	∅	Referencia Part n°
1/2"	31,8	882820808
3/4"	41,3	882821212
1"	47,6	882821616
1"1/4	54	882822020
1"1/2	63,5	882822424
2"	79,4	882823232

Bridas 90° una sola pieza SAE 6000 PSI

One piece 6000 PSI SAE Flange (90° Elbow)/ Code 62

Bride SAE coude 90° pré-sertie série 6000 PSI

Flangia 90° compatta SAE 6000 PSI



DN	∅	Referencia Part n°
1/2"	31,8	882830808
3/4"	41,3	882831212
1"	47,6	882831616
1"1/4	54	882832020
1"1/2	63,5	882832424
2"	79,4	882833232

Bridas 45° una sola pieza SAE 6000 PSI

One piece 6000 PSI SAE Flange (45° Elbow)/ Code 62

Bride SAE coude 45° pré-sertie série 6000 PSI

Flangia 45° compatta SAE 6000 PSI



DN	∅	Referencia Part n°
1/2"	31,8	882840808
3/4"	41,3	882841212
1"	47,6	882841616
1"1/4	54	882842020
1"1/2	63,5	882842424
2"	79,4	882843232

Conexiones una sola pieza Serie 43 R1AT/R2AT/1SN/2SN/R16/2SC/R17

One piece fittings 43 Series R1AT/R2AT/1SN/2SN/R16/2SC/R17
 Embouts pré-sertis R1AT/R2AT/1SN/2SN/R16/2SC/R17 Série 43
 Raccordi compatti R1AT/R2AT/1SN/2SN/R16/2SC/R17 Serie 43

Hembras gir rectas una sola pieza rosca Métrica cono 24° - DKO

One piece Metric female cone 24°

Femelle pré-sertie Métrique cône 24°

Femmina diritta compatta Metrica sede 24°



DN	TUBO PIPE	SERIE SERIES	ROSCA THREAD	Referencia Part n°
1/4"	6	L	M12x1.5	88804120604
1/4"	8	L	M14x1.5	88804140804
1/4"	10	L	M16x1.5	88804161004
3/8"	10	L	M16x1.5	88804161006
5/16"	10	L	M16x1.5	88804161005
1/4"	12	L	M18x1.5	88804181204
3/8"	12	L	M18x1.5	88804181206
1/2"	12	L	M18x1.5	88804181208
3/8"	15	L	M22x1.5	88804221506
1/2"	15	L	M22x1.5	88804221508
1/2"	18	L	M26x1.5	88804261808
5/8"	18	L	M26x1.5	88804261810
3/4"	18	L	M26x1.5	88804261812
3/4"	22	L	M30x2	88804302212
1"	28	L	M36x2	88804362816
1"1/4	35	L	M45x2	88804453520
1"1/4	42	L	M52x2	88804524220
1"1/2	42	L	M52x2	88804524224
1/4"	8	S	M16x1.5	88804160804
1/4"	10	S	M18x1.5	88804181004
1/4"	12	S	M20x1.5	88804201204
3/8"	12	S	M20x1.5	88804201206
1/2"	12	S	M20x1.5	88804201208
3/8"	16	S	M24x1.5	88804241606
1/2"	16	S	M24x1.5	88804241608
5/8"	20	S	M30x2	88804302010
3/4"	20	S	M30x2	88804302012
3/4"	25	S	M36x2	88804362512
1"	25	S	M36x2	88804362516
1"	30	S	M42x2	88804423016
1"1/4	38	S	M52x2	88804523820

Machos una sola pieza rosca Métrica cono 24°

One piece Metric male cone 24°

Mâle pré-serti Métrique cône 24°

Maschio compatto Metrico sede 24°



DN	TUBO PIPE	SERIE	ROSCA THREAD	Referencia Part n°
1/4"	6	L	M12x1.5	88203120604
1/4"	8	L	M14x1.5	88203140804
5/16"	10	L	M16x1.5	88203161005
3/8"	10	L	M16x1.5	88203161006
3/8"	12	L	M18x1.5	88203181206
1/2"	15	L	M22x1.5	88203221508
1/2"	18	L	M26x1.5	88203261808
5/8"	18	L	M26x1.5	88203261810
3/4"	22	L	M30x2	88203302212
1"	28	L	M36x2	88203362816
1"1/4	35	L	M45x2	88203453520
1"1/2	42	L	M52x2	88203524224
1/4"	8	S	M16x1.5	88203160804
1/4"	10	S	M18x1.5	88203181004
3/8"	12	S	M20x1.5	88203201206
1/2"	16	S	M24x1.5	88203241608
5/8"	20	S	M30x2	88203302010
3/4"	20	S	M30x2	88203302012
3/4"	25	S	M36x2	88203362512
1"	25	S	M36x2	88203362516
1"	30	S	M42x2	88203423016
1"1/4	38	S	M52x2	88203523820

CRIMPING FITTINGS FOR HOSES

PIPE FITTINGS

PIPE FITTINGS II

ADAPTORS

WELDING FITTINGS

INDUSTRIAL FITTINGS

ACCESSORIES

CONTROL COMPONENTS

FLOW MEASURING

TRALE LOK

Conexiones una sola pieza Serie 43 R1AT/R2AT/1SN/2SN/R16/2SC/R17

One piece fittings 43 Series R1AT/R2AT/1SN/2SN/R16/2SC/R17
Embouts pré-sertis R1AT/R2AT/1SN/2SN/R16/2SC/R17 Série 43
Raccordi compatti R1AT/R2AT/1SN/2SN/R16/2SC/R17 Serie 43

Hembras gir 90º una sola pieza Métricas cono 24º - DKO 90º

One piece Metric female cone 24º (90º Elbow)

Coûde 90º femelle pré-sertie Métrique cône 24º

Femmina 90º compatta Metrica sede 24º



Hembras gir 45º una sola pieza Métricas cono 24º - DKO 45º

One piece Metric female cone 24º (45º Elbow)

Coûde 45º femelle pré-sertie Métrique cône 24º

Femmina 45º compatta Metrica sede 24º



DN	TUBO PIPE	SERIE SERIES	ROSCA THREAD	Referencia Part nº
1/4"	6	L	M12x1,5	88305120604
1/4"	8	L	M14x1,5	88305140804
1/4"	10	L	M16x1,5	88305161004
5/16"	10	L	M16x1,5	88305161005
3/8"	10	L	M16x1,5	88305161006
1/4"	12	L	M18x1,5	88305181204
3/8"	12	L	M18x1,5	88305181206
1/2"	15	L	M22x1,5	88305221508
5/8"	18	L	M26x1,5	88305261810
3/4"	22	L	M30x2	88305302212
1"	28	L	M36x2	88305362816
1 1/4"	35	L	M45x2	88305453520
1 1/2"	42	L	M52x2	88305524224
1/4"	8	S	M16x1,5	88305160804
1/4"	10	S	M18x1,5	88305181004
1/4"	12	S	M20x1,5	88305201204
5/16"	12	S	M20x1,5	88305201205
3/8"	12	S	M20x1,5	88305201206
1/2"	16	S	M24x1,5	88305241608
5/8"	20	S	M30x2	88305302010
3/4"	20	S	M30x2	88305302012
3/4"	25	S	M36x2	88305362512
1"	25	S	M36x2	88305362516
1"	30	S	M42x2	88305423016
1 1/4"	38	S	M52x2	88305523820

DN	TUBO PIPE	SERIE	ROSCA THREAD	Referencia Part nº
1/4"	6	L	M12x1,5	88306120604
1/4"	8	L	M14x1,5	88306140804
1/4"	10	L	M16x1,5	88306161004
5/16"	10	L	M16x1,5	88306161005
3/8"	10	L	M16x1,5	88306161006
3/8"	12	L	M18x1,5	88306181206
3/8"	15	L	M22x1,5	NEW 88306221506
1/2"	15	L	M22x1,5	88306221508
1/2"	18	L	M26x1,5	88306261808
5/8"	18	L	M26x1,5	88306261810
3/4"	22	L	M30x2	88306302212
1"	28	L	M36x2	88306362816
1 1/4"	35	L	M45x2	88306453520
1 1/2"	42	L	M52x2	88306524224
1/4"	8	S	M16x1,5	88306160804
1/4"	10	S	M18x1,5	88306181004
1/4"	12	S	M20x1,5	88306201204
3/8"	10	S	M18x1,5	88306181006
3/8"	12	S	M20x1,5	88306201206
3/8"	14	S	M22x1,5	88306221406
1/2"	16	S	M24x1,5	88306241608
5/8"	20	S	M30x2	88306302010
3/4"	20	S	M30x2	88306302012
3/4"	25	S	M36x2	88306362512
1"	25	S	M36x2	88306362516
1"	30	S	M42x2	88306423016
1 1/4"	38	S	M52x2	88306523820

Conexiones una sola pieza Serie 43 R1AT/R2AT/1SN/2SN/R16/2SC/R17

One piece fittings 43 Series R1AT/R2AT/1SN/2SN/R16/2SC/R17
 Embouts pré-sertis R1AT/R2AT/1SN/2SN/R16/2SC/R17 Série 43
 Raccordi compatti R1AT/R2AT/1SN/2SN/R16/2SC/R17 Serie 43

Hembras giratorias rectas una sola pieza rosca BSP (60°) doble hex

One piece double hexagonal BSP female 60° cone

Femelle pré-sertie BSP cône 60° double hexagonal

Femmina diritta compatta BSP sede 60° doppio esagono



DN	ROSCA THREAD	Referencia Part n°
1/4"	1/4" BSP	884000404
5/16"	3/8" BSP	884000605
3/8"	3/8" BSP	884000606
1/2"	1/2" BSP	884000808
3/4"	3/4" BSP	884001212
1"	1" BSP	884001616
1"1/4	1"1/4 BSP	884002020
1"1/2	1"1/2 BSP	884002424
2"	2" BSP	884003232

Hembras giratorias rectas una sola pieza rosca BS

One piece BSP female 60° cone

Femelle pré-sertie BSP cône 60°

Femmina diritta compatta BSP sede 60°



DN	ROSCA THREAD	Referencia Part n°
1/4"	1/4" BSP	881000404
1/4"	3/8" BSP	881000604
5/16"	3/8" BSP	881000605
3/8"	3/8" BSP	881000606
1/2"	3/8" BSP	881000608
3/8"	1/2" BSP	881000806
1/2"	1/2" BSP	881000808
5/8"	1/2" BSP	881000810
5/8"	5/8" BSP	881001010
1/2"	3/4" BSP	881001208
5/8"	3/4" BSP	881001210
3/4"	3/4" BSP	881001212
3/4"	1" BSP	881001612
1"	1" BSP	881001616
1"1/4	1"1/4 BSP	881002020
1"1/2	1"1/2 BSP	881002424
2"	2" BSP	881003232

Hembras giratorias rectas compactas rosca BSP as

One piece BSP female flat seat

Femelle pré-sertie BSP fond plat

Femmina diritta compatta BSP sede piana



DN	ROSCA THREAD	Referencia Part n°
1/4"	1/4" BSP	882000404
3/8"	3/8" BSP	882000606
1/2"	1/2" BSP	882000808
3/4"	3/4" BSP	882001212
1"	1" BSP	882001616

Hembras giratorias 90° una sola pieza rosca BSP cono 60°

One piece BSP female cone 60° (90° Elbow)

Coûde 90° femelle pré-sertie BSP cône 60°

Femmina 90° compatta BSP sede 60°



DN	ROSCA THREAD	Referencia Part n°
1/4"	1/4" BSP	881070404
1/4"	3/8" BSP	881070604
3/8"	3/8" BSP	881070606
1/2"	3/8" BSP	881070608
3/8"	1/2" BSP	881070806
1/2"	1/2" BSP	881070808
5/8"	5/8" BSP	881071010
5/8"	3/4" BSP	881071210
3/4"	3/4" BSP	881071212
3/4"	1" BSP	881071612
1"	1" BSP	881071616
1"1/4	1"1/4 BSP	881072020
1"1/2	1"1/2 BSP	881072424
2"	2" BSP	881073232

Hembras giratorias 45° una sola pieza rosca BSP cono

One piece BSP female cone 60° (45° Elbow)

Coûde 45° femelle pré-sertie BSP cône 60°

Femmina 45° compatta BSP sede 60°



DN	ROSCA THREAD	Referencia Part n°
1/4"	1/4" BSP	881080404
3/8"	3/8" BSP	881080606
3/8"	1/2" BSP	881080806
1/2"	1/2" BSP	881080808
3/4"	3/4" BSP	881081212
1"	1" BSP	881081616
1"1/4	1"1/4 BSP	881082020
1"1/2	1"1/2 BSP	881082424
2"	2" BSP	881083232

Machos una sola pieza rosca cilíndrica BSP cono 60°

One piece BSP male 60° cone

Mâle pré-serti BSP cône 60°

Maschio compatto cilindrico BSP sede 60°



DN	ROSCA THREAD	Referencia Part n°
1/4"	1/4" BSP	881120404
3/8"	3/8" BSP	881120606
3/8"	1/2" BSP	881120806
1/2"	1/2" BSP	881120808
5/8"	3/4" BSP	NEW 881121210
3/4"	3/4" BSP	881121212
3/4"	1" BSP	881121612
1"	1" BSP	881121616
1"1/4	1"1/4 BSP	881122020
1"1/2	1"1/2 BSP	881122424
2"	2" BSP	881123232

CRIMPING FITTINGS
FOR HOSES

PIPE
FITTINGS

PIPE
FITTINGS II

ADAPTORS

WELDING
FITTINGS

INDUSTRIAL
FITTINGS

ACCESSORIES

CONTROL
COMPONENTS

FLOW
MEASURING

TRAILER LOK

Conexiones una sola pieza Serie BWS 3SP/4SP/R12/4SH No Pelar

One piece fittings BWS Series 3SP/4SP/R12/4SH No Skive
Embouts pré-sertis Série BWS 3SP/4SP/R12/4SH Sans dénuder
Raccordi Compatti Serie BWS 3SP/4SP/R12/4SH senza spellatura

R13 & R15 Ø 3/4" - 1"

Hembras giratorias rectas una sola pieza JIC 37º doble hexagonal

One piece double hexagonal JIC 37º Swivel female

Femelle pré-sertie JIC 37º double hexagonal

Femmina diritta JIC 37º doppio esagono



DN	ROSCA THREAD	Referencia Part nº
3/8"	9/16" 18h UNF	Z582420906
1/2"	3/4" 16h UNF	Z582421208
1/2"	7/8" 14h UNF	Z582421408
5/8"	7/8" 14h UNF	Z582421410
3/4"	1"1/16 12h UN	Z582421712
1"	1"1/16 12h UN	Z582421716
1"	1"5/16 12h UN	Z582422116
1"1/4	1"5/8 12h UN	Z582422620
1"1/2	1"7/8 12 UN	Z582423024
2"	2"1/2 12h UN	Z582424032

Hembras giratorias 90º una sola pieza JIC 37º

One piece JIC 37º Swivel female (90º Elbow)

Coude 90º femelle pré-sertie JIC 37º

Femmina 90º compatta JIC 37º



DN	ROSCA THREAD	Referencia Part nº
3/8"	9/16" 18h UNF	Z581380906
1/2"	3/4" 16h UNF	Z581381208
5/8"	7/8" 14h UNF	Z581381410
3/4"	1"1/16 12h UN	Z581381712
1"	1"5/16 12h UN	Z581382116
1"1/4	1"5/8 12h UN	Z581382620
1"1/2	1"7/8 12 UN	Z581383024
2"	2"1/2 12h UN	Z581384032

Machos una sola pieza rosca JIC 37º

One piece JIC 37º male

Mâle pré-serti JIC 37º

Maschio compatto JIC sede 37º



DN	ROSCA THREAD	Referencia Part nº
3/8"	9/16" 18h UNF	Z581400906
1/2"	3/4" 16h UNF	Z581401208
5/8"	7/8" 14h UNF	Z581401410
3/4"	1"1/16 12h UN	Z581401712
1"	1"5/16 12h UN	Z581402116
1"1/4	1"5/8 12h UN	Z581402620
1"1/2	1"7/8 12 UN	Z581403024
2"	2"1/2 12h UN	Z581404032

Hembras giratorias rectas una sola pieza JIC 37º

One piece JIC 37º Swivel female

Femelle pré-sertie JIC 37º

Femmina diritta compatta JIC 37º



DN	ROSCA THREAD	Referencia Part nº
3/8"	9/16" 18h UNF	Z581420906
1/2"	3/4" 16h UNF	Z581421208
5/8"	7/8" 14h UNF	Z581421410
3/4"	1"1/16 12h UN	Z581421712
1"	1"5/16 12h UN	Z581422116
1"	1"5/8 12h UN	Z581422616
1"1/4	1"5/8 12h UN	Z581422620
1"1/2	1"7/8 12 UN	Z581423024
2"	2"1/2 12h UN	Z581424032

Hembras giratorias 45º una sola pieza JIC 37º

One piece JIC 37º Swivel female (45º Elbow)

Coude 45º femelle pré-sertie JIC 37º

Femmina 45º compatta JIC 37º



DN	ROSCA THREAD	Referencia Part nº
3/8"	9/16" 18h UNF	Z581390906
1/2"	3/4" 16h UNF	Z581391208
5/8"	7/8" 14h UNF	Z581391410
3/4"	1"1/16 12h UN	Z581391712
1"	1"5/16 12h UN	Z581392116
1"1/4	1"5/8 12h UN	Z581392620
1"1/2	1"7/8 12 UN	Z581393024
2"	2"1/2 12h UN	Z581394032

Conexiones una sola pieza Serie BWS 3SP/4SP/R12/4SH No Pelar

One piece fittings BWS Series 3SP/4SP/R12/4SH No Skive
 Embouts pré-sertis Série BWS 3SP/4SP/R12/4SH Sans dénuder
 Raccordi Compatti Serie BWS 3SP/4SP/R12/4SH senza spellatura

R13 & R15 Ø 3/4" - 1"

Hembras giratorias rectas una sola pieza ORFS doble hexagonal

One piece double hexagonal ORFS Swivel female

Femelle pré-sertie ORFS double hexagonal

Femmina diritta compatta ORFS doppio esagono



DN	ROSCA THREAD	Referencia Part n°
3/8"	11/16" 16h UN	Z589001106
1/2"	13/16" 16h UN	Z589001308
5/8"	1" 14h UNS	Z589001610
3/4"	1"3/16 12h UN	Z589001912
1"	1"7/16 12h UN	Z589002316
1"1/4	1"11/16 12h UN	Z589002720
1"1/2	2" 12h UN	Z589003224

Hembras giratorias 90º una sola pieza ORFS

One piece ORFS Swivel female (90º Elbow)

Coude 90º femelle pré-sertie ORFS

Femmina 90º compatta ORFS



DN	ROSCA THREAD	Referencia Part n°
3/8"	11/16" 16h UN	Z589071106
1/2"	13/16" 16h UN	Z589071308
5/8"	1" 14h UNS	Z589071610
3/4"	1"3/16 12h UN	Z589071912
1"	1"7/16 12h UN	Z589072316
1"1/4	1"11/16 12h UN	Z589072720
1"1/2	2" 12h UN	Z589073224

Machos una sola pieza ORFS

One piece ORFS male

Mâle pré-serti ORFS

Maschio compatto ORFS



DN	ROSCA THREAD	Referencia Part n°
3/8"	11/16" 16h UN	Z589121106
1/2"	13/16" 16h UN	Z589121308
5/8"	1" 14h UNS	Z589121610
3/4"	1"3/16 12h UN	Z589121912
1"	1"7/16 12h UN	Z589122316
1"1/4	1"11/16 12h UN	Z589122720
1"1/2	2" 12h UN	Z589123224

Hembras giratorias 45º una sola pieza ORFS

One piece ORFS Swivel female (45º Elbow)

Coude 45º femelle pré-sertie ORFS

Femmina 45º compatta ORFS



DN	ROSCA THREAD	Referencia Part n°
3/8"	11/16" 16h UN	Z589081106
1/2"	13/16" 16h UN	Z589081308
5/8"	1" 14h UNS	Z589081610
3/4"	1"3/16 12h UN	Z589081912
1"	1"7/16 12h UN	Z589082316
1"1/4	1"11/16 12h UN	Z589082720
1"1/2	2" 12h UN	Z589083224

Conexiones una sola pieza Serie BWS 3SP/4SP/R12/4SH No Pelar

One piece fittings BWS Series 3SP/4SP/R12/4SH No Skive
Embouts pré-sertis Série BWS 3SP/4SP/R12/4SH Sans dénuder
Raccordi Compatti Serie BWS 3SP/4SP/R12/4SH senza spellatura

R13 & R15 Ø 3/4" - 1"

Hembras giratorias rectas una sola pieza NPSM (60°) doble hex

One piece double hexagonal NPSM Swivel female 60° cone
Femelle pré-sertie NPSM cône 60° double hexagonal
Femmina diritta compatta NPSM sede 60° doppio esagono



DN	ROSCA THREAD	Referencia Part n°
3/8"	3/8" NPSM	Z583610606
1/2"	1/2" NPSM	Z583610808
3/4"	3/4" NPSM	Z583611212
1"	1" NPSM	Z583611616

Hembras giratorias 90° una sola pieza rosca NPSM co

One piece NPSM Swivel female 60° cone (90° Elbow)
Coude 90° femelle pré-sertie NPSM cône 60°
Femmina 90° compatta NPSM sede 60°



DN	ROSCA THREAD	Referencia Part n°
3/8"	3/8" NPSM	Z582620606
1/2"	1/2" NPSM	Z582620808
3/4"	3/4" NPSM	Z582621212
1"	1" NPSM	Z582621616

Machos una sola pieza rosca cónica NPT

One piece NPT male pipe straight
Mâle pré-serti NPT
Maschio compatto conico NPT



DN	ROSCA THREAD	Referencia Part n°
3/8"	3/8" NPT	Z581610606
1/2"	1/2" NPT	Z581610808
3/4"	3/4" NPT	Z581611212
1"	1" NPT	Z581611616
1"1/4	1"1/4 NPT	Z581612020
1"1/2	1"1/2 NPT	Z581612424
2"	2" NPT	Z581613232

Hembras giratorias rectas una sola pieza NPSM cono 60°

One piece NPSM Swivel female 60° cone
Femelle pré-sertie NPSM cône 60°
Femmina diritta compatta NPSM sede 60°



DN	ROSCA THREAD	Referencia Part n°
3/8"	3/8" NPSM	Z582610606
1/2"	1/2" NPSM	Z582610808
3/4"	3/4" NPSM	Z582611212
1"	1" NPSM	Z582611616
1"1/4	1"1/4 NPSM	Z582612020
1"1/2	1"1/2 NPSM	Z582612424
2"	2" NPSM	Z582613232

Hembras giratorias 45° una sola pieza rosca NPSM co

One piece NPSM Swivel female 60° cone (45° Elbow)
Coude 45° femelle pré-sertie NPSM cône 60°
Femmina 45° compatta NPSM sede 60°



DN	ROSCA THREAD	Referencia Part n°
3/8"	3/8" NPSM	Z582630606
1/2"	1/2" NPSM	Z582630808
3/4"	3/4" NPSM	Z582631212
1"	1" NPSM	Z582631616

Machos giratorios una sola pieza rosca cónica NPT

One piece NPT swivel male
Mâle tournant pré-serti NPT
Maschio girevole compatto conico NPT



DN	ROSCA THREAD	Referencia Part n°
3/8"	3/8" NPT	Z581650606
1/2"	1/2" NPT	Z581650808
3/4"	3/4" NPT	Z581651212
1"	1" NPT	Z581651616

Conexiones una sola pieza Serie BWS 3SP/4SP/R12/4SH No Pelar

One piece fittings BWS Series 3SP/4SP/R12/4SH No Skive
 Embouts pré-sertis Série BWS 3SP/4SP/R12/4SH Sans dénuder
 Raccordi Compatti Serie BWS 3SP/4SP/R12/4SH senza spellatura

R13 & R15 Ø 3/4" - 1"

Bridas rectas una sola pieza SAE 3000 PSI

One piece 3000 PSI SAE Straight Flange / Code 61

Bride SAE droite pré-sertie série 3000 PSI

Flangia diritta compatta SAE 3000 PSI



DN	Ø	Referencia Part n°
1/2"	30.2	Z581820808
5/8"	38.1	Z581821210
3/4"	38.1	Z581821212
1"	38.1	Z581821612
1"	44.5	Z581821616
1"1/4	50.8	Z581822020
1"1/2	60.3	Z581822424
2"	71.4	Z581823232

Bridas 90° una sola pieza SAE 3000 PSI

One piece 3000 PSI SAE Flange (90° Elbow)/ Code 61

Bride SAE coude 90° pré-sertie série 3000 PSI

Flangia 90° compatta SAE 3000 PSI



DN	Ø	Referencia Part n°
1/2"	30.2	Z581830808
5/8"	38.1	Z581831210
3/4"	38.1	Z581831212
3/4"	44.5	NEW Z581831612
1"	44.5	Z581831616
1"1/4	50.8	Z581832020
1"1/4	60.3	Z581832420
1"1/2	60.3	Z581832424
2"	71.4	Z581833232

Bridas 45° una sola pieza SAE 3000 PSI

One piece 3000 PSI SAE Flange (45° Elbow)/ Code 61

Bride SAE coude 45° pré-sertie série 3000 PSI

Flangia 45° compatta SAE 3000 PSI



DN	Ø	Referencia Part n°
1/2"	30.2	Z581840808
5/8"	38.1	Z581841210
3/4"	38.1	Z581841212
1"	44.5	Z581841616
1"1/4	50.8	Z581842020
1"1/2	60.3	Z581842424
2"	71.4	Z581843232

Bridas rectas una sola pieza SAE 6000 PSI

One piece 6000 PSI SAE Straight Flange / Code 62

Bride SAE droite pré-sertie série 6000 PSI

Flangia diritta compatta SAE 6000 PSI



DN	Ø	Referencia Part n°
1/2"	31.8	Z582820808
5/8"	41.3	Z582821210
3/4"	41.3	Z582821212
1"	47.6	Z582821616
1"	54.0	NEW Z582822016
1"1/4	54.0	Z582822020
1"1/2	63.5	Z582822424
2"	79.4	Z582823232

Bridas 90° una sola pieza SAE 6000 PSI

One piece 6000 PSI SAE Flange (90° Elbow)/ Code 62

Bride SAE coude 90° pré-sertie série 6000 PSI

Flangia 90° compatta SAE 6000 PSI



DN	Ø	Referencia Part n°
1/2"	31.8	Z582830808
5/8"	41.3	Z582831210
3/4"	41.3	Z582831212
1"	41.3	NEW Z582831612
1"	47.6	Z582831616
1"1/4	47.6	NEW Z582832016
1"1/4	54.0	Z582832020
1"1/4	63.5	Z582832420
1"1/2	63.5	Z582832424
2"	79.4	Z582833232

Bridas 45° una sola pieza SAE 6000 PSI

One piece 6000 PSI SAE Flange (45° Elbow)/ Code 62

Bride SAE coude 45° pré-sertie série 6000 PSI

Flangia 45° compatta SAE 6000 PSI



DN	Ø	Referencia Part n°
1/2"	31.8	Z582840808
5/8"	41.3	Z582841210
3/4"	41.3	Z582841212
1"	47.6	Z582841616
1"1/4	54.0	Z582842020
1"1/2	63.5	Z582842424
2"	79.4	Z582843232

Conexiones una sola pieza Serie BWS 3SP/4SP/R12/4SH No Pelar

One piece fittings BWS Series 3SP/4SP/R12/4SH No Skive
Embouts pré-sertis Série BWS 3SP/4SP/R12/4SH Sans dénuder
Raccordi Compatti Serie BWS 3SP/4SP/R12/4SH senza spellatura

R13 & R15 Ø 3/4" - 1"

Hembras gir rectas una sola pieza rosca Métrica cono 24° - DKO

One piece Metric female cone 24°

Femelle pré-sertie Métrique cône 24°

Femmina diritta compatta Metrica sede 24°



Machos una sola pieza rosca Métrica cono 24°

One piece Metric male cone 24°

Mâle pré-serti Métrique cône 24°

Maschio compatto Metrico sede 24°



DN	TUBO PIPE	SERIE SERIES	ROSCA THREAD	Referencia Part n°
3/8"	10	L	M16x1.5	Z58804161006
3/8"	12	L	M18x1.5	Z58804181206
3/8"	15	L	M22x1.5	Z58804221506
1/2"	15	L	M22x1.5	Z58804221508
1/2"	18	L	M26x1.5	Z58804261808
3/4"	18	L	M26x1.5	Z58804261812
5/8"	18	L	M26x1.5	Z58804261810
3/4"	22	L	M30x2	Z58804302212
1"	28	L	M36x2	Z58804362816
1 1/4	35	L	M45x2	Z58804453520
1 1/2	42	L	M52x2	Z58804524224
3/8"	12	S	M20x1.5	Z58804201206
1/2"	16	S	M24x1.5	Z58804241608
5/8"	20	S	M30x2	Z58804302010
3/4"	20	S	M30x2	Z58804302012
5/8"	25	S	M36x2	NEW Z58804362510
3/4"	25	S	M36x2	Z58804362512
1"	25	S	M36x2	NEW Z58804362516
1"	30	S	M42x2	Z58804423016
1 1/4	38	S	M45x2	Z58804523820

DN	TUBO PIPE	SERIE	ROSCA THREAD	Referencia Part n°
3/8"	10	L	M16x1.5	Z58203161006
3/8"	12	L	M18x1.5	Z58203181206
3/8"	15	L	M22x1.5	Z58203221506
1/2"	15	L	M22x1.5	Z58203221508
1/2"	18	L	M26x1.5	Z58203261808
5/8"	18	L	M26x1.5	Z58203261810
3/4"	22	L	M30x2	Z58203302212
1"	28	L	M36x2	Z58203362816
1 1/4	35	L	M45x2	Z58203453520
1 1/2	42	L	M52x2	Z58203524224
3/8"	12	S	M20x1.5	Z58203201206
1/2"	16	S	M24x1.5	Z58203241608
5/8"	20	S	M30x2	Z58203302010
3/4"	20	S	M30x2	Z58203302012
3/4"	25	S	M36x2	Z58203362512
1"	30	S	M42x2	Z58203423016
1 1/4	38	S	M45x2	Z58203523820

Hembras gir 90° una sola pieza Métricas cono 24° - DKO

One piece Metric female cone 24° (90° Elbow)

Coude 90° femelle pré-sertie Métrique cône 24°

Femmina 90° compatta Metrica sede 24°



One piece Metric female cone 24° (45° Elbow)

Coude 45° femelle pré-sertie Métrique cône 24°

Femmina 45° compatta Metrica sede 24°



DN	TUBO PIPE	ROSCA THREAD	SERIE SERIES	Referencia Part n°
3/8"	10	M16x1.5	L	Z58305161006
3/8"	12	M18x1.5	L	Z58305181206
1/2"	15	M22x1.5	L	Z58305221508
5/8"	18	M26x1.5	L	Z58305261810
3/4"	22	M30x2	L	Z58305302212
1"	28	M36x2	L	Z58305362816
1 1/4	35	M45x2	L	Z58305453520
1 1/2	42	M52x2	L	Z58305524224
3/8"	12	M20x1.5	S	Z58305201206
1/2"	16	M24x1.5	S	Z58305241608
5/8"	20	M30x2	S	Z58305302010
3/4"	20	M30x2	S	Z58305302012
3/4"	25	M36x2	S	Z58305362512
1"	25	M36x2	S	NEW Z58305362516
1"	30	M42x2	S	Z58305423016
1 1/4	38	M45x2	S	Z58305523820

DN	TUBO PIPE	SERIE	ROSCA THREAD	Referencia Part n°
3/8"	10	L	M16x1.5	Z58306161006
3/8"	12	L	M18x1.5	Z58306181206
1/2"	15	L	M22x1.5	Z58306221508
5/8"	18	L	M26x1.5	Z58306261810
3/4"	22	L	M30x2	Z58306302212
1"	28	L	M36x2	Z58306362816
1 1/4	35	L	M45x2	Z58306453520
1 1/2	42	L	M52x2	Z58306524224
3/8"	12	S	M20x1.5	Z58306201206
1/2"	16	S	M24x1.5	Z58306241608
5/8"	20	S	M30x2	Z58306302010
3/4"	20	S	M30x2	Z58306302012
3/4"	25	S	M36x2	Z58306362512
1"	25	S	M36x2	NEW Z58306362516
1"	30	S	M42x2	Z58306423016
1 1/4	38	S	M45x2	Z58306523820

Conexiones una sola pieza Serie BWS 3SP/4SP/R12/4SH No Pelar

One piece fittings BWS Series 3SP/4SP/R12/4SH No Skive
 Embouts pré-sertis Série BWS 3SP/4SP/R12/4SH Sans dénuder
 Raccordi Compatti Serie BWS 3SP/4SP/R12/4SH senza spellatura

R13 & R15 Ø 3/4" - 1"

Hembras giratoias rectas una sola pieza BSP (60°) doble hex

One piece double hexagonal BSP female 60° cone

Femelle pré-sertie BSP cône 60° double hexagonal

Femmina diritta compatta BSP sede 60° doppio esagono



DN	ROSCA THREAD	Referencia Part n°
3/8"	3/8" BSP	Z584000606
1/2"	1/2" BSP	Z584000808
3/4"	3/4" BSP	Z584001212
1"	1" BSP	Z584001616
1"1/4	1"1/4 BSP	Z584002020
1"1/2	1"1/2 BSP	Z584002424
2"	2" BSP	Z584003232

Hembras giratorias rectas una sola pieza BSP asiento plano

One piece BSP female flat seat

Femelle pré-sertie BSP fond plat

Femmina diritta compatta BSP sede piana



DN	ROSCA THREAD	Referencia Part n°
3/8"	3/8" BSP	Z582000606
1/2"	1/2" BSP	Z582000808
3/4"	3/4" BSP	Z582001212
1"	1" BSP	Z582001616
1"1/4	1"1/4 BSP	Z582002020
1"1/2	1"1/2 BSP	Z582002424
2"	2" BSP	Z582003232

Hembras giratorias 90° una sola pieza BSP C/J con

One piece BSP female cone 60° w/o ring (90° Elbow)

Coude 90° femelle pré-sertie BSP cône 60° avec joint

Femmina 90° compatta BSP sede 60° con o ring



DN	ROSCA THREAD	Referencia Part n°
3/8"	3/8" BSP	Z581170606
1/2"	1/2" BSP	Z581170808
3/4"	3/4" BSP	Z581171212
1"	1" BSP	Z581171616
1"1/4	1"1/4 BSP	Z581172020
1"1/2	1"1/2 BSP	Z581172424
2"	2" BSP	Z581173232

Hembras giratorias 45° una sola pieza BSP C/J cono 6

One piece BSP female cone 60° w/o ring (45° Elbow)

Coude 45° femelle pré-sertie BSP cône 60° avec joint

Femmina 45° compatta BSP sede 60° con o ring



DN	ROSCA THREAD	Referencia Part n°
3/8"	3/8" BSP	Z581180606
1/2"	1/2" BSP	Z581180808
3/4"	3/4" BSP	Z581181212
1"	1" BSP	Z581181616
1"1/4	1"1/4 BSP	Z581182020
1"1/2	1"1/2 BSP	Z581182424
2"	2" BSP	Z581183232

Machos una sola pieza rosca cilíndrica BSP cono 60

One piece BSP male 60° cone

Mâle pré-serti BSP cône 60°

Maschio compatto cilindrico BSP sede 60°



DN	ROSCA THREAD	Referencia Part n°
3/8"	3/8" BSP	Z581120606
1/2"	1/2" BSP	Z581120808
5/8"	5/8" BSP	Z581121010
3/4"	3/4" BSP	Z581121212
1"	1" BSP	Z581121616
1"1/4	1"1/4 BSP	Z581122016
1"1/4	1"1/4 BSP	Z581122020
1"1/2	1"1/2 BSP	Z581122424
2"	2" BSP	Z581123232

Hembras giratorias rectas una sola pieza BSP C/J cono

One piece BSP female 60° cone 60° w/o ring

Femelle pré-sertie BSP cône 60° avec joint

Femmina diritta compatta BSP sede 60° con o ring



DN MANGUERA DN HOSE	ROSCA THREAD	Referencia Part n°
3/8"	3/8" BSP	Z581100606
1/2"	1/2" BSP	Z581100808
3/4"	3/4" BSP	Z581101212
1"	1" BSP	Z581101616
1"1/4	1"1/4 BSP	Z581102020
1"1/2	1"1/2 BSP	Z581102424
2"	2" BSP	Z581103232

BWS



**NO PELAR
NO SKIVE**



MAYOR VERSATILIDAD. 1 CASQUILLO - 4 MANGUERAS
GREATER VERSATILITY. 1 FERRULE - 4 HOSES

+



REDUCCIÓN DE STOCK. USO DE ESPIGA STD
STOCK OPTIMISATION. STD SERIES

+



MENOR TIEMPO DE MONTAJE. NO PELAR
REDUCES ASSEMBLY TIME. NO SKIVE

=



AHORRO ECONÓMICO.
ECONOMIC EFFICIENCY

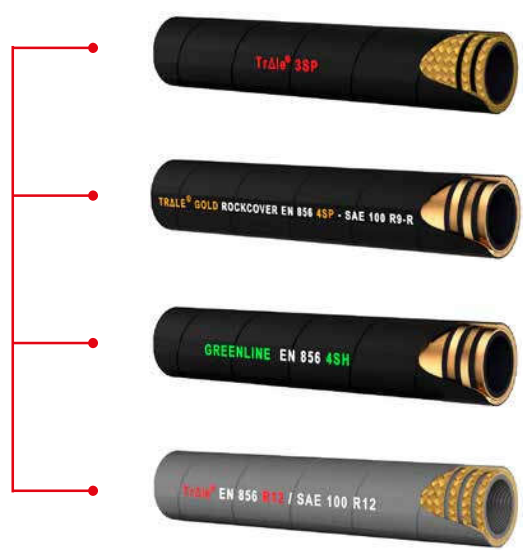

BW+



**NO PELAR
NO SKIVE**



ALTA PRESIÓN
HIGH PRESSURE

1" 1/4 - 1" 1/2-2

R13 - R15

+



REDUCCIÓN DE STOCK. USO DE ESPIGA BW
STOCK OPTIMISATION. BW SERIES

+



MENOR TIEMPO DE MONTAJE. NO PELAR
REDUCES ASSEMBLY TIME. NO SKIVE



Conexiones una pieza Serie BW+ R13/R15 No Pelar

One piece fittings BW+ Series R13/R15 No Skive

Embouts R13/R15 Série BW+ Sans denuder

Raccordi R13/R15 Serie BW+ senza spellatura

R13 & R15 Ø 3/4" - 1" ->>BWS

Hembras giratorias rectas una sola pieza JIC 37º doble hexagonal

One piece double hexagonal JIC 37º Swivel female

Femelle pré-sertie JIC 37º double hexagonal

Femmina diritta compatta JIC 37º doppio esagono



DN	ROSCA THREAD	Referencia Part nº
1"1/4	1"5/8 12 UN	Z692422620
1"1/2	1"7/8 12 UN	Z692423024
2"	2" 1/2 12 UN	Z692424032

Hembras giratorias 90º una sola pieza rosca JIC 37º

One piece JIC 37º Swivel female (90º Elbow)

Coûde 90º femelle pré-sertie JIC 37º

Femmina compatta 90º JIC 37º



DN	ROSCA THREAD	Referencia Part nº
1"1/4	1"5/8 12 UN	Z691382620
1"1/2	1"7/8 12 UN	Z691383024
2"	2" 1/2 12 UN	Z691384032

Machos una sola pieza rosca JIC 37º C/I

One piece JIC 37º male with o'ring

Mâle pré-serti JIC 37º avec joint torique

Maschio compatto JIC 37º con o'ring



DN	ROSCA THREAD	Referencia Part nº
1"1/4	1"5/8 12 UN	Z691412620
1"1/2	1"7/8 12 UN	Z691413024
2"	2" 1/2 12 UN	Z691414032

Hembras giratorias 45º una sola pieza rosca JIC 37º

One piece JIC 37º Swivel female (45º Elbow)

Coûde 45º femelle pré-sertie JIC 37º

Femmina compatta 45º JIC 37º



DN	ROSCA THREAD	Referencia Part nº
1"1/4	1"5/8 12 UN	Z691392620
1"1/2	1"7/8 12 UN	Z691393024
2"	2" 1/2 12 UN	Z691394032

Hembras giratorias rectas una sola pieza ORFS doble hexagonal

One piece ORFS Swivel female straight double hexagonal

Femelle pré-sertie droite ORFS double hexagonale

Femmina diritta compatta ORFS doppio esagono



DN	ROSCA THREAD	Referencia Part nº
1"1/4	1" 11/16 12 UN	Z699012720
1"1/2	2" 12 UN	Z699013224

Hembras giratorias 90º una sola pieza ORFS

One piece ORFS Swivel female (90º Elbow)

Coûde 90º femelle pré-sertie ORFS

Femmina 90º compatta ORFS



DN	ROSCA THREAD	Referencia Part nº
1"1/4	1" 11/16 12 UN	Z699072720
1" 1/2	2" 12 UN	Z699073224

Hembras giratorias 45º una sola pieza ORFS

One piece ORFS Swivel female (45º Elbow)

Coûde 45º femelle pré-sertie ORFS

Femmina 45º compatta ORFS



DN	ROSCA THREAD	Referencia Part nº
1"1/4	1"11/16 12 UN	Z699082720
1"1/2	2" 12 UN	Z699083224

Machos una sola pieza ORFS

One piece ORFS Male

Mâle pré-serti ORFS

Maschio compatto ORFS



DN	ROSCA THREAD	Referencia Part nº
1"1/4	1"11/16 12 UN	Z699122720
1"1/2	2" 12 UN	Z699123224

Conexiones una pieza Serie BW+ R13/R15 No Pelar

One piece fittings BW+ Series R13/R15 No Skive
Embouts R13/R15 Série BW+ Sans denuder
Raccordi R13/R15 Serie BW+ senza spellatura

R13 & R15 Ø 3/4" - 1" ->>BWS

Hembras gir rectas una sola pieza rosca NPSM (60°) doble hex

One piece double hexagonal NPSM female 60° cone

Femelle pré-sertie NPSM cône 60° double hexagonal

Femmina diritta compatta NPSM sede 60° doppio esagono



DN	ROSCA THREAD	Referencia Part n°
1"1/4	1"1/4 - 11 1/2 h NPSM	Z693612020
1"1/2	1"1/2 - 11 1/2 h NPSM	Z693612424
2"	2" - 11 1/2 h NPSM	Z693613232

Machos una sola pieza rosca cónica NPT

One piece NPT Male pipe straight

Mâle pré-serti conique NPT

Maschio compatto conico NPT



DN	ROSCA THREAD	Referencia Part n°
1"1/4	1"1/4 - 11 1/2 h NPSM	Z691612020
1"1/2	1"1/2 - 11 1/2 h NPSM	Z691612424
2"	2" - 11 1/2 h NPSM	Z691613232

Bridas recta SAE 6000 PSI

One piece 6000 PSI SAE Straight Flange / Code 62

Bride SAE droite pré-sertie série 6000 PSI

Flangia diritta compatta SAE 6000



DN	Ø	Referencia Part n°
1"1/4	1"1/4	Z692822020
1"1/2	1"1/2	Z692822424
2"	2"	Z692823232

Bridas a 90° SAE 6000 PSI

One piece 6000 PSI SAE Flange (90° Elbow) / Code 62

Bride SAE coude 90° pré-sertie série 6000 PSI

Flangia 90° compatta SAE 6000



DN	Ø	Referencia Part n°
1"1/4	1"1/4	Z692832020
1"1/2	1"1/2	Z692832424
2"	2"	Z692833232

Bridas a 45° SAE 6000 PSI

One piece 6000 PSI SAE Flange (45° Elbow) / Code 62

Bride SAE coude 45° pré-sertie série 6000 PSI

Flangia 45° compatta SAE 6000



DN	Ø	Referencia Part n°
1"1/4	1"1/4	Z692842020
1"1/2	1"1/2	Z692842424
2"	2"	Z692843232

Conexiones una pieza Serie BW+ R13/R15 No Pelar

One piece fittings BW+ Series R13/R15 No Skive

Embouts R13/R15 Série BW+ Sans denuder

Raccordi R13/R15 Serie BW+ senza spellatura

R13 & R15 Ø 3/4" - 1" ->>BWS

Hembras giratorias una pieza BSP 60° doble hex c/j tca eng.

One piece double hexagonal BSP Swivel female cone 60° with o'ring wire nut

Femelle BSP pré-sertie cône 60° double hexagonal with o'ring écrou à douille

Femmina diritta compatta BSP sede 60° doppio esagono con guarnizione dado spinato



DN	ROSCA THREAD	Referencia Part n°
1"1/4	1"1/4 BSP	Z695102020
1"1/2	1"1/2 BSP	Z695102424
2"	2" BSP	Z695103232

Machos cilíndricos una sola pieza BSP 60°

One piece BSP Male 60° cone

Mâle pré-serti gaz cylindrique BSP 60°

Maschio compatto BSP cilindrico sede 60°



DN	ROSCA THREAD	Referencia Part n°
1"1/4	1"1/4 BSP	Z691122020
1"1/2	1"1/2 BSP	Z691122424
2"	2" BSP	Z691123232

Hembras giratorias 90° una sola pieza BSP 60° c/j tca eng.

One piece BSP Swivel female 60° cone with o'ring (90° Elbow) wire nut

Coude 90° femelle pré-sertie BSP 60° avec o'ring écrou à douille

Femmina 90° compatta BSP sede 60° con o'ring dado spinato



DN	ROSCA THREAD	Referencia Part n°
1"1/4	1"1/4 BSP	Z695172020
1"1/2	1"1/2 BSP	Z695172424
2"	2" BSP	Z695173232

Hembras giratorias 45° una sola pieza BSP 60° c/j tc

One piece BSP Swivel female 60° cone with o'ring (45° Elbow) wire nut

Coude 45° femelle pré-sertie BSP 60° avec o'ring écrou à douille

Femmina 45° compatta BSP sede 60° con o'ring dado spinato



DN	ROSCA THREAD	Referencia Part n°
1"1/4	1"1/4 BSP	Z695182020
1"1/2	1"1/2 BSP	Z695182424
2"	2" BSP	Z695183232

BAJO CONSULTA
UNDER REQUEST

BW+ MÉTRICAS / METRIC BW+

■ Hembras giratorias rectas una sola pieza rosca Métrica cono 24° con junta tórica

One piece Metric swivel female 24° seat with o'ring



Ref: Z69204

■ Hembras giratorias 90° una sola pieza Métricas cono 24° con junta tórica

One piece Metric swivel female 24° seat with o'ring



Ref: Z69205

■ Macho una sola pieza Métricos cono 24°

One piece Metric male stud 24° cone



Ref: Z69203

■ Hembras giratorias 45° una sola pieza Métricas cono 24° con junta tórica

One piece Metric swivel female 24° seat with o'ring



Ref: Z69206

CRIMPING FITTINGS FOR HOSES
PIPE FITTINGS
PIPE FITTINGS II
ADAPTORS
WELDING FITTINGS
INDUSTRIAL FITTINGS
ACCESSORIES
CONTROL COMPONENTS
FLOW MEASURING
TRALE LOK

Conexiones una sola pieza R7/ R8/ Elastómero malla metálica

One piece fittings R7/R8 & Elastomer Braid of steel wire
Embouts pré-sertis R7/R8 et Elastomère tresse métallique
Raccordi compatti serie R7/R8 e elastomero treccia metallica

Hembras giratorias rectas una sola pieza rosca JIC 37° doble hex

One piece double hexagonal JIC 37° female

Femelle pré-sertie JIC 37° double hexagonal

Femmina diritta compatta JIC 37° doppio esagono



DN	ROSCA THREAD	Referencia Part n°
3/16"	7/16" 20h UNF	872420703
1/4"	7/16" 20h UNF	872420704
5/16"	7/16" 20h UNF	872420705
1/4"	9/16" 18h UNF	872420904
5/16"	9/16" 18h UNF	872420905
3/8"	9/16" 18h UNF	872420906
1/2"	3/4" 16h UNF	872421208
1/2"	7/8" 14h UNF	872421408
5/8"	1"1/16 12h UN	872421710
3/4"	1"1/16 12h UN	872421712
1"	1"5/16 12h UN	872422116

Hembras giratorias rectas una sola pieza rosca JIC 37°

One piece JIC 37° female

Femelle pré-sertie JIC 37°

Femmina diritta compatta JIC 37°



DN	ROSCA THREAD	Referencia Part n°
3/16"	7/16" 20h UNF	871420703
1/4"	7/16" 20h UNF	871420704
1/4"	9/16" 18h UNF	871420904
5/16"	9/16" 18h UNF	871420905
3/8"	9/16" 18h UNF	871420906
1/2"	3/4" 16h UNF	871421208
1/2"	7/8" 14h UNF	871421408
3/4"	1"1/16 12h UN	871421712
1"	1"5/16 12h UN	871422116

Hembras giratorias 45° una sola pieza rosca JIC 37°

One piece JIC 37° female (45° Elbow)

45° Femelle pré-sertie JIC 37°

Femmina 45° compatta JIC 37°



DN	ROSCA THREAD	Referencia Part n°
1/4"	7/16" 20h UNF	871390704
3/8"	9/16" 18h UNF	871390906
1/2"	3/4" 16h UNF	871391208
3/4"	1"1/16 12h UN	871391712
1"	1"5/16 12h UN	871392116

Hembras giratorias 90° una sola pieza rosca JIC 37°

One piece JIC 37° female (90° Elbow)

90° Femelle pré-sertie JIC 37°

Femmina 90° compatta JIC 37°



DN	ROSCA THREAD	Referencia Part n°
3/16"	7/16" 20h UNF	871380703
1/4"	7/16" 20h UNF	871380704
1/4"	9/16" 18h UNF	871380904
3/8"	9/16" 18h UNF	871380906
1/2"	3/4" 16h UNF	871381208
1/2"	7/8" 14h UNF	NEW 871381408
3/4"	1"1/16 12h UN	871381712
1"	1"5/16 12h UN	871382116

Machos una sola pieza rosca JIC 37°

One piece JIC 37° male

Mâle pré-serti JIC 37°

Maschio compatto JIC sede 37°



DN	ROSCA THREAD	Referencia Part n°
3/16"	7/16" 20h UNF	NEW 871400703
1/4"	7/16" 20h UNF	871400704
3/8"	9/16" 18h UNF	871400906
1/2"	3/4" 16h UNF	871401208
3/4"	1"1/16 12h UN	871401712
1"	1"5/16 12h UN	871402116

Conexiones una sola pieza R7/ R8/ Elastómero malla metálica

One piece fittings R7/R8 & Elastomer Braid of steel wire
 Embouts pré-sertis R7/R8 et Elastomère tresse métallique
 Raccordi compatti serie R7/R8 e elastomero treccia metallica

Hembras giratorias rectas una sola pieza rosca ORFS doble hex

One piece double hexagonal ORFS female

Femelle pré-sertie ORFS double hexagonal

Femmina diritta compatta ORFS



DN	ROSCA THREAD	Referencia Part n°
1/4"	9/16"-18h	879000904
3/8"	11/16"-16h	879001106
3/8"	13/16"-16h	879001306
1/2"	13/16"-16h	879001308
3/4"	1"3/16-12h	879001912
1"	1"7/16-12h	879002316

Hembras giratorias 90º una sola pieza rosca ORFS

One piece ORFS female (90º Elbow)

90º Femelle pré-sertie ORFS

Femmina 90º compatta ORFS



DN	ROSCA THREAD	Referencia Part n°
1/4"	9/16"-18h	879070904
3/8"	11/16"-16h	879071106
1/2"	13/16"-16h	879071308
3/4"	1"3/16-12h	879071912
1"	1"7/16-12h	879072316

Machos compactos rosca ORFS

One piece ORFS male

Mâle pré-serti ORFS

Maschio compatto ORFS



DN	ROSCA THREAD	Referencia Part n°
1/4"	9/16"-18h	879120904
3/8"	11/16"-16h	879121106
1/2"	13/16"-16h	879121308
3/4"	1"3/16-12h	879121912
1"	1"7/16-12h	879122316

Hembras giratorias 45º una sola pieza rosca ORFS

One piece ORFS female (45º Elbow)

45º Femelle pré-sertie ORFS

Femmina 45º compatta ORFS



DN	ROSCA THREAD	Referencia Part n°
1/4"	9/16"-18h	879080904
3/8"	11/16"-16h	879081106
1/2"	13/16"-16h	879081308
3/4"	1"3/16-12h	879081912
1"	1"7/16-12h	879082316

Configura tus propias conexiones en Una sola pieza (43/R7/R8/PTFE/BWS). Consúltanos

Configure your own One piece series fittings (43/R7/R8/PTFE/BWS). Consult us.

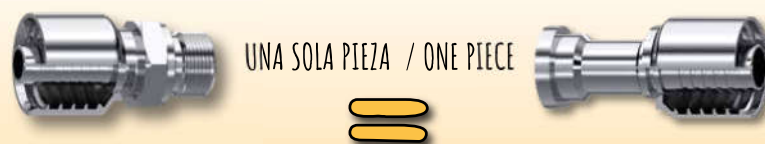

COMBINACIONES INFINITAS CONSÚLTANOS!

ENDLESS FITTINGS OPTIONS. FIND THEM OUT!



Conexiones una sola pieza R7/ R8/ Elastómero malla metálica

One piece fittings R7/R8 & Elastomer Braid of steel wire
Embouts pré-sertis R7/R8 et Elastomère tresse métallique
Raccordi compatti serie R7/R8 e elastomero treccia metallica

Hembras giratorias rectas una sola pieza NPSM (60°) doble hex

One piece double hexagonal NPSM female 60° cone

Femelle pré-sertie NPSM cône 60° double hexagonal

Femmina diritta compatta NPSM sede 60° doppio esagono



DN	ROSCA THREAD	Referencia Part n°
1/4"	1/4" NPSM	873610404
3/8"	3/8" 18h NPSM	873610606
1/2"	1/2" 14h NPSM	873610808
3/4"	3/4" NPSM	873611212
1"	1" - 11 1/2 h NPSM	873611616

Hembras giratorias rectas una sola pieza NPSM cono 60°

One piece NPSM female 60° cone

Femelle pré-sertie NPSM cône 60°

Femmina diritta compatta NPSM sede 60°



DN	ROSCA THREAD	Referencia Part n°
1/4"	1/4" 18h NPSM	872610404
3/8"	3/8" 18h NPSM	872610606
1/2"	1/2" 14h NPSM	872610808
3/4"	3/4" 14h NPSM	872611212
1"	1" - 11 1/2 h NPSM	872611616

Hembras giratorias 90° una sola pieza NPSM cono 60

One piece NPSM female 60° cone (90° Elbow)

90° Femelle pré-sertie NPSM cône 60°

Femmina 90° compatta NPSM sede 60°



DN	ROSCA THREAD	Referencia Part n°
1/4"	1/4" 18h NPSM	872620404
3/8"	3/8" 18h NPSM	872620606
1/2"	1/2" 14h NPSM	872620808
3/4"	3/4" 14h NPSM	872621212
1"	1" - 11 1/2 h NPSM	872621616

Hembras giratorias 45° una sola pieza NPSM cono 60

One piece NPSM female 60° cone (45° Elbow)

45° Femelle pré-sertie NPSM cône 60°

Femmina 45° compatta NPSM sede 60°



DN	ROSCA THREAD	Referencia Part n°
1/4"	1/4" 18h NPSM	872630404
3/8"	3/8" 18h NPSM	872630606
1/2"	1/2" 14h NPSM	872630808
3/4"	3/4" 14h NPSM	872631212
1"	1" - 11 1/2 h NPSM	872631616

Machos una sola pieza rosca cónica NPT

One piece NPT male pipe straight

Mâle pré-serti NPT

Maschio compatto conico NPT



DN	ROSCA THREAD	Referencia Part n°
1/4"	1/8" NPT	NEW 871610204
3/16"	1/4" NPT	871610403
1/4"	1/4" NPT	871610404
3/8"	1/4" NPT	871610406
1/4"	3/8" NPT	871610604
3/8"	3/8" NPT	871610606
1/2"	1/2" NPT	871610808
3/4"	1/2" NPT	NEW 871610812
3/4"	3/4" NPT	871611212
1"	1" NPT	871611616

Conexiones una sola pieza R7/ R8/ Elastómero malla metálica

One piece fittings R7/R8 & Elastomer Braid of steel wire
 Embouts pré-sertis R7/R8 et Elastomère tresse métallique
 Raccordi compatti serie R7/R8 e elastomero treccia metallica

Hembras gir rectas una sola pieza rosca Métrica cono 24° - DKO

One piece Metric female 24° cone

Femelle pré-sertie Métrique cône 24°

Femmina diritta compatta Metrica sede 24°



DN	TUBO PIPE	SERIE SERIES	ROSCA THREAD	Referencia Part n°
3/16"	6	L	M12x1,5	87804120603
1/4"	6	L	M12x1,5	87804120604
1/4"	8	L	M14x1,5	87804140804
3/8"	10	L	M16x1,5	87804161006
3/8"	12	L	M18x1,5	87804181206
1/2"	15	L	M22x1,5	87804221508
3/4"	22	L	M30x2	87804302212
1"	28	L	M36x2	87804362816
1/4"	8	S	M16x1,5	87804160804
1/4"	10	S	M18x1,5	87804181004
3/8"	12	S	M20x1,5	87804201206
1/2"	16	S	M24x1,5	87804241608
3/4"	20	S	M30x2	87804302012
3/4"	25	S	M36x2	87804362512
1"	30	S	M42x2	87804423016

Hembras gir 90° una sola pieza Métricas cono 24° - DK

One piece Metric female 24° cone (90° Elbow)

90° Femelle pré-sertie Métrique cône 24°

Femmina 90° compatta Metrica sede 24°



DN	TUBO PIPE	SERIE SERIES	ROSCA THREAD	Referencia Part n°
1/4"	8	L	M14x1,5	87305140804
3/8"	10	L	M16x1,5	87305161006
3/8"	12	L	M18x1,5	87305181206
1/2"	15	L	M22x1,5	87305221508
3/4"	22	L	M30x2	87305302212
1"	28	L	M36x2	87305362816
1/4"	8	S	M16x1,5	87305160804
1/4"	10	S	M18x1,5	87305181004
3/8"	12	S	M20x1,5	87305201206
1/2"	16	S	M24x1,5	87305241608
3/4"	25	S	M36x2	87305362512
1"	30	S	M42x2	87305423016

Machos una sola pieza rosca Métrica cono 24°

One piece Metric male 24° cone

Mâle pré-serti Métrique cône 24°

Maschio compatto Metrico sede 24°



DN	TUBO PIPE	SERIE SERIES	ROSCA THREAD	Referencia Part n°
1/4"	8	L	M14x1,5	87203140804
3/8"	12	L	M18x1,5	87203181206
1/2"	15	L	M22x1,5	87203221508
3/4"	22	L	M30x2	87203302212
1"	28	L	M36x2	87203362816
1/4"	8	S	M16x1,5	87203160804
1/4"	10	S	M18x1,5	87203181004
3/8"	12	S	M20x1,5	87203201206
1/2"	16	S	M24x1,5	87203241608
3/4"	25	S	M36x2	87203362512
1"	30	S	M42x2	87203423016

Hembras gir 45° una sola pieza Métricas cono 24° - DKO

One piece Metric female 24° cone (45° Elbow)

45° Femelle pré-sertie Métrique cône 24°

Femmina 45° compatta Metrica sede 24°



DN	TUBO PIPE	SERIE SERIES	ROSCA THREAD	Referencia Part n°
1/4"	8	L	M14x1,5	87306140804
3/8"	10	L	M16x1,5	87306161006
3/8"	12	L	M18x1,5	87306181206
1/2"	15	L	M22x1,5	87306221508
3/4"	22	L	M30x2	87306302212
1"	28	L	M36x2	87306362816
1/4"	8	S	M16x1,5	87306160804
1/4"	10	S	M18x1,5	87306181004
3/8"	12	S	M20x1,5	87306201206
1/2"	16	S	M24x1,5	87306241608
3/4"	25	S	M36x2	87306362512
1"	30	S	M42x2	87306423016

CRIMPING FITTINGS FOR HOSES

PIPE FITTINGS

PIPE FITTINGS II

ADAPTORS

WELDING FITTINGS

INDUSTRIAL FITTINGS

ACCESSORIES

CONTROL COMPONENTS

FLOW MEASURING

TRAILER LOK

Conexiones una sola pieza R7/ R8/ Elastómero malla metálica

One piece fittings R7/R8 & Elastomer Braid of steel wire
Embouts pré-sertis R7/R8 et Elastomère tresse métallique
Raccordi compatti serie R7/R8 e elastomero treccia metallica

Hembras giratorias rectas una sola pieza BSP (60°) doble hex

One piece double hexagonal BSP female 60° cone

Femelle pré-sertie BSP cône 60° double hexagonal

Femmina diritta compatta BSP sede 60° doppio esagono



DN	ROSCA THREAD	Referencia Part n°
1/4"	1/4" BSP	874000404
3/8"	3/8" BSP	874000606
1/2"	1/2" BSP	874000808
3/4"	3/4" BSP	874001212
1"	1" BSP	874001616

Hembras giratorias rectas una sola pieza rosca BSP cono 60°

One piece BSP female 60° cone

Femelle pré-sertie BSP cône 60°

Femmina diritta compatta BSP sede 60°



DN	ROSCA THREAD	Referencia Part n°
3/16"	1/4" BSP	871000403
1/4"	1/4" BSP	871000404
3/8"	3/8" BSP	871000606
1/2"	1/2" BSP	871000808
3/4"	3/4" BSP	871001212
1"	1" BSP	871001616

Hembras giratorias 90° una sola pieza rosca BSP co

One piece BSP female 60° cone (90° Elbow)

90° Femelle pré-sertie BSP cône 60°

Femmina 90° compatta BSP sede 60°



DN	ROSCA THREAD	Referencia Part n°
3/16"	1/4" BSP	NEW 871070403
1/4"	1/4" BSP	871070404
1/4"	3/8" BSP	871070604
3/8"	3/8" BSP	871070606
1/2"	1/2" BSP	871070808
3/4"	3/4" BSP	871071212
1"	1" BSP	871071616

Hembras giratorias 45° una sola pieza rosca BSP cono

One piece BSP female 60° cone (45° Elbow)

45° Femelle pré-sertie BSP cône 60°

Femmina 45° compatta BSP sede 60°



DN	ROSCA THREAD	Referencia Part n°
3/16"	1/4" BSP	NEW 871080403
1/4"	1/4" BSP	871080404
3/8"	3/8" BSP	871080606
1/2"	1/2" BSP	871080808
3/4"	3/4" BSP	871081212
1"	1" BSP	871081616

Machos una sola pieza rosca cilíndrica BSP cono 60°

One piece BSP male 60° cone

Mâle pré-serti BSP cône 60°

Maschio compatto cilindrico BSP sede 60°



DN	ROSCA THREAD	Referencia Part n°
1/4"	1/4" BSP	871120404
3/8"	3/8" BSP	871120606
1/2"	1/2" BSP	871120808
3/4"	3/4" BSP	871121212
1"	1" BSP	871121616

Conexiones una sola pieza PTFE Liso / R14

One piece fittings for Smooth PTFE/ R14
 Embouts pré-sertis pour PTFE lisse/ R14
 Raccordi compatti per PTFE liscio/ R14

Hembras gir rectas una sola pieza rosca JIC 37º doble hex

One piece JIC 37º double hexagonal female

Femelle pré-sertie JIC 37º double hexagonal

Femmina diritta JIC 37º doppio esagono



DN	ROSCA THREAD	Referencia Part nº
3/16"	7/16" 20h UNF	862420703
1/4"	7/16" 20h UNF	862420704
5/16"	7/16" 20h UNF	NEW 862420705
1/4"	1/2" 20h UNF	862420804
5/16"	1/2" 20h UNF	862420805
5/16"	9/16" 18h UNF	862420905
3/8"	9/16" 18h UNF	862420906
3/8"	3/4" 16h UNF	862421206
1/2"	3/4" 16h UNF	862421208
5/8"	3/4" 16h UNF	862421210
1/2"	3/4" 16h UNF	862421408
5/8"	3/4" 16h UNF	862421410
1/2"	1"1/16 12h UN	862421708
5/8"	1"1/16 12h UN	862421710
3/4"	1"1/16 12h UN	862421712
1"	1"1/16 12h UN	862421716
3/4"	1"5/16 12h UN	862422112
1"	1"5/16 12h UN	862422116

Hembras giratorias 90º una sola pieza rosca JIC 37º

One piece JIC 37º female (90º Elbow)

90º Femelle pré-sertie JIC 37º

Femmina 90º compatta JIC 37º



DN	ROSCA THREAD	Referencia Part nº
3/16"	7/16" 20h UNF	861380703
1/4"	7/16" 20h UNF	861380704
5/16"	9/16" 18h UNF	861380905
3/8"	9/16" 18h UNF	861380906
1/2"	3/4" 16h UNF	861381208
1/2"	7/8" 14UNF	861381408
5/8"	7/8" 14UNF	861381410
3/4"	1"1/16 12h UN	861381712
1"	1"5/16 12h UN	861382116

Machos una sola pieza rosca JIC 37º

One piece JIC 37º male

Mâle pré-serti JIC 37º

Maschio compatto JIC sede 37º



DN	ROSCA THREAD	Referencia Part nº
1/4"	7/16" 20h UNF	861400704
3/8"	9/16" 18h UNF	861400906
1/2"	3/4" 16h UNF	861401208
5/8"	1"1/16 12h UN	861401710
3/4"	1"1/16 12h UN	861401712
1"	1"5/16 12h UN	861402116

Hembras giratorias rectas una sola pieza rosca JIC 37º

One piece JIC 37º female

Femelle pré-sertie JIC 37º

Femmina diritta compatta JIC 37º



DN	ROSCA THREAD	Referencia Part nº
1/4"	7/16" 20h UNF	861420704
3/16"	7/16" 20h UNF	861420703
1/4"	1/2" 20h UNF	861420804
5/16"	1/2" 20h UNF	861420805
5/16"	9/16" 18h UNF	861420905
3/8"	9/16" 18h UNF	861420906
3/8"	3/4" 16h UNF	861421206
1/2"	3/4" 16h UNF	861421208
3/4"	1"1/16 12h UN	861421712
1"	1"5/16 12h UN	861422116

Hembras giratorias 45º una sola pieza rosca JIC 37º

One piece JIC 37º female (45º Elbow)

45º Femelle pré-sertie JIC 37º

Femmina 45º compatta JIC 37º



DN	ROSCA THREAD	Referencia Part nº
1/4"	7/16" 20h UNF	861390704
5/16"	9/16" 18h UNF	861390905
3/8"	9/16" 18h UNF	861390906
1/2"	3/4" 16h UNF	861391208
1/2"	7/8" 14h UNF	861391408
5/8"	7/8" 14h UNF	861391410
3/4"	1"1/16 12h UN	861391712
1"	1"5/16 12h UN	861392116

CRIMPING FITTINGS
FOR HOSES

PIPE
FITTINGS

PIPE
FITTINGS II

ADAPTORS

WELDING
FITTINGS

INDUSTRIAL
FITTINGS

ACCESSORIES

CONTROL
COMPONENTS

FLOW
MEASURING

TRALE LOK

CRIMPING FITTINGS FOR HOSES
 PIPE FITTINGS
 PIPE FITTINGS II
 ADAPTORS
 WELDING FITTINGS
 INDUSTRIAL FITTINGS
 ACCESSORIES
 CONTROL COMPONENTS
 FLOW MEASURING
 TRALE LOK

Conexiones una sola pieza PTFE Liso / R14

One piece fittings for Smooth PTFE/ R14

Embouts pré-sertis pour PTFE lisse/ R14

Raccordi compatti per PTFE liscio/ R14

Hembras giratorias rectas una sola pieza rosca ORFS doble hex

One piece double hexagonal ORFS female

Femelle pré-sertie ORFS double hexagonal

Femmina diritta compatta ORFS



DN	ROSCA THREAD	Referencia Part n°
1/4"	9/16"-18h	869000904
5/16"	11/16"-16h	869001105
3/8"	11/16"-16h	869001106
1/2"	13/16"-16h	869001308
3/4"	1"3/16-12h	869001912
1"	1"7/16-12h	869002316

Hembras giratorias 90º una sola pieza rosca ORFS

One piece ORFS female (90° Elbow)

90° Femelle pré-sertie ORFS

Femmina 90° compatta ORFS



DN	ROSCA THREAD	Referencia Part n°
1/4"	9/16"-18h	869070904
3/8"	11/16"-16h	869071106
1/2"	13/16"-16h	869071308
5/8"	1" 14 UNS	NEW 869071610
3/4"	1"3/16-12h	869071912
1"	1"7/16-12h	869072316

Machos una sola pieza rosca ORFS

One piece ORFS male

Mâle pré-serti ORFS

Maschio compatto ORFS



DN	ROSCA THREAD	Referencia Part n°
1/4"	9/16"-18h	869120904
3/8"	11/16"-16h	869121106
1/2"	13/16"-16h	869121308
3/4"	1"3/16-12h	869121912
1"	1"7/16-12h	869122316

Hembras giratorias 45º una sola pieza rosca ORFS

One piece ORFS female (45° Elbow)

45° Femelle pré-sertie ORFS

Femmina 45° compatta ORFS



DN	ROSCA THREAD	Referencia Part n°
1/4"	9/16"-18h	869080904
3/8"	11/16"-16h	869081106
1/2"	13/16"-16h	869081308
3/4"	1"3/16-12h	869081912
1"	1"7/16-12h	869082316

Conexiones una sola pieza PTFE Liso / R14

One piece fittings for Smooth PTFE / R14
 Embouts pré-sertis pour PTFE lisse / R14
 Raccordi compatti per PTFE liscio / R14

Hembras giratorias rectas una sola pieza NPSM (60°) doble hex

One piece double hexagonal NPSM female 60° cone

Femelle pré-sertie NPSM cône 60° double hexagonal

Femmina diritta compatta NPSM sede 60° doppio esagono



DN	ROSCA THREAD	Referencia Part n°
1/4"	1/4" NPSM	863610404
3/8"	3/8" 18h NPSM	863610606
1/2"	1/2" 14h NPSM	863610808
3/4"	3/4" NPSM	863611212
1"	1" - 11 1/2 h NPSM	863611616

Hembras giratorias 90° una sola pieza rosca NPSM

One piece NPSM female 60° cone (90° Elbow)

90° Femelle pré-sertie NPSM cône 60°

Femmina 90° compatta NPSM sede 60°



DN	ROSCA THREAD	Referencia Part n°
1/4"	1/4" 18h NPSM	862620404
3/8"	3/8" 18h NPSM	862620606
1/2"	1/2" 14h NPSM	862620808
3/4"	3/4" 14h NPSM	862621212
1"	1" - 11 1/2 h NPSM	862621616

Machos una sola pieza rosca cónica NPT

One piece NPT male pipe

Mâle pré-serti NPT

Maschio compatto conico NPT



DN	ROSCA THREAD	Referencia Part n°
1/4"	1/8" NPT	861610204
3/16"	1/4" NPT	861610403
1/4"	1/4" NPT	861610404
5/16"	1/4" NPT	861610405
3/8"	1/4" NPT	861610406
1/4"	3/8" NPT	861610604
5/16"	3/8" NPT	861610605
3/8"	3/8" NPT	861610606
1/2"	1/2" NPT	861610608
3/8"	1/2" NPT	861610806
1/2"	1/2" NPT	861610808
5/8"	1/2" NPT	861610810
1/2"	3/4" NPT	861611208
5/8"	3/4" NPT	861611210
3/4"	3/4" NPT	861611212
3/4"	1" NPT	861611612
1"	1" NPT	861611616
1"	1" 1/4 NPT	861612016

Hembras giratorias rectas una sola pieza rosca NPSM cono 60°

One piece NPSM female 60° cone

Femelle pré-sertie NPSM cône 60°

Femmina diritta compatta NPSM sede 60°



DN	ROSCA THREAD	Referencia Part n°
1/4"	1/4" 18h NPSM	862610404
3/8"	3/8" 18h NPSM	862610606
1/2"	1/2" 14h NPSM	862610808
3/4"	3/4" 14h NPSM	862611212
1"	1" - 11 1/2 h NPSM	862611616

Hembras giratorias 45° una sola pieza rosca NPSM cono

One piece NPSM female 60° cone (45° Elbow)

45° Femelle pré-sertie NPSM cône 60°

Femmina 45° compatta NPSM sede 60°



DN	ROSCA THREAD	Referencia Part n°
1/4"	1/4" 18h NPSM	862630404
3/8"	3/8" 18h NPSM	862630606
1/2"	1/2" 14h NPSM	862630808
3/4"	3/4" 14h NPSM	862631212
1"	1" - 11 1/2 h NPSM	862631616

Conexiones una sola pieza PTFE Liso / R14

One piece fittings for Smooth PTFE/ R14

Embouts pré-sertis pour PTFE lisse/ R14

Raccordi compatti per PTFE liscio/ R14

Hembras gir DKO rectas una sola pieza rosca Métrica 24°

One piece Metric female 24° cone

Femelle pré-sertie Métrique cône 24°

Femmina diritta compatta Metrica sede 24°



DN	TUBO PIPE	SERIE SERIES	ROSCA THREAD	Referencia Part n°
1/4"	8	L	M14x1.5	86804140804
3/8"	12	L	M18x1.5	86804181206
1/2"	12	L	M18x1.5	86804181208
1/2"	15	L	M22x1.5	86804221508
3/4"	18	L	M26x1.5	86804261812
3/4"	22	L	M30x2	86804302212
1"	28	L	M36x2	86804362816
1/4"	8	S	M16x1.5	86804160804
3/8"	12	S	M20x1.5	86804201206
1/2"	16	S	M24x1.5	86804241608
3/4"	25	S	M36x2	86804362512
1"	30	S	M42x2	86804423016

Hembras gir DKO90° una sola pieza rosca Métrica 24°

One piece Metric female 24° cone (90° Elbow)

90° Femelle pré-sertie Métrique cône 24°

Femmina 90° compatta Metrica sede 24°



DN	TUBO PIPE	SERIE SERIES	ROSCA THREAD	Referencia Part n°
1/4"	8	L	M14x1.5	86305140804
3/8"	12	L	M18x1.5	86305181206
1/2"	15	L	M22x1.5	86305221508
3/4"	22	L	M30x2	86305302212
1"	28	L	M36x2	86305362816
1/4"	8	S	M16x1.5	86305160804
3/8"	12	S	M20x1.5	86305201206
1/2"	16	S	M24x1.5	86305241608
3/4"	25	S	M36x2	86305362512
1"	30	S	M42x2	86305423016

Machos compactos rosca Métrica cono 24°

One piece Metric male 24° cone

Mâle pré-serti Métrique cône 24°

Maschio compatto Metrico sede 24°



DN	TUBO PIPE	SERIE SERIES	ROSCA THREAD	Referencia Part n°
1/4"	8	L	M14x1.5	86203140804
3/8"	12	L	M18x1.5	86203181206
1/2"	15	L	M22x1.5	86203221508
3/4"	22	L	M30x2	86203302212
1"	28	L	M36x2	86203362816
1/4"	8	S	M16x1.5	86203160804
3/8"	12	S	M20x1.5	86203201206
1/2"	16	S	M24x1.5	86203241608
3/4"	25	S	M36x2	86203362512
1"	30	S	M42x2	86203423016

Hembras gir DKO45° una sola pieza rosca Métrica 24°

One piece Metric female 24° cone (45° Elbow)

45° Femelle pré-sertie Métrique cône 24°

Femmina 45° compatta Metrica sede 24°



DN	TUBO PIPE	ROSCA THREAD	SERIE SERIES	Referencia Part n°
1/4"	8	M14x1.5	L	86306140804
3/8"	12	M18x1.5	L	86306181206
1/2"	15	M22x1.5	L	86306221508
3/4"	22	M30x2	L	86306302212
1"	28	M36x2	L	86306362816
1/4"	8	M16x1.5	S	86306160804
3/8"	12	M20x1.5	S	86306201206
1/2"	16	M24x1.5	S	86306241608
3/4"	25	M36x2	S	86306362512
1"	30	M42x2	S	86306423016

Conexiones una sola pieza PTFE Liso / R14

One piece fittings for Smooth PTFE/ R14

Embouts pré-sertis pour PTFE lisse/ R14

Raccordi compatti per PTFE liscio/ R14

Hembras giratorias rectas una sola pieza BSP (60°) doble hex

One piece double hexagonal BSP female 60° cone

Femelle pré-sertie BSP cône 60° double hexagonal

Femmina diritta compatta BSP sede 60° doppio esagono



DN	ROSCA THREAD	Referencia Part n°
1/4"	1/4" BSP	864000404
3/8"	3/8" BSP	864000606
1/2"	1/2" BSP	864000808
3/4"	3/4" BSP	864001212
1"	1" BSP	864001616

Hembras giratorias 90° una sola pieza rosca BSP con

One piece BSP female 60° cone (90° Elbow)

90° Femelle pré-sertie BSP cône 60°

Femmina 90° compatta BSP sede 60°



DN	ROSCA THREAD	Referencia Part n°
1/4"	1/4" BSP	861070404
3/8"	3/8" BSP	861070606
1/2"	1/2" BSP	861070808
1/2"	3/4" BSP NEW	861071208
3/4"	3/4" BSP	861071212
1"	1" BSP	861071616

Machos una sola pieza rosca cilíndrica BSP cono 60°

One piece BSP male 60° cone

Mâle pré-serti BSP cône 60°

Maschio compatto cilindrico BSP sede 60°



DN	ROSCA THREAD	Referencia Part n°
1/4"	1/4" BSP	861120404
3/8"	3/8" BSP	861120606
1/2"	1/2" BSP	861120808
3/4"	3/4" BSP	861121212
1"	1" BSP	861121616

Hembras giratorias rectas una sola pieza rosca BSP cono 60°

One piece BSP female 60° cone

Femelle pré-sertie BSP cône 60°

Femmina diritta compatta BSP sede 60°



DN	ROSCA THREAD	Referencia Part n°
3/16"	1/4" BSP	861000403
1/4"	1/4" BSP	861000404
3/8"	3/8" BSP	861000606
1/2"	1/2" BSP	861000808
3/4"	3/4" BSP	861001212
1"	1" BSP	861001616

Hembras giratorias 45° una sola pieza rosca BSP con

One piece BSP female 60° cone (45° Elbow)

45° Femelle pré-sertie BSP cône 60°

Femmina 45° compatta BSP sede 60°



DN	ROSCA THREAD	Referencia Part n°
1/4"	1/4" BSP	861080404
3/8"	3/8" BSP	861080606
1/2"	1/2" BSP	861080808
3/4"	3/4" BSP	861081212
1"	1" BSP	861081616

Espiga lisa una sola pieza recta gas

One piece gas standpipe

Embout pré-serti lisse droit gas

Estremità tubolare diritta gas



TUBO PIPE	DN	Referencia Part n°
6,4	1/4"	861590604
9,5	3/8"	861590906
12,7	3/8"	861591206
12,7	1/2"	861591208
15,8	5/8"	861591510
19,05	3/4"	NEW 861591912
25,4	1"	NEW 861592516

Conexiones una sola pieza PTFE Corrugado

One piece fittings for convoluted PTFE
Embouts pré-sertis pour PTFE convoluté
Raccordi compatti per PTFE corrugato

Hembras giratorias rectas una sola pieza rosca JIC 37º doble hex

One piece JIC 37º double hexagonal female

Femelle pré-sertie JIC 37º double hexagonal

Femmina diritta compatta JIC 37º doppio esagono



DN	ROSCA THREAD	Referencia Part nº
1/4"	7/16" 20h UNF	852420704
3/8"	1/2" 20 UNF	852420806
3/8"	9/16" 18h UNF	852420906
1/2"	3/4" 16h UNF	852421208
1/2"	7/8" 14UNF	852421408
5/8"	7/8" 14UNF	852421410
5/8"	1"1/16 12 UN	852421710
3/4"	1"1/16 12h UN	852421712
1"	1"5/16 12h UN	852422116
1"1/4	1"5/8 12h UN	852422620
1"1/2	1"7/8 12h UN	852423024
2"	2"1/2 12h UN	852424032

Hembras giratorias 90º una sola pieza rosca JIC 37º

One piece JIC 37º female (90º Elbow)

90º Femelle pré-sertie JIC 37º

Femmina 90º compatta JIC 37º



DN	ROSCA THREAD	Referencia Part nº
1/4"	7/16" 20h UNF	851380704
3/8"	9/16" 18h UNF	851380906
1/2"	3/4" 16h UNF	851381208
3/4"	1"1/16 12h UN	851381712
1"	1"5/16 12h UN	851382116
1"1/4	1"5/8 12h UN	851382620
1"1/2	1"7/8 12h UN	851383024
2"	2"1/2 12h UN	851384032

Machos una sola pieza rosca JIC 37º

One piece JIC 37º male

Måle pré-serti JIC 37º

Maschio compatto JIC sede 37º



DN	ROSCA THREAD	Referencia Part nº
1/4"	7/16" 20h UNF	851400704
3/8"	9/16" 18h UNF	851400906
1/2"	3/4" 16h UNF	851401208
5/8"	1"1/16 12h UN	851401710
3/4"	1"1/16 12h UN	851401712
1"	1"5/16 12h UN	851402116
1"1/4	1"5/8 12h UN	851402620
1"1/2	1"7/8 12h UN	851403024
2"	2"1/2 12h UN	851404032

Hembras giratorias rectas una sola pieza rosca JIC 37º

One piece JIC 37º female

Femelle pré-sertie JIC 37º

Femmina diritta compatta JIC 37º



DN	ROSCA THREAD	Referencia Part nº
1/4"	7/16" 20h UNF	851420704
5/16"	1/2" 20h UNF	851420805
3/8"	9/16" 18h UNF	851420906
1/2"	3/4" 16h UNF	851421208
3/4"	1"1/16 12h UN	851421712
1"	1"5/16 12h UN	851422116
1"1/4	1"5/8 12h UN	851422620
1"1/2	1"7/8 12h UN	851423024
2"	2"1/2 12h UN	851424032

Hembras giratorias 45º una sola pieza rosca JIC 37º

One piece JIC 37º female (45º Elbow)

45º Femelle pré-sertie JIC 37º

Femmina 45º compatta JIC 37º



DN	ROSCA THREAD	Referencia Part nº
1/4"	7/16" 20h UNF	851390704
3/8"	9/16" 18h UNF	851390906
1/2"	3/4" 16h UNF	851391208
3/4"	1"1/16 12h UN	851391712
1"	1"5/16 12h UN	851392116
1"1/4	1"5/8 12h UN	851392620
1"1/2	1"7/8 12h UN	851393024
2"	2"1/2 12h UN	851394032

Conexiones una sola pieza PTFE Corrugado

One piece fittings for convoluted PTFE
 Embouts pré-sertis pour PTFE convoluté
 Raccordi compatti per PTFE corrugato

Hembras giratorias rectas una sola pieza rosca ORFS doble hex

One piece doble hexagonal ORFS female

Femelle pré-sertie ORFS double hexagonal

Femmina diritta compatta ORFS



DN	ROSCA THREAD	Referencia Part n°
1/4"	9/16"-18h	859000904
3/8"	11/16"-16h	859001106
1/2"	13/16"-16h	859001308
3/4"	1"3/16-12h	859001912
1"	1"7/16-12h	859002316
1"1/4	1"11/16-16h	859002720
1"1/2	2" 12h	859003224

Hembras giratorias 90º una sola pieza rosca ORFS

One piece ORFS female (90° Elbow)

90° Femelle pré-sertie ORFS

Femmina 90° compatta ORFS



DN	ROSCA THREAD	Referencia Part n°
1/4"	9/16"-18h	859070904
3/8"	11/16"-16h	859071106
1/2"	13/16"-16h	859071308
3/4"	1"3/16-12h	859071912
1"	1"7/16-12h	859072316
1"1/4	1"11/16-16h	859072720
1"1/2	2" 12h	859073224

Machos una sola pieza rosca ORFS

One piece ORFS male

Mâle pré-serti ORFS

Maschio compatto ORFS



DN	ROSCA THREAD	Referencia Part n°
1/4"	9/16"-18h	859120904
3/8"	11/16"-16h	859121106
1/2"	13/16"-16h	859121308
3/4"	1"3/16-12h	859121912
1"	1"7/16-12h	859122316
1"1/4	1"11/16 12h	859122720
1"1/2	2" 12h	859123224

Hembras giratorias 45º una sola pieza rosca ORFS

One piece ORFS female (45° Elbow)

45° Femelle pré-sertie ORFS

Femmina 45° compatta ORFS



DN	ROSCA THREAD	Referencia Part n°
1/4"	9/16"-18h	859080904
3/8"	11/16"-16h	859081106
1/2"	13/16"-16h	859081308
3/4"	1"3/16-12h	859081912
1"	1"7/16-12h	859082316
1"1/4	1"11/16-16h	859082720
1"1/2	2" 12h	859083224

CRIMPING FITTINGS
FOR HOSES

PIPE
FITTINGS

PIPE
FITTINGS II

ADAPTORS

WELDING
FITTINGS

INDUSTRIAL
FITTINGS

ACCESSORIES

CONTROL
COMPONENTS

FLOW
MEASURING

TRALE LOK

Conexiones una sola pieza PTFE Corrugado

One piece fittings for convoluted PTFE
Embouts pré-sertis pour PTFE convoluté
Raccordi compatti per PTFE corrugato

Hembras gir rectas una sola pieza NPSM (60°) doble hex

One piece double hexagonal NPSM female 60° cone

Femelle pré-sertie NPSM cône 60° double hexagonal

Femmina diritta compatta NPSM sede 60° doppio esagono



DN	ROSCA THREAD	Referencia Part n°
1/4"	1/4" NPSM	853610404
3/8"	3/8" 18h NPSM	853610606
1/2"	1/2" 14h NPSM	853610808
3/4"	3/4" NPSM	853611212
1"	1" - 11 1/2 h NPSM	853611616

Hembras giratorias rectas una sola pieza rosca NPSM cono 60°

One piece NPSM female 60° cone

Femelle pré-sertie NPSM cône 60°

Femmina diritta compatta NPSM sede 60°



DN	ROSCA THREAD	Referencia Part n°
1/4"	1/4" 18h NPSM	852610404
3/8"	3/8" 18h NPSM	852610606
1/2"	1/2" 14h NPSM	852610808
3/4"	3/4" 14h NPSM	852611212
1"	1" - 11 1/2 h NPSM	852611616

Hembras giratorias 90° una sola pieza rosca NPSM

One piece NPSM female 60° cone (90° Elbow)

90° Femelle pré-sertie NPSM cône 60°

Femmina 90° compatta NPSM sede 60°



DN	ROSCA THREAD	Referencia Part n°
1/4"	1/4" 18h NPSM	852620404
3/8"	3/8" 18h NPSM	852620606
1/2"	1/2" 14h NPSM	852620808
3/4"	3/4" 14h NPSM	852621212
1"	1" - 11 1/2 h NPSM	852621616

Hembras giratorias 45° una sola pieza rosca NPSM con

One piece NPSM female 60° cone (45° Elbow)

45° Femelle pré-sertie NPSM cône 60°

Femmina 45° compatta NPSM sede 60°



DN	ROSCA THREAD	Referencia Part n°
1/4"	1/4" 18h NPSM	852630404
3/8"	3/8" 18h NPSM	852630606
1/2"	1/2" 14h NPSM	852630808
3/4"	3/4" 14h NPSM	852631212
1"	1" - 11 1/2 h NPSM	852631616

Machos una sola pieza rosca cónica NPT

One piece NPT male pipe straight

Mâle pré-serti NPT

Maschio compatto conico NPT



DN	ROSCA THREAD	Referencia Part n°
1/4"	1/8" NPT	851610204
1/4"	1/4" NPT	851610404
5/16"	1/4" NPT	851610405
3/8"	1/4" NPT	851610406
1/4"	3/8" NPT	851610604
5/16"	3/8" NPT	851610605
3/8"	3/8" NPT	851610606
1/2"	3/8" NPT	851610608
3/8"	1/2" NPT	851610806
1/2"	1/2" NPT	851610808
5/8"	1/2" NPT	851610810
1/2"	3/4" NPT	851611208
5/8"	3/4" NPT	851611210
3/4"	3/4" NPT	851611212
3/4"	1" NPT	851611612
1"	1" NPT	851611616
1"	1"1/4 NPT	851612016
1"1/4"	1"1/4 NPT	851612020
1"1/2"	1"1/2 NPT	851612424
2"	2" NPT	851613232

Conexiones una sola pieza PTFE Corrugado

One piece fittings for convoluted PTFE
 Embouts pré-sertis pour PTFE convoluté
 Raccordi compatti per PTFE corrugato

Hembras gir DKO rectas una sola pieza rosca Métrica cono 24°

One piece Metric female 24° cone

Femelle pré-sertie Métrique cône 24°

Femmina diritta compatta Metrica sede 24°



DN	TUBO PIPE	SERIE SERIES	ROSCA THREAD	Referencia Part n°
1/4"	8	L	M14x1.5	85804140804
3/8"	12	L	M18x1.5	85804181206
1/2"	15	L	M22x1.5	85804221508
3/4"	22	L	M30x2	85804302212
1"	28	L	M36x2	85804362816
1"1/4	35	L	M45x2	85804453520
1"1/2	42	L	M52x2	85804524224
1/4"	8	S	M16x1.5	85804160804
3/8"	12	S	M20x1.5	85804201206
1/2"	16	S	M24x1.5	85804241608
3/4"	25	S	M36x2	85804362512
1"	30	S	M42x2	85804423016
1"1/4	38	S	M52x2	85804523820

Machos una sola pieza rosca Métrica cono 24°

One piece Metric male 24° cone

Mâle pré-serti Métrique cône 24°

Maschio compatto Metrico sede 24°



DN	TUBO PIPE	SERIE SERIES	ROSCA THREAD	Referencia Part n°
1/4"	8	L	M14x1.5	85203140804
3/8"	12	L	M18x1.5	85203181206
1/2"	15	L	M22x1.5	85203221508
3/4"	22	L	M30x2	85203302212
1"	28	L	M36x2	85203362816
1"1/4	35	L	M45x2	85203453520
1"1/2	42	L	M52x2	85203524224
1/4"	8	S	M16x1.5	85203160804
3/8"	12	S	M20x1.5	85203201206
1/2"	16	S	M24x1.5	85203241608
3/4"	25	S	M36x2	85203362512
1"	30	S	M42x2	85203423016
1"1/4	38	S	M52x2	85203523820

Hembras gir DKO 90° una sola pieza rosca Métrica cono

One piece Metric female 24° cone (90° Elbow)

90° Femelle pré-sertie Métrique cône 24°

Femmina 90° compatta Metrica sede 24°



DN	TUBO PIPE	ROSCA THREAD	SERIE SERIES	Referencia Part n°
1/4"	8	M14x1.5	L	85305140804
3/8"	12	M18x1.5	L	85305181206
1/2"	15	M22x1.5	L	85305221508
3/4"	22	M30x2	L	85305302212
1"	28	M36x2	L	85305362816
1"1/4	35	M45x2	L	85305453520
1"1/2	42	M52x2	L	85305524224
1/4"	8	M16x1.5	S	85305160804
3/8"	12	M20x1.5	S	85305201206
1/2"	16	M24x1.5	S	85305241608
3/4"	25	M36x2	S	85305362512
1"	30	M42x2	S	85305423016
1"1/4	38	M52x2	S	85305523820

Hembras gir DKO 45° una sola pieza rosca Métrica cono 2

One piece Metric female 24° cone (45° Elbow)

45° Femelle pré-sertie Métrique cône 24°

Femmina 45° compatta Metrica sede 24°



DN	TUBO PIPE	SERIE SERIES	ROSCA THREAD	Referencia Part n°
1/4"	8	L	M14x1.5	85306140804
3/8"	12	L	M18x1.5	85306181206
1/2"	15	L	M22x1.5	85306221508
3/4"	22	L	M30x2	85306302212
1"	28	L	M36x2	85306362816
1"1/4	35	L	M45x2	85306453520
1"1/2	42	L	M52x2	85306524224
1/4"	8	S	M10x1.5	85306160804
3/8"	12	S	M20x1.5	85306201206
1/2"	16	S	M24x1.5	85306241608
3/4"	25	S	M36x2	85306362512
1"	30	S	M42x2	85306423016
1"1/4	38	S	M52x2	85306523820

Conexiones una sola pieza PTFE Corrugado

One piece fittings for convoluted PTFE
Embouts pré-sertis pour PTFE convoluté
Raccordi compatti per PTFE corrugato

Hembras giratorias rectas una sola pieza rosca BSP (60°) doble hex

One piece double hexagonal BSP female 60° cone

Femelle pré-sertie BSP cône 60° double hexagonal

Femmina diritta compatta BSP sede 60° doppio esagono



DN	ROSCA THREAD	Referencia Part n°
1/4"	1/4" BSP	854000404
3/8"	3/8" BSP	854000606
1/2"	1/2" BSP	854000808
3/4"	3/4" BSP	854001212
1"	1" BSP	854001616
1"1/4"	1"1/4 BSP	854002020
1"1/2"	1"1/2 BSP	854002424
2"	2" BSP	854003232

Hembras giratorias rectas una sola pieza rosca BSP cono 60°

One piece BSP female 60° cone

Femelle pré-sertie BSP cône 60°

Femmina diritta compatta BSP sede 60°



DN	ROSCA THREAD	Referencia Part n°
1/4"	1/4" BSP	851000404
3/8"	3/8" BSP	851000606
1/2"	1/2" BSP	851000808
3/4"	3/4" BSP	851001212
1"	1" BSP	851001616
1"1/4"	1"1/4 BSP	851002020
1"1/2"	1"1/2 BSP	851002424
2"	2" BSP	851003232

Hembras giratorias 90° una sola pieza rosca BSP cono

One piece BSP female 60° cone (90° Elbow)

90° Femelle pré-sertie BSP cône 60°

Femmina 90° compatta BSP sede 60°



DN	ROSCA THREAD	Referencia Part n°
1/4"	1/4" BSP	851070404
3/8"	3/8" BSP	851070606
1/2"	1/2" BSP	851070808
3/4"	3/4" BSP	851071212
1"	1" BSP	851071616
1"1/4"	1"1/4 BSP	851072020
1"1/2"	1"1/2 BSP	851072424
2"	2" BSP	851073232

Hembras giratorias 45° una sola pieza rosca BSP c

One piece BSP female 60° cone (45° Elbow)

45° Femelle pré-sertie BSP cône 60°

Femmina 45° compatta BSP sede 60°



DN	ROSCA THREAD	Referencia Part n°
1/4"	1/4" BSP	851080404
3/8"	3/8" BSP	851080606
1/2"	1/2" BSP	851080808
3/4"	3/4" BSP	851081212
1"	1" BSP	851081616
1"1/4"	1"1/4 BSP	851082020
1"1/2"	1"1/2 BSP	851082424
2"	2" BSP	851083232

Machos una sola pieza rosca cilíndrica BSP cono 60°

One piece BSP male 60° cone

Mâle pré-serti BSP cône 60°

Maschio compatto cilindrico BSP sede 60°



DN	ROSCA THREAD	Referencia Part n°
1/4"	1/4" BSP	851120404
3/8"	3/8" BSP	851120606
1/2"	1/2" BSP	851120808
3/4"	3/4" BSP	851121212
1"	1" BSP	851121616
1"1/4"	1"1/4 BSP	851122020
1"1/2"	1"1/2 BSP	851122424
2"	2" BSP	851123232

Conexiones Reusables

Reusable series
Embouts série récupérable
Serie Recuperabile

Hembras giratorias rectas una sola pieza R2T rosca JIC 37°

One Piece Swivel Female R2AT JIC 37°

Femelle tournante 1 pièce R2AT JIC 37°

Femmina compatta JIC 37° - R2AT



DN	ROSCA THREAD	Referencia Part n°
1/4"	7/16" 20h UNF	Z3J-07-04-R2T
3/8"	9/16" 18h UNF	Z3J-09-06-R2T
1/2"	3/4" 16h UNF	Z3J-12-08-R2T
1/2"	7/8" 14h UNF	Z3J-14-08-R2T
5/8"	7/8" 14h UNF	Z3J-14-10-R2T
3/4"	1" 1/16 12h UNF	Z3J-17-12-R2T
1"	1" 5/16 12h UNF	Z3J-21-16-R2T

Machos una sola pieza R2T rosca cónica NPT

One Piece Male R2AT NPT

Mâle 1 pièce 2AT NPT

Maschio compatto NPT - R2AT



DN	ROSCA THREAD	Referencia Part n°
1/4"	1/4" NPT	Z2NPT-04-04-R2T
3/8"	3/8" NPT	Z2NPT-06-06-R2T
1/2"	1/2" NPT	Z2NPT-08-08-R2T
3/4"	3/4" NPT	Z2NPT-12-12-R2T
1"	1" NPT	Z2NPT-16-16-R2T

Casquillos reus para manguera R1T/1SN no pelar

Reusable ferrules R1T/1SN non skive

Jupes récupérables R1T/1SN sans dénudage

Boccola recuperabile per R1T senza pelatura



DN	Referencia Part n°
1/4"	Z1G-4 R1T INOX
5/16"	Z1G-5 R1T INOX
3/8"	Z1G-6 R1T INOX
1/2"	Z1G-8 R1T INOX
3/4"	Z1G-12 R1T INOX
1"	Z1G-16 R1T INOX

Casquillos reus para manguera R2AT/2SN no pelar

Reusable ferrules R2AT/2SN non skive

Jupes récupérables R2AT/2SN sans dénudage

Boccola recuperabile per R2AT/2SN senza pelatura



DN	Referencia Part n°
1/4"	Z1G-4 R2T INOX
3/8"	Z1G-6 R2T INOX
1/2"	Z1G-8 R2T INOX
5/8"	Z1G-10 R2T INOX
3/4"	Z1G-12 R2T INOX
1"	Z1G-16 R2T INOX

Hembras giratorias rectas reusables rosca BSP cono 60°

Reusable BSP Swivel female 60° cone

Femelle récupérable gaz cylindrique 60°

Femmina diritta BSP sede 60° recuperabile



DN	ROSCA THREAD	Referencia Part n°
1/4"	1/4" BSP	Z3G-4
5/16"	3/8" BSP	Z3G-6-5
3/8"	3/8" BSP	Z3G-6
3/8"	1/2" BSP	Z3G-8-6
1/2"	1/2" BSP	Z3G-8
3/4"	3/4" BSP	Z3G-12
1"	1" BSP	Z3G-16
1" 1/4"	1" 1/4 BSP	Z3G-20
1" 1/2"	1" 1/2 BSP	Z3G-24*

* Hasta fin de existencias / Until end of stock / Jusqu'à la fin du stock / Fino ad esaurim

Hembras giratorias 90° reusables rosca BSP cono 6

Reusable BSP 60° cone (90° Elbow)

Coude 90° femelle récupérable gaz cylindrique BSP 60°

Femmina 90° BSP sede 60° recuperabile



DN	ROSCA THREAD	Referencia Part n°
1/4"	1/4" BSP	Z90G-4
3/8"	3/8" BSP	Z90G-6
3/8"	1/2" BSP	Z90G-8-6
1/2"	1/2" BSP	Z90G-8
3/4"	3/4" BSP	Z90G-12
1"	1" BSP	Z90G-16

Machos reusables rosca cilíndrica BSP cono 60°

Reusable BSP Male parallel 60° cone

Mâle récupérable gaz cylindrique BSP 60°

Maschio BSP cilindrico sede 60° recuperabile



DN	ROSCA THREAD	Referencia Part n°
1/4"	1/4" BSP	Z2G-4
3/8"	3/8" BSP	Z2G-6-5
3/8"	3/8" BSP	Z2G-6
3/8"	1/2" BSP	Z2G-8-6
1/2"	1/2" BSP	Z2G-8
3/4"	3/4" BSP	Z2G-12
1"	1" BSP	Z2G-16

Conexiones Reusables

Reusable series
Embouts série récupérable
Serie Recuperabile

Hembras giratorias rectas reusables rosca JIC cono 37°

Reusable JIC 37° straight Swivel female

Femelle droite récupérable JIC 37°

Femmina diritta JIC sede 37° recuperabile



DN	ROSCA THREAD	Referencia Part n°
1/4"	7/16" 20h UNF	Z3J-07-04
3/8"	9/16" 18h UNF	Z3J-09-06
1/2"	3/4" 16h UNF	Z3J-12-08
1/2"	7/8" 14h UNF	Z3J-14-08
5/8"	7/8" 14h UNF	Z3J-14-10
3/4"	1"1/16 12h UNF	Z3J-17-12
1"	1"5/16 12h UNF	Z3J-21-16

Machos reusables rosca JIC cono 37°

Reusable JIC Male 37° cone

Mâle récupérables JIC cône 37°

Maschio JIC 37° recuperabile



DN	ROSCA THREAD	Referencia Part n°
1/4"	7/16" 20h UNF	Z2J-07-04
3/8"	9/16" 18h UNF	Z2J-09-06
1/2"	3/4" 16h UNF	Z2J-12-08
1/2"	7/8" 14h UNF	Z2J-14-08
5/8"	7/8" 14h UNF	Z2J-14-10
3/4"	1"1/16 12h UNF	Z2J-17-12
1"	1"5/16 12h UNF	Z2J-21-16

Hembras giratorias 90° reusables rosca JIC cono 37°

90° reusable Swivel female thread JIC cone 37°

Femelle tournante 90° filetage récupérable cône JIC 37°

Femmina 90° JIC 37° recuperabile



DN	ROSCA THREAD	Referencia Part n°
1/4"	7/16" 20h UNF	Z3J90-07-04
3/8"	9/16" 18h UNF	Z3J90-09-06
1/2"	3/4" 16h UNF	Z3J90-12-08
1/2"	7/8" 14h UNF	Z3J90-14-08
5/8"	7/8" 14h UNF	Z3J90-14-10
3/4"	1"1/16 12h UN	Z3J90-17-12
1"	1"5/16 12h UN	Z3J90-21-16

Hembras giratorias 45° reusables rosca JIC cono 37°

45° reusable Swivel female thread JIC cone 37°

Femelle tournante 45° filetage récupérable cône JIC 37°

Femmina 45° JIC 37° recuperabile



DN	ROSCA THREAD	Referencia Part n°
1/4"	7/16" 20h UNF	Z3J45-07-04
3/8"	9/16" 18h UNF	Z3J45-09-06
1/8"	3/4" 16h UNF	Z3J45-12-08
1/2"	7/8" 14h UNF	Z3J45-14-08
5/8"	7/8" 14h UNF	Z3J45-14-10
3/4"	1"1/16 12h UN	Z3J45-17-12
1"	1"5/16 12h UN	Z3J45-21-16

Machos reusables rosca NPT

Reusable NPT Male

Mâle récupérable NPT

Maschio NPT recuperabile



DN	ROSCA THREAD	Referencia Part n°
1/4	1/4" NPT	Z2NPT-04-04
3/8	3/8" NPT	Z2NPT-06-06
1/2	1/2" NPT	Z2NPT-08-08
3/4	3/4" NPT	Z2NPT-12-12
1"	1" NPT	Z2NPT-16-16

Espigas lisas Métricas reusables

Reusable Metric standpipe

Embout lisse récupérable Métrique

Estremità tubolare recuperabile



DN	TUBO PIPE	Referencia Part n°
1/4"	6	ZE-6-4
1/4"	8	ZE-8-4
3/8"	8	ZE-8-6
1/4"	10	ZE-10-4
5/16"	10	ZE-10-5
3/8"	10	ZE-10-6
5/16"	12	ZE-12-5
3/8"	12	ZE-12-6
3/8"	15	ZE-15-6
1/2"	15	ZE-15-8
1/2"	16	ZE-16-8
3/4"	22	ZE-22-12
3/4"	25	ZE-25-12
1"	25	ZE-25-16
1"	28	ZE-28-16
1"	30	ZE-30-16

Conexiones Reusables

Reusable series
Embouts série récupérable
Serie Recuperabile

Hembras giratorias rectas reusables R5 rosca JIC cono 37º

Reusable R5 JIC 37º straight swivel female

Femelle pivotante droite réutilisable R5 JIC filetage 37º cône

Femmina diritta compatta recuperabile JIC 37º - R5



DN	ROSCA THREAD	Referencia Part nº
3/16"	7/16" 20 UNF	Z3J-07-04-R5
1/4"	7/16" 20h UNF	Z3J-07-05-R5
1/4"	1/2" 20h UNF	Z3J-08-05-R5
5/16"	1/2" 20h UNF	Z3J-08-06-R5
5/16"	9/16" 18h UNF	Z3J-09-06-R5
13/32"	3/4" 16h UNF	Z3J-12-08-R5
1/2"	3/4" 16h UNF	Z3J-12-10-R5
1/2"	7/8"x14 UNF	Z3J-14-10-R5
5/8"	1" 1/16" 12 UNF	Z3J-17-12-R5
7/8"	1" 5/16" 12 UNF	Z3J-21-16-R5
1"1/8	1" 5/8 12 UNF	Z3J-26-20-R5
1"3/8	1" 7/8 12 UNF	Z3J-30-24-R5
1"13/16	2" 1/2 12UNF	Z3J-40-32-R5

Hembras giratorias 90º reusables R5 rosca JIC cono 37º

Reusable R5 JIC 37º swivel female (90º elbow)

Femelle pivotante 90º filetage R5 réutilisable cône JIC 37º

Femmina 90º compatta recuperabile JIC 37º - R5



DN	ROSCA THREAD	Referencia Part nº
3/16"	7/16" 20 UNF	Z3J90-07-04-R5
1/4"	7/16" 20h UNF	Z3J90-07-05-R5
1/4"	1/2" 20h UNF	Z3J90-08-05-R5
5/16"	9/16" 18h UNF	Z3J90-09-06-R5
13/32"	3/4" 16h UNF	Z3J90-12-08-R5
1/2"	3/4" 16h UNF	Z3J90-12-10-R5
1/2"	7/8" 14 UNF	Z3J90-14-10-R5
5/8"	1" 1/16 12 UNF	Z3J90-17-12-R5
7/8"	1" 5/16" 12 UNF	Z3J90-21-16-R5

Machos reusables R5 rosca NPT

Reusable R5 NPT Male

Mâle récupérables R5 NPT

Maschio NPT recuperabile - R5



DN	ROSCA THREAD	Referencia Part nº
3/16"	1/4" NPT	Z2P-04-04-R5
1/4"	1/4" NPT	Z2P-04-05-R5
5/16"	3/8" NPT	Z2P-06-06-R5
13/32"	1/2" NPT	Z2P-08-08-R5
1/2"	1/2" NPT	Z2P-08-10-R5
5/8"	3/4" NPT	Z2P-12-12-R5
7/8"	1" NPT	Z2P-16-16-R5
1" 1/8	1" 1/4 NPT	Z2P-20-20-R5
1" 3/8	1" 1/2 NPT	Z2P-24-24-R5
1" 13/16	2" NPT	Z2P-32-32-R5

Hembras giratorias 45º reusables R5 rosca JIC cono 37º

Reusable R5 JIC 37º swivel female (45º elbow)

Femelle pivotante 45º réutilisable Filetage R5 cône JIC 37º

Femmina 45º compatta recuperabile JIC 37º - R5



DN	ROSCA THREAD	Referencia Part nº
3/16"	7/16" 20 UNF	Z3J45-07-04-R5
1/4"	7/16" 20h UNF	Z3J45-07-05-R5
1/4"	1/2" 20h UNF	Z3J45-08-05-R5
5/16"	9/16" 18h UNF	Z3J45-09-06-R5
13/32"	3/4" 16h UNF	Z3J45-12-08-R5
1/2"	3/4" 16h UNF	Z3J45-12-10-R5
1/2"	7/8" 14 UNF	Z3J45-14-10-R5
5/8"	1" 1/16 12 UNF	Z3J45-17-12-R5
7/8"	1" 5/16" 12 UNF	Z3J45-21-16-R5

■ CONEXIONES REUSABLES R5

■ REUSABLE R5 FITTINGS



Consulta datos en nuestra ficha técnica | Check our technical sheet for data

Sistemas hidráulicos de **media presión** con fluidos basados en petróleo o agua/glycol, aceites y lubricantes.

Medium pressure hydraulic systems with petroleum or water/glycol based fluids and for fuel and lubricating oils

Conexiones Push-On

Push-On Fittings
Embouts Push-On
Raccordi Serie Push-On

Hembras giratorias rectas rosca BSP cono 60°

BSP Swivel female 60° cone

Femelle tournante BSP cône 60°

Femmina diritta BSP sede 60° Push-On



DN	ROSCA THREAD	Referencia Part n°
1/4"	1/4" BSP	891000404
3/8"	3/8" BSP	891000606
1/2"	1/2" BSP	891000808
5/8"	5/8" BSP	891001010
3/4"	3/4" BSP	891001212
1"	1" BSP	891001616

Machos rosca cilíndrica BSP cono 60°

BSP Male 60° cone

Mâle fixe BSP cône 60°

Maschio cilindrico BSP sede 60° Push-On



DN	ROSCA THREAD	Referencia Part n°
1/4"	1/4" BSP	891120404
3/8"	3/8" BSP	891120606
1/2"	1/2" BSP	891120808
3/4"	1/2" BSP	891120812
5/8"	5/8" BSP	891121010
3/4"	3/4" BSP	891121212
1"	1" BSP	891121616

Hembras giratorias rectas JIC 37°

JIC 37° Swivel female

Femelle tournante JIC 37°

Femmina diritta JIC sede 37° Push-On



DN	ROSCA THREAD	Referencia Part n°
1/4"	7/16" 20h UNF	891420704
3/8"	9/16" 18h UNF	891420906
1/2"	3/4" 16h UNF	891421208
5/8"	7/8" 14h UNF	891421410
3/4"	1" 1/16 12h UN	891421712
1"	1" 5/16 12h UN	891422116

Machos rosca JIC cono 37°

JIC 37° Male

Mâle fixe JIC 37°

Maschio JIC sede 37° Push-On



DN	ROSCA THREAD	Referencia Part n°
1/4"	7/16" 20h UNF	891400704
3/8"	9/16" 18h UNF	891400906
1/2"	3/4" 16h UNF	891401208
5/8"	7/8" 14h UNF	891401410
3/4"	1" 1/16 12h UN	891401712
1"	1" 5/16 12h UN	891402116

Machos rosca cónica NPT

NPT Male pipe straight

Mâle gaz conique NPT (BRIGGS)

Maschio conico NPT Push-On



DN	ROSCA THREAD	Referencia Part n°
1/4"	1/4" NPT	891610404
3/8"	3/8" NPT	891610606
1/2"	1/2" NPT	891610808
3/4"	3/4" NPT	891611212
1"	1" NPT	891611616

Hembra giratoria recta Métrica cono 24°

Metric female swivel with o-ring 24° cone

Femelle Métrique avec o-ring cône 24°

Femmina metrica sede 24°+O-ring Push-On

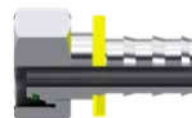

DN	TUBO PIPE	SERIE SERIES	ROSCA THREAD	Referencia Part n°
1/4"	6	L	M12x1,5	89804120604
1/4"	8	L	M14x1,5	89804140804
1/4"	10	L	M16x1,5	89804161004
3/8"	12	L	M18x1,5	89804181206
1/2"	15	L	M22x1,5	89804221508
3/4"	22	L	M30x2	89804302212

Machos rosca métrica cono 24°

Metric stud 24° cone

Mâle Métrique cône 24°

Maschio metrico sede 24° Push-On



DN	TUBO PIPE	SERIE SERIES	ROSCA THREAD	Referencia Part n°
1/4"	8	L	M14x1,5	89203140804
1/4"	10	L	M16x1,5	89203161004
3/8"	12	L	M18x1,5	89203181206
1/2"	15	L	M22x1,5	89203221508
3/4"	22	L	M30x2	89203302212

Conexiones Alta Presión (700 bar)

High pressure 700 bar fittings
Embouts haute pression 700 bar
Raccordi Altissima pressione (700 bar)

Casquillos para alta presión (700bar)

Ferrules for thermoplastic hose 700 bar

Jupes à sertir thermoplastique 700 bar

Boccole per tubo termoplastico 700 bar



DN	Referencia Part n°
1/4"	Z710120400
3/8"	Z710120600
1/2"	Z710120800

Hembra giratoria BSP cono 60° (700bar)

BSP Swivel female 60° cone 700 bar

Embout 700 bar femelle tournante gaz cyl BSP 60°

Femmina diritta BSP sede 60° 700 bar



DN	ROSCA THREAD	Referencia Part n°
1/4"	1/4" BSP	Z741000404
3/8"	3/8" BSP	Z741000606
1/2"	1/2" BSP	Z741000808

Macho BSP cono 60° (700bar)

BSP Male parallel 60° cone 700 bar

Embout 700 bar mâle fixe gaz cyl BSP 60°

Maschio cilindrico BSP sede 60° 700 bar



DN	ROSCA THREAD	Referencia Part n°
1/4"	1/4" BSP	Z741120404
3/8"	3/8" BSP	Z741120606
1/2"	1/2" BSP	Z741120808

Hembra giratoria NPSM cono 60° (700bar)

NPSM Swivel female 60° cone 700 bar

Embout 700 bar femelle tournante NPSM 60°

Femmina diritta NPSM sede 60° 700 bar



DN	ROSCA THREAD	Referencia Part n°
1/4"	1/4" 18h NPSM	Z742610404
3/8"	3/8" 18h NPSM	Z742610606
1/2"	1/2" 14h NPSM	Z742610808

Macho NPT (700bar)

NPT Male pipe straight 700 bar

Embout 700 bar mâle fixe gaz conique NPT

Maschio conico NPT 700 bar



DN	ROSCA THREAD	Referencia Part n°
1/4"	1/4" NPT	Z741610404
1/4"	3/8" NPT	Z741610604
3/8"	3/8" NPT	Z741610606
1/2"	1/2" NPT	Z741610808

Hembra giratoria JIC 37° (700bar)

JIC 37° Swivel female 700 bar

Embout 700 bar femelle tournante droit JIC 37°

Femmina JIC 37° 700 bar



DN	ROSCA THREAD	Referencia Part n°
1/4"	7/16" 20h UNF	Z741420704
1/4"	9/16" 18h UNF	Z741420904
3/8"	9/16" 18h UNF	Z741420906
1/2"	3/4" 16h UNF	Z741421208

Macho JIC 37° (700bar)

JIC 37° Male thread 700 bar

Embout 700 bar mâle fixe JIC 37°

Maschio JIC 37° 700 bar



DN	ROSCA THREAD	Referencia Part n°
1/4"	7/16" 20h UNF	Z741400704
3/8"	9/16" 18h UNF	Z741400906
1/2"	3/4" 16h UNF	Z741401208

Hembra giratoria Métrica 24° (700bar)

Metric Swivel female 24° cone 700 bar

Embout 700 bar femelle tournante droit Métrique cône 24°

Femmina diritta Metrica sede 24° 700 bar



DN	TUBO PIPE	SERIE SERIES	ROSCA THREAD	Referencia Part n°
1/4"	8	S	M16x1.5	Z74804160804
3/8"	12	S	M20x1.5	Z74804201206
1/2"	16	S	M24x1.5	Z74804241608

Macho Métrico 24° (700bar)

Metric Male 24° cone 700 bar

Embout 700 bar mâle fixe Métrique cône 24°

Maschio metrico sede 24° 700 bar



DN	TUBO PIPE	SERIE SERIES	ROSCA THREAD	Referencia Part n°
1/4"	8	S	M16x1.5	Z74203160804
3/8"	12	S	M20x1.5	Z74203201206
1/2"	16	S	M24x1.5	Z74203241608

CRIMPING MACHINES

Prensas
Pressen
Presses

TrAle®

MANGUERA HIDRÁULICA · HYDRAULIC HOSES

MANUALES · MANUAL

PM 18 6J N

80 T +20 mm
59 mm 28 kg.



TrAle®
1" 2SP
3/4" 4SP
1/2" 6SP

PM16-8J

100 T +20 mm
59 mm 25 kg.



TrAle®
1" 3SP

PM16 ELBOW-8J

100 T +20 mm
59 mm 25 kg.



TrAle®
1" 3SP



die set

PM16-SPEED-8J

100 T +20 mm
59 mm 25 kg.



TrAle®
1" 3SP

PM18F-9J

120 T +20 mm
65 mm 22 kg.



TrAle®
1" 4SP

PM22-9J

140 T +25 mm
110 mm 22 kg.



TrAle®
1" 1/4 4SP

PM22P-9J

140 T +20 mm
110 mm 55 kg.



TrAle®
1" 1/4 4SP

ELÉCTRICAS · ELECTRICAL

PE 28 9J NT

170 T
+26 mm
110 mm



TrAle®
1" 1/4 4SP

PE 38 15J NT

220 T
+32 mm
130 mm



TrAle®
2" 4SP
1" 6SP

PE 50 17J NT

420 T
+32 mm
130 mm



TrAle®
2" 6SP

Bajo pedido
Under Request



SE 28 5J N/10J N

137 T
+28 mm
100 mm



TrAle®
1" 1/4 4SP

PE 38 12 J N

240 T
+38 mm
118 mm



TrAle®
2" 4SP
1" 6SP

PE 58 14J N | PE 58 14J 5.5 N

350 T
+54 mm
180 mm



TrAle®
2" 6SP
3" 2SP



CUTTING MACHINES

Cortadoras
Schneidemaschinen und Zubehör
Trongommeuse et Accessoires

MANGUERA HIDRÁULICA · HYDRAULIC HOSES

ELÉCTRICAS · ELECTRICAL

CHMT-20 N

- Ø Max. 50mm
- 2,2 Kw
- Ø 250 mm



TrAle®
1"1/4 4SP

CHM4-32 N

- Ø Max. 75mm
- 3 Kw
- Ø 250 mm



TrAle®
2" 4SP

CHM4-32 N2

- Ø Max. 75mm
- 4 Kw
- Ø 300 mm



TrAle®
2" 4SH

CHM6-32 N

- Ø Max. 125mm
- 5,5 Kw
- Ø 520 mm

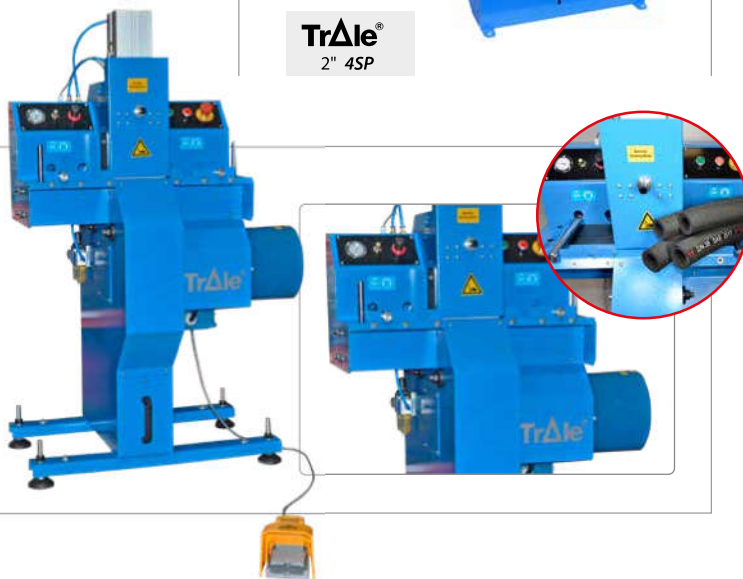

TrAle®
2" 6SP
2" IND



PORTARROLLOS, EXPOSITORES Y ENROLLADORES · REEL HOSE, ROLL HOLDERS AND EXHIBITORS

ROLLER



PRO7

Carga máx.
recomendada /
bandeja: 70 Kg.

Carga total
recomendada:
490 Kg.

Each holder max
70 kg

Total max.
capacity: 490 kg



PCM3

Carga máx. rollo: 35 Kg.

Each roll max 35 Kg.



ACCESORIOS PARA PRENSAS · ACCESSORIES FOR CRIMPING MACHINES

M PE 38 NT



SPEBD N



EGN | EGNT



PEDAL.N/NT



GARRAS ESPECIALES SPECIAL DIES



SKIVING MACHINES

Peladoras
Schälmaschinen
Dénudeuse

TrAle®

MANGUERA HIDRÁULICA · HYDRAULIC HOSES

PELADORA · SKIVING MACHINE

PB-32N



TrAle®
2"

Útiles / Tools



Portaherramientas.
Tool holder

PMT 2



Peladora Manual
Manual hose skiving

BANCO DE PRUEBAS · TEST BENCH

TB 2500





MACHINES FOR PROCESSING RIGID PIPES

Máquinas para tubo rígido
 Maschinen für tube
 Macchine pour tube

PIPE · TUBO RÍGIDO

DEBURRING MACHINE · DESBARBADORA

DEBUR01

R.P.M. 75 0.18 Kw Ø 6-42 mm 30 kg



Útiles de desbarbado incluidos
 Deburring tools included

ASSEMBLY MACHINE · MONTAJE

USFL/01 MAN

6 → 42 x 4 mm



DIN 2353 JIC 37°

TUBE2437

6 → 42 x 4 mm 0,75 Kw



DIN 2353 JIC 37°

BENDING MACHINES · DOBLADORAS

M18 6-18

6 → 18 mm



CMS42

6 → 42 x 4 mm



Con soporte
 With tool-holder cabinet.

BENDER642

6 → 42 x 4 mm

1.1 Kw

Dobladora eléctrica con mueble.
 Electric bending machine with cabinet



Bending & Assembly Machine Tools · Útiles para las máquinas de doblado y montaje de racores

CUC42



Matrices de doblado
 Bending tools

TOOLHOLDER37



FT37
 Matrices JIC 37°
 Tools JIC 37°

BL



Bloque BL JIC 37°
 BL Block JIC 37°

TOOLHOLDER24



Machos y matrices DIN 2353
 Sockets & plates DIN 2353

WORK BENCH · BANCOS DE TRABAJO

CEN-MINI

1.7 Kw max.

210 kg.

Mini
 Mini



Pequeño y económico
 Small & inexpensive

CEN-JU

Completo
 Complete

4.6 Kw max.

300 kg.

Max. Ø 100 mm.

220 l/min.
 AIR



Con corte & aire comprimido
 With cutting & compressed air



Tubo TrΔle® métrico | **104**

TrΔle® metric pipe
Tube rigide TrΔle® métrique
Tubo rigido TrΔle® metrico

Racores DIN 2353 | **105**

DIN 2353 Pipe fittings
Raccords à bague DIN 2353
Raccordi DIN 2353

Racores JIC 37° | **125**

Flare fittings JIC 37°
Adapteurs JIC 37°
Raccordi JIC 37°



02

|TUBO RÍGIDO TRALE®

Pipe fittings

Raccord tube rigide

Raccordi DIN2353 – JIC 37°



Tridale®



INSTRUCCIONES DE MONTAJE DE RACOR DIN 2353 SOBRE EL TUBO RÍGIDO (SE RECOMIENDA EL USO DE HERRAMIENTAS DE PREMONTAJE)
 ASSEMBLY OF THE PIPE FITTINGS DIN 2353 IN THE RIGID PIPE (IT IS RECOMMENDED TO USE PRE-ASSEMBLY TOOLS)

1 CORTE Y PREPARACIÓN DEL TUBO
 PIPE SAW & PREPARATION



- Fija el tubo a dispositivos rígidos
- Corta el tubo recto y sin rebabas (max. ± 1° de desviación)
- No utilice cortatubos
- Clamp onto rigid fixtures
- Cut tube squarely and deburr thoroughly (max. ± 1° deviation)
- Do not use pipe cutters

ALTURA MÍNIMA(H RECTA): DOS VECES LA LONGITUD DE LA TUERCA LONGITUD MÍNIMA(L): 2,5 - 3 VECES LA LONGITUD DE LA TUERCA

Series Ø ext. Pipe	LL				L								S											
	4	5	6	8	6	8	10	12	15	18	22	28	35	42	6	8	10	12	14	16	20	25	30	38
H min.	LL				L								S											
	24	25	25	26	31	31	33	33	36	38	42	42	48	48	35	35	37	37	43	43	50	54	58	65
L min.	LL				L								S											
	30	32	32	33	39	39	42	42	45	48	53	53	60	60	44	44	47	47	54	54	63	68	73	82



- Cortar el tubo a escuadra y eliminar rebabas.
- Rectangularly saw off the pipe and remove all burrs.



- Quita las rebabas interiores y exteriores
- Las rebabas grandes pueden dañar las juntas
- Remove internal and external burrs
- Seal can be damaged by large burrs

2 MONTAJE EN BANCO
 ASSEMBLY IN VICE



- Utiliza lubricantes específicos (GR ASW120)
- Lubricar las roscas de los racores inox adecuadamente.
- Use properly lubricants (GR ASW120)
- Threads of stainless steel fittings must be lubricated.

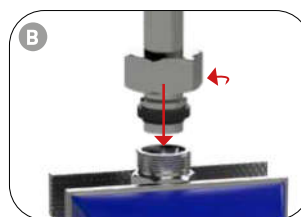

- Siga instrucciones de la imagen
- Utilizar el cuerpo del racor una única vez (use herramientas de montaje Z VOMO)
- Realiza el roscado de forma manual
- Follow picture instructions
- Fitting body may be used one time only (use preassembly tools Z VOMO)
- Screw on nut until finger-tight

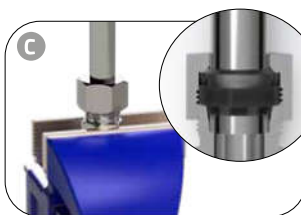

- Presione firmemente el final del tubo en el cono de montaje.
- Press tube-end firmly into the assembly cone.



- Apriete hasta notar un fuerte incremento de resistencia (aprox. 1 ó 1,5 vueltas)
- Tighten until sharp increase of resistance (approx. 1 to 1 1/2 turns)

3 COMPROBACIÓN DEL MONTAJE - CONTROL
 ASSEMBLY CHECK - CONTROL

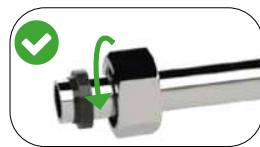
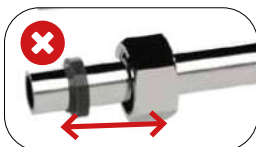

CONTROL ZACJ2/ACJ2: COMPROBAR EL ESPACIO ENTRE EL ANILLO DE ESTANQUEIDAD Y EL DE RETENCIÓN

ZACJ2/ACJ2 CONTROL: GAP BETWEEN SEALING RING AND RETAINING RING MUST BE CHECKED

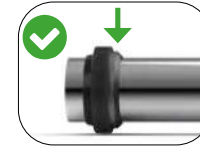
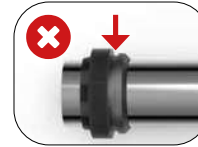

4 MONTAJE FINAL: INSTALACIÓN DEL SISTEMA DE TUBO
 FINAL ASSEMBLY: INSTALLATION OF THE TUBE SYSTEM



- Repetir paso 2.A
- Repeat step 2. A

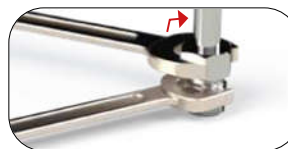

- Monta el racor hasta que quede apretado usando la llave. Apriete fuertemente el racor 1 ó 1,5 vueltas, en giros de 60°-90°.
- Assemble fitting until wrench-tight. Then tighten fitting firmly by min. 1/6 (max. 1/4) turns (1 1/2 flats)

Tubo TrΔle® métrico

TrΔle® metric pipe
Tube rigide TrΔle® métrique
Tubo rigido TrΔle® metrico

Métrico • Metric • Métrique • Metrico

| 104



ZTH0

ZTH0...-3

Racores DIN 2353

DIN 2353 Pipe fittings
Raccords à bague DIN 2353
Raccordi DIN 2353

Tuercas y anillos • Nuts and cutting rings • Écrous et bagues • Dadi e anelli

| 105



Uniones tubo-tubo • Straight couplings • Raccords union double • Raccordi intermedi

| 107



Uniones rectas tubo-rosca • Straight male stud couplings • Raccords union simple mâle • Raccordi di estremità diritti | 109



Codos tubo-rosca • Male stud elbows • Raccords coude mâle gaz • Raccordi di estremità a 90°

| 112



TES rosca lateral • Male stud barrel • Raccords Té mâle latéral • Raccordi di estremità a L

| 113



TES rosca central • Male stud branch • Raccords Té mâle central • Raccordi di estremità a T

| 113



Uniones Métricas • Metric unions • Raccords union Métrique • Raccordi Metrici

| 114



Reducciones roscadas • Reductions • Raccords de réduction • Raccordi di riduzione filettati

| 115



Racores regulables • Adjustable stud couplings • Raccords réglables • Raccordi orientabili

| 116



Racores DIN 2353

DIN 2353 Pipe fittings
Raccords à bague DIN 2353
Raccordi DIN 2353

Tubo roscado (hembra giratoria) • Adjustable straight stud • Raccords tube fileté • Raccordi di estremità per combinazioni | 117



ZATL/ZATS ZRAL/ZRAS BSP TLM WD ZRAL/ZRAS NPT TLM ZRAL/ZRAS METRIC TLM WD

Soldables • Welding fittings • Raccords à souder • Raccordi a saldare | 118



ZASL/ZASS ZESVL/ZESVS ZORIL/ZORIS

Pasatabiques • Bulkhead • Raccords passe cloison • Raccordi passaparete | 119



ZSVL/ZSVS ZUSVL/ZUSVS KZTPM

Racor recto hembra • Straight female coupling • Raccords droits femelle • Raccordi diritti con estremità femmina | 120



ZGAIL/ZGAIS BSP ZMAVL/ZMAVS ZAM ZGAIL/ZGAIS METRIC ZMAFL/ZMFAS

Orientables • Banjos • Raccords orientables • Raccordi orientabili ad occhio | 121



ZWSVL/ZWSVS BSP ZWSVL/ZWSVS METRIC

Tapones • Plugs • Raccords bouchon métrique • Tappi | 122



ZBUTZEN L/S ZSTOPFEN BSP ZSTOPFEN METRIC

Juntas • O-rings & captive seals • Joints • Guarnizioni | 122



JVT JVBSP/JVM

Accesorios para montaje • Accessories for the assembly • Accessoires pour le montage • Accessori per assemblaggio | 123



ZVOMO Grasa

Válvulas antirretorno • Valves • Valves clapet antiretour • Valvole di ritegno | 124



ZRHVL/ZRHVS ZRHZL/ZRHZS ZRHDL/ZRHDS

Racores JIC 37º

Flare fittings JIC 37º

Adapteurs JIC 37º

Raccordi JIC 37º

Tuercas, ferulas y tapones JIC 37º • JIC 37º Nuts, sleeves and plugs • Écrous, ferrules et bouchons JIC 37º •
Dadi, bussole e tappi JIC 37º

125



ZS110

ZS120

ZS121

ZS140

ZS130

Uniones rectas JIC 37º • JIC 37º Straight unions • Union droite JIC 37º • Adattatori diritti JIC 37º

126



ZS260

ZS260

ZS250

ZS260_OR

ZS240

ZS200

ZS380

ZS230

ZS180

ZS210

ZS295

ZS740

ZS291

ZS290

ZS185

JVMET

JVUNF

ZS730

JVMBSP

JTVJIC

Codos 90º JIC 37º • JIC 37º 90º Elbows • Coudes 90º JIC 37º • Adattatori a 90º JIC 37º

131



ZS500

ZS675

ZS700

ZS500_OR

ZS650

ZS570

ZS575

ZS550

ZS595

ZS525

Codos 45º JIC 37º • JIC 37º 45º Elbows • Coudes 45º JIC 37º • Adattatori a 45º JIC 37º

133



ZS690

ZS775

ZS725

Tes JIC 37º • JIC 37º Tees • Tés JIC 37º • Adattatori a T JIC 37º

134



ZS505

ZS680

ZS630

ZS505_OR

ZS685

ZS625

Tubo TrΔle® métrico

TrΔle® metric pipe
Tube rigide TrΔle® métrique
Tubo rigido TrΔle® metrico

Tubo rígido - 6 mts

Rigid pipe - 6 mts

Tube rigide - 6 mts

Tubo rigido Inox - 6 metri



Tubo rígido - 3 mts

Rigid pipe - 3 mts

Tube rigide - 3 mts

Tubo rigido Inox - 3 metri



Ø EXT. Ø OUTER	Ø INT. Ø INNER	Referencia Part n°
6	4	ZTH0060100
6	3	ZTH0060150
8	6	ZTH0080100
8	5	ZTH0080150
10	8	ZTH0100100
10	7	ZTH0100150
10	6	ZTH0100200
12	10	ZTH0120100
12	9	ZTH0120150
12	8	ZTH0120200
12	7	ZTH0120250
14	10	ZTH0140200
15	12	ZTH0150150
16	12	ZTH0160200
16	10	ZTH0160300
18	15	ZTH0180150
18	14	ZTH0180200
20	14	ZTH0200300
22	18	ZTH0220200
25	20	NEW ZTH0250250
25	19	ZTH0250300
28	24	ZTH0280200
30	24	ZTH0300300
35	31	ZTH0350200
38	30	ZTH0380400
42	38	ZTH0420200
42	36	ZTH0420300

Precio por metro. / Price per meter. / Les prix sont par mètre. / I prezzi si intendono al metro

Ø EXT. Ø OUTER	Ø INT. Ø INNER	Referencia Part n°
6	4	ZTH0060100-3
6	3	ZTH0060150-3
8	6	ZTH0080100-3
8	5	ZTH0080150-3
10	8	ZTH0100100-3
10	7	ZTH0100150-3
12	10	ZTH0120100-3
10	6	ZTH0100200-3
12	9	ZTH0120150-3
12	8	ZTH0120200-3
12	7	ZTH0120250-3
14	10	ZTH0140200-3
15	12	ZTH0150150-3
16	12	ZTH0160200-3
16	10	ZTH0160300-3
18	15	ZTH0180150-3
18	14	ZTH0180200-3
20	14	ZTH0200300-3
22	18	ZTH0220200-3
25	20	NEW ZTH0250250-3
25	19	ZTH0250300-3
28	24	ZTH0280200-3
30	24	ZTH0300300-3
35	31	ZTH0350200-3
38	30	ZTH0380400-3
42	38	ZTH0420200-3
42	36	ZTH0420300-3

Precio por metro. / Price per meter. / Les prix sont par mètre. / I prezzi si intendono al metro

TUBO SCHEDULE PIPE

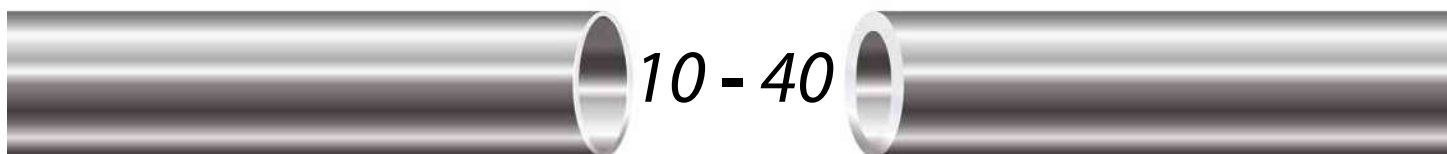

PÁGINA | PAGE
143

Consulta en nuestra ficha técnica datos | Check our technical sheet for data

Racores DIN 2353

DIN 2353 Pipe fittings
Raccords à bague DIN 2353
Raccordi DIN 2353

Tuercas Métricas DIN 3870

Nuts DIN 3870

Écrou DIN 3870

Dado DIN 3870



TUBO PIPE	SERIE SERIES	ROSCA THREAD	Referencia Part n°
4	LL	M8X1	Z MLL 4
6	LL	M10X1	Z MLL 6
8	LL	M12X1	Z MLL 8
6	L	M12X1,5	Z ML 6
8	L	M14X1,5	Z ML 8
10	L	M16X1,5	Z ML 10
12	L	M18X1,5	Z ML 12
15	L	M22X1,5	Z ML 15
18	L	M26X1,5	Z ML 18
22	L	M30X2	Z ML 22
28	L	M36X2	Z ML 28
35	L	M45X2	Z ML 35
42	L	M52X2	Z ML 42
6	S	M14X1,5	Z MS 6
8	S	M16X1,5	Z MS 8
10	S	M18X1,5	Z MS 10
12	S	M20X1,5	Z MS 12
14	S	M22X1,5	Z MS 14
16	S	M24X1,5	Z MS 16
20	S	M30X2	Z MS 20
25	S	M36X2	Z MS 25
30	S	M42X2	Z MS 30
38	S	M52X2	Z MS 38

Anillos de corte DIN 3861

Cutting rings DIN 3861

Bague DIN 3861

Anello DIN 3861



TUBO PIPE	SERIE SERIES	Referencia Part n°
4	LL	Z ACLL 4
6	LL	Z ACLL 6
8	LL	Z ACLL 8
6	L/S	Z ACL 6
8	L/S	Z ACL 8
10	L/S	Z ACL 10
12	L/S	Z ACL 12
15	L	Z ACL 15
18	L	Z ACL 18
22	L	Z ACL 22
28	L	Z ACL 28
35	L	Z ACL 35
42	L	Z ACL 42
14	S	Z ACS 14
16	S	Z ACS 16
20	S	Z ACS 20
25	S	Z ACS 25
30	S	Z ACS 30
38	S	Z ACS 38

Anillos de refuerzo

Reinforced ring

Bague de renforcement

Anello di rinforzo



TUBO PIPE	Referencia Part n°	€
4	Z VHS 4	*
5	Z VHS 5	*
6	Z VHS 6	*
7	Z VHS 7	*
8	Z VHS 8	*
9	Z VHS 9	*
10	Z VHS 10	*
11	Z VHS 11	*
12	Z VHS 12	*
13	Z VHS 13	*
14	Z VHS 14	*
15	Z VHS 15	*
16	Z VHS 16	*
17	Z VHS 17	*
18	Z VHS 18	*
19	Z VHS 19	*
20	Z VHS 20	*
22	Z VHS 22	*
24	Z VHS 24	*
25	Z VHS 25	*
31	Z VHS 31	*
33	Z VHS 33	*
38	Z VHS 38	*

Anillos de corte con junta

Cutting ring with joint

Bague avec joint

Anello tagliante con guarnizione



TUBO PIPE	SERIE SERIES	Referencia Part n°
6	L	Z ACJL 6
8	L	Z ACJL 8
10	L	Z ACJL 10
12	L	Z ACJL 12
15	L	Z ACJL 15
18	L	Z ACJL 18
22	L	Z ACJL 22
28	L	Z ACJL 28
35	L	Z ACJL 35
42	L	Z ACJL 42
6	S	Z ACJS 6
8	S	Z ACJS 8
10	S	Z ACJS 10
12	S	Z ACJS 12
14	S	Z ACJS 14
16	S	Z ACJS 16
20	S	Z ACJS 20
25	S	Z ACJS 25
30	S	Z ACJS 30
38	S	Z ACJS 38

CRIMPING FITTINGS FOR HOSES
PIPE FITTINGS
PIPE FITTINGS II
ADAPTORS
WELDING FITTINGS
INDUSTRIAL FITTINGS
ACCESSORIES
CONTROL COMPONENTS
FLOW MEASURING
TRALE LOK

Racores DIN 2353

DIN 2353 Pipe fittings
Raccords à bague DIN 2353
Raccordi DIN 2353

Anillos de corte con junta ZACJ2

S.S.Cutting ring with joint ZACJ2

Bague Acier inox avec joint ZACJ2

Anello tagliante con guarnizione ZACJ2



Tuerca equipada ZACJ2

ZACJ2 Equipped Nut

Écrou équipé ZACJ2

Dado DIN + guarnizione ZACJ2



TUBO PIPE	SERIE SERIES	Referencia Part n°
6	L	Z ACJ2L 6
8	L	Z ACJ2L 8
10	L	Z ACJ2L 10
12	L	Z ACJ2L 12
15	L	Z ACJ2L 15
18	L	Z ACJ2L 18
22	L	Z ACJ2L 22
28	L	Z ACJ2L 28
35	L	Z ACJ2L 35
42	L	Z ACJ2L 42
6	S	Z ACJ2S 6
8	S	Z ACJ2S 8
10	S	Z ACJ2S 10
12	S	Z ACJ2S 12
14	S	Z ACJ2S 14
16	S	Z ACJ2S 16
20	S	Z ACJ2S 20
25	S	Z ACJ2S 25
30	S	Z ACJ2S 30
38	S	Z ACJ2S 38

TUBO PIPE	SERIE SERIES	ROSCA THREAD	Referencia Part n°
6	L	M12X1,5	Z MJ2L 6
8	L	M14X1,5	Z MJ2L 8
10	L	M16X1,5	Z MJ2L 10
12	L	M18X1,5	Z MJ2L 12
15	L	M22X1,5	Z MJ2L 15
18	L	M26X1,5	Z MJ2L 18
22	L	M30X2	Z MJ2L 22
28	L	M36X2	Z MJ2L 28
35	L	M45X2	Z MJ2L 35
42	L	M52X2	Z MJ2L 42
6	S	M14X1,5	Z MJ2S 6
8	S	M16X1,5	Z MJ2S 8
10	S	M18X1,5	Z MJ2S 10
12	S	M20X1,5	Z MJ2S 12
14	S	M22X1,5	Z MJ2S 14
16	S	M24X1,5	Z MJ2S 16
20	S	M30X2	Z MJ2S 20
25	S	M36X2	Z MJ2S 25
30	S	M42X2	Z MJ2S 30
38	S	M52X2	Z MJ2S 38

PREVENTS LEAKS IN EQUIPMENT SUBJECT TO HIGH VIBRATIONS
EVITA FUGAS EN EQUIPAMIENTOS SOMETIDOS A ALTAS VIBRACIONES



ZACJ2

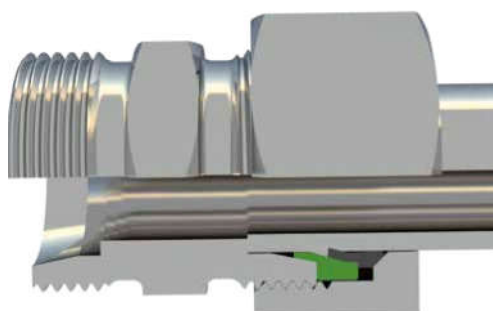

- ‡ Pressure rating up to 800 bar (PN)
- ‡ Reduction of tightening torques up to 25%
- ‡ Easier assembly
- ‡ Simple handling through functional nut

- ‡ Hasta una presión nominal (PN) de 800 bar
- ‡ Reducción de los pares de apriete en hasta 25%
- ‡ Un montaje aún más sencillo
- ‡ Sencillo manejo mediante tuerca funcional

Racores DIN 2353

DIN 2353 Pipe fittings
Raccords à bague DIN 2353
Raccordi DIN 2353

Racor unión recta tubo - tubo

Straight coupling

Raccord union double

Raccordo intermedio diritto



TUBO PIPE	SERIE SERIES	Referencia Part n°	€	Referencia STA Part N° STA
4	LL	Z DLL 4	34,22	---
6	LL	Z DLL 6	30,00	---
8	LL	Z DLL 8	28,95	---
6	L	Z DL 6	16,65	Z STA DL 6
8	L	Z DL 8	17,44	Z STA DL 8
10	L	Z DL 10	19,36	Z STA DL 10
12	L	Z DL 12	21,43	Z STA DL 12
15	L	Z DL 15	30,44	Z STA DL 15
18	L	Z DL 18	36,35	Z STA DL 18
22	L	Z DL 22	48,06	Z STA DL 22
28	L	Z DL 28	70,88	Z STA DL 28
35	L	Z DL 35	111,31	Z STA DL 35
42	L	Z DL 42	176,78	Z STA DL 42
6	S	Z DS 6	19,42	Z STA DS 6
8	S	Z DS 8	20,08	Z STA DS 8
10	S	Z DS 10	25,50	Z STA DS 10
12	S	Z DS 12	29,53	Z STA DS 12
14	S	Z DS 14	37,87	Z STA DS 14
16	S	Z DS 16	37,65	Z STA DS 16
20	S	Z DS 20	56,77	Z STA DS 20
25	S	Z DS 25	115,40	Z STA DS 25
30	S	Z DS 30	142,58	Z STA DS 30
38	S	Z DS 38	194,36	Z STA DS 38

Racor unión en codo tubo - tubo

Equal elbow coupling

Raccord coude égal

Raccordo intermedio a 90°



TUBO PIPE	SERIE SERIES	Referencia Part n°	€	Referencia STA Part N° STA
4	LL	Z ELL 4	51,01	---
6	LL	Z ELL 6	45,30	---
8	LL	Z ELL 8	49,13	---
6	L	Z EL 6	27,57	Z STA EL 6
8	L	Z EL 8	28,86	Z STA EL 8
10	L	Z EL 10	32,51	Z STA EL 10
12	L	Z EL 12	35,53	Z STA EL 12
15	L	Z EL 15	46,98	Z STA EL 15
18	L	Z EL 18	62,46	Z STA EL 18
22	L	Z EL 22	86,74	Z STA EL 22
28	L	Z EL 28	127,41	Z STA EL 28
35	L	Z EL 35	202,28	Z STA EL 35
42	L	Z EL 42	316,97	Z STA EL 42
6	S	Z ES 6	31,63	Z STA ES 6
8	S	Z ES 8	34,90	Z STA ES 8
10	S	Z ES 10	37,42	Z STA ES 10
12	S	Z ES 12	41,60	Z STA ES 12
14	S	Z ES 14	52,90	Z STA ES 14
16	S	Z ES 16	59,99	Z STA ES 16
20	S	Z ES 20	89,62	Z STA ES 20
25	S	Z ES 25	159,93	Z STA ES 25
30	S	Z ES 30	222,75	Z STA ES 30
38	S	Z ES 38	317,89	Z STA ES 38

Racor unión recta en reducción tubo - tubo

Straight reducing coupling

Raccord union double en réduction

Raccordo intermedio di riduzione



TUBO PIPE	PIPE	SERIE SERIES	Referencia Part n°	€	Referencia STA Part N° STA
8	6	L	Z DL 8-6	19,43	Z STA DL 8-6
10	6	L	Z DL 10-6	20,66	Z STA DL 10-6
10	8	L	Z DL 10-8	18,51	Z STA DL 10-8
12	6	L	Z DL 12-6	28,45	Z STA DL 12-6
12	8	L	Z DL 12-8	28,60	Z STA DL 12-8
12	10	L	Z DL 12-10	21,84	Z STA DL 12-10
15	6	L	Z DL 15-6	36,45	Z STA DL 15-6
15	8	L	Z DL 15-8	39,31	Z STA DL 15-8
15	10	L	Z DL 15-10	30,14	Z STA DL 15-10
15	12	L	Z DL 15-12	26,94	Z STA DL 15-12
18	8	L	Z DL 18-8	42,57	Z STA DL 18-8
18	10	L	Z DL 18-10	34,38	Z STA DL 18-10
18	12	L	Z DL 18-12	35,14	Z STA DL 18-12
18	15	L	Z DL 18-15	39,65	Z STA DL 18-15
22	12	L	Z DL 22-12	46,92	Z STA DL 22-12
22	15	L	Z DL 22-15	45,66	Z STA DL 22-15
22	18	L	Z DL 22-18	49,86	Z STA DL 22-18
28	22	L	Z DL 28-22	76,02	Z STA DL 28-22
35	28	L	Z DL 35-28	123,84	Z STA DL 35-28
42	28	L	Z DL 42-28	148,85	Z STA DL 42-28
42	35	L	Z DL 42-35	206,95	Z STA DL 42-35
8	6	S	Z DS 8-6	27,11	Z STA DS 8-6
10	6	S	Z DS 10-6	28,81	Z STA DS 10-6
10	8	S	Z DS 10-8	28,30	Z STA DS 10-8
12	6	S	Z DS 12-6	32,62	Z STA DS 12-6
12	8	S	Z DS 12-8	31,71	Z STA DS 12-8
12	10	S	Z DS 12-10	30,53	Z STA DS 12-10
14	10	S	Z DS 14-10	36,71	Z STA DS 14-10
16	10	S	Z DS 16-10	52,94	Z STA DS 16-10
16	12	S	Z DS 16-12	37,17	Z STA DS 16-12
16	14	S	Z DS 16-14	42,49	Z STA DS 16-14
20	10	S	Z DS 20-10	60,92	Z STA DS 20-10
20	12	S	Z DS 20-12	74,07	Z STA DS 20-12
20	14	S	Z DS 20-14	82,38	Z STA DS 20-14
20	16	S	Z DS 20-16	57,63	Z STA DS 20-16
25	16	S	Z DS 25-16	92,95	Z STA DS 25-16
25	20	S	Z DS 25-20	98,01	Z STA DS 25-20
30	20	S	Z DS 30-20	126,35	Z STA DS 30-20
30	25	S	Z DS 30-25	166,65	Z STA DS 30-25
38	25	S	Z DS 38-25	182,40	Z STA DS 38-25
38	30	S	Z DS 38-30	205,07	Z STA DS 38-30

Racores DIN 2353

DIN 2353 Pipe fittings
Raccords à bague DIN 2353
Raccordi DIN 2353

Racor unión en T tubo - tubo

Equal Tee

Raccord Té égal

Raccordo intermedio a T



Racor unión en cruz tubo - tubo

Equal cross

Raccord croix égale

Raccordo intermedio a croce



TUBO PIPE	SERIE SERIES	Referencia Part n°	€	Referencia STA Part N° STA
4	LL	Z TLL 4	65,92	---
6	LL	Z TLL 6	66,67	---
8	LL	Z TLL 8	72,82	---
6	L	Z TL 6	35,33	Z STA TL 6
8	L	Z TL 8	38,30	Z STA TL 8
10	L	Z TL 10	41,05	Z STA TL 10
12	L	Z TL 12	45,71	Z STA TL 12
15	L	Z TL 15	63,39	Z STA TL 15
18	L	Z TL 18	82,36	Z STA TL 18
22	L	Z TL 22	114,31	Z STA TL 22
28	L	Z TL 28	170,42	Z STA TL 28
35	L	Z TL 35	296,67	Z STA TL 35
42	L	Z TL 42	417,17	Z STA TL 42
6	S	Z TS 6	44,15	Z STA TS 6
8	S	Z TS 8	45,87	Z STA TS 8
10	S	Z TS 10	51,71	Z STA TS 10
12	S	Z TS 12	60,00	Z STA TS 12
14	S	Z TS 14	76,88	Z STA TS 14
16	S	Z TS 16	82,42	Z STA TS 16
20	S	Z TS 20	119,47	Z STA TS 20
25	S	Z TS 25	226,96	Z STA TS 25
30	S	Z TS 30	328,14	Z STA TS 30
38	S	Z TS 38	466,52	Z STA TS 38

TUBO PIPE	SERIE SERIES	Referencia Part n°	€	Referencia STA Part N° STA
6	L	Z KVL 6	70,20	Z STA KVL 6
8	L	Z KVL 8	71,41	Z STA KVL 8
10	L	Z KVL 10	94,35	Z STA KVL 10
12	L	Z KVL 12	91,77	Z STA KVL 12
15	L	Z KVL 15	137,66	Z STA KVL 15
18	L	Z KVL 18	155,70	Z STA KVL 18
22	L	Z KVL 22	192,30	Z STA KVL 22
28	L	Z KVL 28	223,20	Z STA KVL 28
35	L	Z KVL 35	556,50	Z STA KVL 35
42	L	Z KVL 42	798,30	Z STA KVL 42
6	S	Z KVS 6	79,44	Z STA KVS 6
8	S	Z KVS 8	91,10	Z STA KVS 8
10	S	Z KVS 10	118,78	Z STA KVS 10
12	S	Z KVS 12	136,55	Z STA KVS 12
14	S	Z KVS 14	181,21	Z STA KVS 14
16	S	Z KVS 16	196,60	Z STA KVS 16
20	S	Z KVS 20	215,25	Z STA KVS 20
25	S	Z KVS 25	311,62	Z STA KVS 25
30	S	Z KVS 30	419,80	Z STA KVS 30
38	S	Z KVS 38	674,76	Z STA KVS 38

Racores DIN 2353

DIN 2353 Pipe fittings
Raccords à bague DIN 2353
Raccordi DIN 2353

Racor recto rosca cilíndrica BSP cono 60°

Straight male stud coupling BSP cyl. 60°

Raccord Union simple mâle gaz cylindrique 60°

Raccordo di estremità diritto BSP sede 60°



Racor recto rosca cilíndrica BSP con junta

Straight male stud coupling BSP cylindrical with captive seal

Raccord union simple mâle gaz cylindrique avec joint plat

Raccordo di estremità diritto BSP con guarnizione



TUBO PIPE	ROSCA THREAD	SERIE SERIES	Referencia Part n°	€	Referencia STA Part N° STA
6	1/8" BSP	L	Z AL 6 RC 1/8	11,26	Z STA AL 6 RC 1/8
6	1/4" BSP	L	Z AL 6 RC 1/4	16,84	Z STA AL 6 RC 1/4
6	3/8" BSP	L	Z AL 6 RC 3/8	25,81	Z STA AL 6 RC 3/8
6	1/2" BSP	L	Z AL 6 RC 1/2	36,27	Z STA AL 6 RC 1/2
8	1/8" BSP	L	Z AL 8 RC 1/8	16,47	Z STA AL 8 RC 1/8
8	1/4" BSP	L	Z AL 8 RC 1/4	15,09	Z STA AL 8 RC 1/4
8	3/8" BSP	L	Z AL 8 RC 3/8	18,52	Z STA AL 8 RC 3/8
8	1/2" BSP	L	Z AL 8 RC 1/2	29,89	Z STA AL 8 RC 1/2
10	1/8" BSP	L	Z AL 10 RC 1/8	18,15	Z STA AL 10 RC 1/8
10	1/4" BSP	L	Z AL 10 RC 1/4	14,74	Z STA AL 10 RC 1/4
10	3/8" BSP	L	Z AL 10 RC 3/8	17,66	Z STA AL 10 RC 3/8
10	1/2" BSP	L	Z AL 10 RC 1/2	23,66	Z STA AL 10 RC 1/2
12	1/4" BSP	L	Z AL 12 RC 1/4	17,47	Z STA AL 12 RC 1/4
12	3/8" BSP	L	Z AL 12 RC 3/8	17,37	Z STA AL 12 RC 3/8
12	1/2" BSP	L	Z AL 12 RC 1/2	22,40	Z STA AL 12 RC 1/2
15	3/8" BSP	L	Z AL 15 RC 3/8	24,00	Z STA AL 15 RC 3/8
15	1/2" BSP	L	Z AL 15 RC 1/2	25,81	Z STA AL 15 RC 1/2
15	3/4" BSP	L	Z AL 15 RC 3/4	34,75	Z STA AL 15 RC 3/4
18	1/2" BSP	L	Z AL 18 RC 1/2	31,01	Z STA AL 18 RC 1/2
18	3/4" BSP	L	Z AL 18 RC 3/4	33,41	Z STA AL 18 RC 3/4
18	3/8" BSP	L	Z AL 18 RC 3/8	34,64	Z STA AL 18 RC 3/8
22	3/8" BSP	L	Z AL 22 RC 3/8	42,32	Z STA AL 22 RC 3/8
22	1/2" BSP	L	Z AL 22 RC 1/2	41,47	Z STA AL 22 RC 1/2
22	3/4" BSP	L	Z AL 22 RC 3/4	37,70	Z STA AL 22 RC 3/4
22	1" BSP	L	Z AL 22 RC 1	51,45	Z STA AL 22 RC 1
28	3/4" BSP	L	Z AL 28 RC 3/4	50,05	Z STA AL 28 RC 3/4
28	1" BSP	L	Z AL 28 RC 1	53,87	Z STA AL 28 RC 1
35	1" 1/4 BSP	L	Z AL 35 RC 1 1/4	98,85	Z STA AL 35 RC 1 1/4
35	1" 1/2 BSP	L	Z AL 35 RC 1 1/2	96,01	Z STA AL 35 RC 1 1/2
42	1" 1/4 BSP	L	Z AL 42 RC 1 1/4	131,87	Z STA AL 42 RC 1 1/4
42	1" 1/2 BSP	L	Z AL 42 RC 1 1/2	119,19	Z STA AL 42 RC 1 1/2
6	1/4" BSP	S	Z AS 6 RC 1/4	23,79	Z STA AS 6 RC 1/4
6	3/8" BSP	S	Z AS 6 RC 3/8	22,56	Z STA AS 6 RC 3/8
8	1/4" BSP	S	Z AS 8 RC 1/4	17,21	Z STA AS 8 RC 1/4
8	3/8" BSP	S	Z AS 8 RC 3/8	20,69	Z STA AS 8 RC 3/8
8	1/2" BSP	S	Z AS 8 RC 1/2	32,20	Z STA AS 8 RC 1/2
10	1/4" BSP	S	Z AS 10 RC 1/4	17,56	Z STA AS 10 RC 1/4
10	3/8" BSP	S	Z AS 10 RC 3/8	25,56	Z STA AS 10 RC 3/8
10	1/2" BSP	S	Z AS 10 RC 1/2	31,86	Z STA AS 10 RC 1/2
12	1/4" BSP	S	Z AS 12 RC 1/4	23,43	Z STA AS 12 RC 1/4
12	3/8" BSP	S	Z AS 12 RC 3/8	23,24	Z STA AS 12 RC 3/8
12	1/2" BSP	S	Z AS 12 RC 1/2	26,96	Z STA AS 12 RC 1/2
14	3/8" BSP	S	Z AS 14 RC 3/8	35,37	Z STA AS 14 RC 3/8
14	1/2" BSP	S	Z AS 14 RC 1/2	33,84	Z STA AS 14 RC 1/2
16	3/8" BSP	S	Z AS 16 RC 3/8	32,20	Z STA AS 16 RC 3/8
16	1/2" BSP	S	Z AS 16 RC 1/2	28,28	Z STA AS 16 RC 1/2
16	3/4" BSP	S	Z AS 16 RC 3/4	40,80	Z STA AS 16 RC 3/4
20	3/8" BSP	S	Z AS 20 RC 3/8	44,83	Z STA AS 20 RC 3/8
20	1/2" BSP	S	Z AS 20 RC 1/2	40,51	Z STA AS 20 RC 1/2
20	3/4" BSP	S	Z AS 20 RC 3/4	45,28	Z STA AS 20 RC 3/4
20	1" BSP	S	Z AS 20 RC 1	60,82	Z STA AS 20 RC 1
25	3/4" BSP	S	Z AS 25 RC 3/4	75,39	Z STA AS 25 RC 3/4
25	1" BSP	S	Z AS 25 RC 1	77,91	Z STA AS 25 RC 1
25	1" 1/4 BSP	S	Z AS 25 RC 1 1/4	106,70	Z STA AS 25 RC 1 1/4
30	1" BSP	S	Z AS 30 RC 1	107,41	Z STA AS 30 RC 1
30	1" 1/4 BSP	S	Z AS 30 RC 1 1/4	124,52	Z STA AS 30 RC 1 1/4
30	1" 1/2 BSP	S	Z AS 30 RC 1 1/2	113,80	Z STA AS 30 RC 1 1/2
38	1" 1/4 BSP	S	Z AS 38 RC 1 1/4	143,94	Z STA AS 38 RC 1 1/4
38	1" 1/2 BSP	S	Z AS 38 RC 1 1/2	148,72	Z STA AS 38 RC 1 1/2

TUBO PIPE	SERIE SERIES	ROSCA THREAD	Referencia Part n°	€	Referencia STA Part N° STA
6	L	1/8" BSP	Z AL 6 R 1/8WD	14,09	Z STA AL 6 R 1/8WD
6	L	1/4" BSP	Z AL 6 R 1/4WD	17,15	Z STA AL 6 R 1/4WD
6	L	3/8" BSP	Z AL 6 R 3/8WD	18,45	Z STA AL 6 R 3/8WD
8	L	1/8" BSP	Z AL 8 R 1/8WD	15,20	Z STA AL 8 R 1/8WD
8	L	1/4" BSP	Z AL 8 R 1/4WD	15,31	Z STA AL 8 R 1/4WD
8	L	3/8" BSP	Z AL 8 R 3/8WD	19,08	Z STA AL 8 R 3/8WD
8	L	1/2" BSP	Z AL 8 R 1/2WD	22,46	Z STA AL 8 R 1/2WD
10	L	1/8" BSP	Z AL 10 R 1/8WD	19,10	Z STA AL 10 R 1/8WD
10	L	1/4" BSP	Z AL 10 R 1/4WD	15,83	Z STA AL 10 R 1/4WD
10	L	3/8" BSP	Z AL 10 R 3/8WD	19,22	Z STA AL 10 R 3/8WD
10	L	1/2" BSP	Z AL 10 R 1/2WD	23,91	Z STA AL 10 R 1/2WD
12	L	1/4" BSP	Z AL 12 R 1/4WD	18,81	Z STA AL 12 R 1/4WD
12	L	3/8" BSP	Z AL 12 R 3/8WD	18,63	Z STA AL 12 R 3/8WD
12	L	1/2" BSP	Z AL 12 R 1/2WD	22,88	Z STA AL 12 R 1/2WD
15	L	3/8" BSP	Z AL 15 R 3/8WD	26,18	Z STA AL 15 R 3/8WD
15	L	1/2" BSP	Z AL 15 R 1/2WD	25,47	Z STA AL 15 R 1/2WD
15	L	3/4" BSP	Z AL 15 R 3/4WD	33,80	Z STA AL 15 R 3/4WD
18	L	3/8" BSP	Z AL 18 R 3/8WD	37,46	Z STA AL 18 R 3/8WD
18	L	1/2" BSP	Z AL 18 R 1/2WD	28,75	Z STA AL 18 R 1/2WD
18	L	3/4" BSP	Z AL 18 R 3/4WD	35,50	Z STA AL 18 R 3/4WD
22	L	1/2" BSP	Z AL 22 R 1/2WD	40,38	Z STA AL 22 R 1/2WD
22	L	3/4" BSP	Z AL 22 R 3/4WD	35,80	Z STA AL 22 R 3/4WD
22	L	1" BSP	Z AL 22 R 1WD	50,00	Z STA AL 22 R 1WD
28	L	3/4" BSP	Z AL 28 R 3/4WD	56,16	Z STA AL 28 R 3/4WD
28	L	1" BSP	Z AL 28 R 1WD	56,05	Z STA AL 28 R 1WD
35	L	1" BSP	Z AL 35 R 1WD	90,22	Z STA AL 35 R 1WD
35	L	1" 1/4 BSP	Z AL 35 R 1 1/4WD	95,71	Z STA AL 35 R 1 1/4WD
42	L	1" 1/4 BSP	Z AL 42 R 1 1/4WD	161,04	Z STA AL 42 R 1 1/4WD
42	L	1" 1/2 BSP	Z AL 42 R 1 1/2WD	127,17	Z STA AL 42 R 1 1/2WD
6	S	1/4" BSP	Z AS 6 R 1/4WD	20,40	Z STA AS 6 R 1/4WD
8	S	1/4" BSP	Z AS 8 R 1/4WD	20,22	Z STA AS 8 R 1/4WD
8	S	3/8" BSP	Z AS 8 R 3/8WD	22,22	Z STA AS 8 R 3/8WD
8	S	1/2" BSP	Z AS 8 R 1/2WD	27,30	Z STA AS 8 R 1/2WD
10	S	1/4" BSP	Z AS 10 R 1/4WD	20,96	Z STA AS 10 R 1/4WD
10	S	3/8" BSP	Z AS 10 R 3/8WD	24,17	Z STA AS 10 R 3/8WD
10	S	1/2" BSP	Z AS 10 R 1/2WD	31,58	Z STA AS 10 R 1/2WD
12	S	1/4" BSP	Z AS 12 R 1/4WD	26,55	Z STA AS 12 R 1/4WD
12	S	3/8" BSP	Z AS 12 R 3/8WD	23,39	Z STA AS 12 R 3/8WD
12	S	1/2" BSP	Z AS 12 R 1/2WD	29,64	Z STA AS 12 R 1/2WD
14	S	3/8" BSP	Z AS 14 R 3/8WD	36,07	Z STA AS 14 R 3/8WD
14	S	1/2" BSP	Z AS 14 R 1/2WD	32,72	Z STA AS 14 R 1/2WD
16	S	3/8" BSP	Z AS 16 R 3/8WD	30,82	Z STA AS 16 R 3/8WD
16	S	1/2" BSP	Z AS 16 R 1/2WD	29,97	Z STA AS 16 R 1/2WD
16	S	3/4" BSP	Z AS 16 R 3/4WD	37,64	Z STA AS 16 R 3/4WD
20	S	1/2" BSP	Z AS 20 R 1/2WD	43,90	Z STA AS 20 R 1/2WD
20	S	3/4" BSP	Z AS 20 R 3/4WD	42,05	Z STA AS 20 R 3/4WD
25	S	3/4" BSP	Z AS 25 R 3/4WD	80,94	Z STA AS 25 R 3/4WD
25	S	1" BSP	Z AS 25 R 1WD	83,69	Z STA AS 25 R 1WD
25	S	1" 1/4 BSP	Z AS 25 R 1 1/4WD	107,85	Z STA AS 25 R 1 1/4WD
30	S	1" BSP	Z AS 30 R 1WD	91,25	Z STA AS 30 R 1WD
30	S	1" 1/4 BSP	Z AS 30 R 1 1/4WD	114,29	Z STA AS 30 R 1 1/4WD
30	S	1" 1/2 BSP	Z AS 30 R 1 1/2WD	161,62	Z STA AS 30 R 1 1/2WD
38	S	1" 1/4 BSP	Z AS 38 R 1 1/4WD	151,20	Z STA AS 38 R 1 1/4WD
38	S	1" 1/2 BSP	Z AS 38 R 1 1/2WD	141,79	Z STA AS 38 R 1 1/2WD

CRIMPING FITTINGS
FOR HOSES

PIPE
FITTINGS

PIPE
FITTINGS II

ADAPTORS

WELDING
FITTINGS

INDUSTRIAL
FITTINGS

ACCESSORIES

CONTROL
COMPONENTS

FLOW
MEASURING

TRALE LOK

CRIMPING FITTINGS
FOR HOSES

PIPE
FITTINGS

PIPE
FITTINGS II

ADAPTORS

WELDING
FITTINGS

INDUSTRIAL
FITTINGS

ACCESSORIES

CONTROL
COMPONENTS

FLOW
MEASURING

TRAILER LOK

Racores DIN 2353

DIN 2353 Pipe fittings
Raccords à bague DIN 2353
Raccordi DIN 2353

Racor recto rosca cilíndrica BSP

Straight male stud coupling BSP cylindrical

Raccord union simple gaz cylindrique mâle

Raccordo di estremità diritto BSP



Racor recto rosca UNF

Straight male stud coupling UNF

Raccord union simple mâle UNF

Raccordo di estremità diritto UNF



TUBO PIPE	SERIE SERIES	ROSCA THREAD	Referencia Part n°	€	Referencia STA Part N° STA
6	LL	1/8" BSP	Z ALL 6 R 1/8	14,51	---
10	L	1/8" BSP	Z AL 10 R 1/8	14,80	---
15	L	3/4" BSP	Z AL 15 R 3/4	29,11	---
6	S	1/4" BSP	Z AS 6 R 1/4	18,51	Z STA AS 6 R 1/4
8	S	1/4" BSP	Z AS 8 R 1/4	15,10	Z STA AS 8 R 1/4
8	S	1/2" BSP	Z AS 8 R 1/2	27,25	---
10	S	1/4" BSP	Z AS 10 R 1/4	16,99	Z STA AS 10 R 1/4
10	S	3/8" BSP	Z AS 10 R 3/8	17,40	Z STA AS 10 R 3/8
38	S	1" 1/4 BSP	Z AS 38 R 1 1/4	127,89	Z STA AS 38 R 1 1/4

Hasta fin de existencias / Until end of stock / Jusqu'à la fin du stock / Fino ad esaurimento

TUBO PIPE	SERIE SERIES	ROSCA THREAD	Referencia Part n°	€	Referencia STA Part N° STA
8	L	7/16" UNF	Z AL 8 7/16 UNF	23,49	Z STA AL 8 7/16 UNF
10	L	7/16" UNF	Z AL 10 7/16 UNF	24,40	Z STA AL 10 7/16 UNF
12	L	3/4" UNF	Z AL 12 3/4 UNF	25,60	Z STA AL 12 3/4 UNF
12	L	9/16" UNF	Z AL 12 9/16 UNF	23,07	Z STA AL 12 9/16 UNF
15	L	3/4" UNF	Z AL 15 3/4 UNF	34,73	Z STA AL 15 3/4 UNF
18	L	7/8" UNF	Z AL 18 7/8 UNF	34,84	Z STA AL 18 7/8 UNF
22	L	1" 1/16 UNF	Z AL 22 1 1/16 UNF	42,93	Z STA AL 22 1 1/16 UNF
28	L	1" 5/16 UNF	Z AL 28 1 5/16 UNF	62,40	Z STA AL 28 1 5/16 UNF
35	L	1" 5/8 UNF	Z AL 35 1 5/8 UNF	110,77	Z STA AL 35 1 5/8 UNF
8	S	7/16" UNF	Z AS 8 7/16 UNF	22,54	Z STA AS 8 7/16 UNF
10	S	9/16" UNF	Z AS 10 9/16 UNF	25,70	Z STA AS 10 9/16 UNF
12	S	9/16" UNF	Z AS 12 9/16 UNF	26,65	Z STA AS 12 9/16 UNF
16	S	3/4" UNF	Z AS 16 3/4 UNF	37,75	Z STA AS 16 3/4 UNF
20	S	7/8" UNF	Z AS 20 7/8 UNF	51,81	Z STA AS 20 7/8 UNF
20	S	1" 1/16 UNF	Z AS 20 1 1/16 UNF	54,37	Z STA AS 20 1 1/16 UNF
25	S	1" 5/16 UNF	Z AS 25 1 5/16 UNF	92,51	Z STA AS 25 1 5/16 UNF
30	S	1" 5/16 UNF	Z AS 30 1 5/16 UNF	112,13	Z STA AS 30 1 5/16 UNF
38	S	1" 5/8 UNF	Z AS 38 1 5/8 UNF	185,51	Z STA AS 38 1 5/8 UNF

Racor recto rosca cilíndrica Métrica con junta

Straight male stud coupling Metric cylindrical with captive seal

Raccord union simple mâle cylindrique

Métrique avec joint plat

Raccordo di estremità diritto Metrico con guarnizione



TUBO PIPE	SERIE SERIES	ROSCA THREAD	Referencia Part n°	€	Referencia STA Part N° STA
6	L	M10x1	Z AL 6 M 10X1 WD	12,70	Z STA AL 6 M 10X1 WD
8	L	M12x1.5	Z AL 8 M 12X1.5 WD	16,81	Z STA AL 8 M 12X1.5 WD
10	L	M12x1.5	Z AL 10 M 12X1.5 WD	27,86	Z STA AL 10 M 12X1.5 WD
10	L	M14x1.5	Z AL 10 M 14X1.5 WD	20,20	Z STA AL 10 M 14X1.5 WD
10	L	M16x1.5	Z AL 10 M 16X1.5 WD	22,62	Z STA AL 10 M 16X1.5 WD
12	L	M16x1.5	Z AL 12 M 16X1.5 WD	22,73	Z STA AL 12 M 16X1.5 WD
12	L	M18x1.5	Z AL 12 M 18X1.5 WD	23,67	Z STA AL 12 M 18X1.5 WD
12	L	M22x1.5	Z AL 12 M 22X1.5 WD	30,75	Z STA AL 12 M 22X1.5 WD
15	L	M18x1.5	Z AL 15 M 18X1.5 WD	33,13	Z STA AL 15 M 18X1.5 WD
18	L	M22x1.5	Z AL 18 M 22X1.5 WD	35,79	Z STA AL 18 M 22X1.5 WD
22	L	M26x1.5	Z AL 22 M 26X1.5 WD	43,43	Z STA AL 22 M 26X1.5 WD
28	L	M33x2	Z AL 28 M 33X2 WD	58,27	Z STA AL 28 M 33X2 WD
35	L	M42x2	Z AL 35 M 42X2 WD	129,80	Z STA AL 35 M 42X2 WD
42	L	M48x2	Z AL 42 M 48X2 WD	192,60	Z STA AL 42 M 48X2 WD
6	S	M12x1.5	Z AS 6 M 12X1.5 WD	28,37	Z STA AS 6 M 12X1.5 WD
6	S	M14x1.5	Z AS 6 M 14X1.5 WD	28,56	Z STA AS 6 M 14X1.5 WD
8	S	M14x1.5	Z AS 8 M 14X1.5 WD	30,05	Z STA AS 8 M 14X1.5 WD
10	S	M16x1.5	Z AS 10 M 16X1.5 WD	33,45	Z STA AS 10 M 16X1.5 WD
12	S	M14x1.5	Z AS 12 M 14X1.5 WD	27,63	Z STA AS 12 M 14X1.5 WD
12	S	M18x1.5	Z AS 12 M 18X1.5 WD	26,78	Z STA AS 12 M 18X1.5 WD
14	S	M20x1.5	Z AS 14 M 20X1.5 WD	44,97	Z STA AS 14 M 20X1.5 WD
16	S	M22x1.5	Z AS 16 M 22X1.5 WD	36,54	Z STA AS 16 M 22X1.5 WD
20	S	M27x2	Z AS 20 M 27X2 WD	46,21	Z STA AS 20 M 27X2 WD
25	S	M33x2	Z AS 25 M 33X2 WD	100,79	Z STA AS 25 M 33X2 WD
30	S	M42x2	Z AS 30 M 42X2 WD	140,62	Z STA AS 30 M 42X2 WD
38	S	M48x2	Z AS 38 M 48X2 WD	209,60	Z STA AS 38 M 48X2 WD

Racores DIN 2353

DIN 2353 Pipe fittings
Raccords à bague DIN 2353
Raccordi DIN 2353

Racor recto rosca cónica NPT

Straight male stud coupling NPT

Raccord union simple mâle NPT

Raccordo di estremità diritto conico NPT



TUBO PIPE	SERIE SERIES	ROSCA THREAD	Referencia Part n°	€	Referencia STA Part N° STA
6	L	1/8"NPT	Z AKL 6 1/8 NPT	13,90	Z STA AKL 6 1/8 NPT
6	L	1/4"NPT	Z AKL 6 1/4 NPT	18,64	Z STA AKL 6 1/4 NPT
6	L	3/8"NPT	Z AKL 6 3/8 NPT	24,23	Z STA AKL 6 3/8 NPT
8	L	1/8"NPT	Z AKL 8 1/8 NPT	14,67	Z STA AKL 8 1/8 NPT
8	L	1/4"NPT	Z AKL 8 1/4 NPT	15,50	Z STA AKL 8 1/4 NPT
8	L	3/8"NPT	Z AKL 8 3/8 NPT	17,77	Z STA AKL 8 3/8 NPT
8	L	1/2"NPT	Z AKL 8 1/2 NPT	21,54	Z STA AKL 8 1/2 NPT
10	L	1/4"NPT	Z AKL 10 1/4 NPT	16,16	Z STA AKL 10 1/4 NPT
10	L	3/8"NPT	Z AKL 10 3/8 NPT	17,63	Z STA AKL 10 3/8 NPT
10	L	1/2"NPT	Z AKL 10 1/2 NPT	24,03	Z STA AKL 10 1/2 NPT
12	L	1/4"NPT	Z AKL 12 1/4 NPT	19,96	Z STA AKL 12 1/4 NPT
12	L	3/8"NPT	Z AKL 12 3/8 NPT	20,30	Z STA AKL 12 3/8 NPT
12	L	1/2"NPT	Z AKL 12 1/2 NPT	21,87	Z STA AKL 12 1/2 NPT
15	L	3/8"NPT	Z AKL 15 3/8 NPT	28,02	Z STA AKL 15 3/8 NPT
15	L	1/2"NPT	Z AKL 15 1/2 NPT	29,09	Z STA AKL 15 1/2 NPT
18	L	1/2"NPT	Z AKL 18 1/2 NPT	35,39	Z STA AKL 18 1/2 NPT
18	L	3/4"NPT	Z AKL 18 3/4 NPT	38,11	Z STA AKL 18 3/4 NPT
22	L	3/4"NPT	Z AKL 22 3/4 NPT	40,39	Z STA AKL 22 3/4 NPT
28	L	1"NPT	Z AKL 28 1 NPT	62,15	Z STA AKL 28 1 NPT
35	L	1"1/4NPT	Z AKL 35 1 1/4 NPT	82,54	Z STA AKL 35 1 1/4 NPT
42	L	1"1/2NPT	Z AKL 42 1 1/2 NPT	129,56	Z STA AKL 42 1 1/2 NPT
6	S	1/8"NPT	Z AKS 6 1/8 NPT	20,66	Z STA AKS 6 1/8 NPT
6	S	1/4"NPT	Z AKS 6 1/4 NPT	20,96	Z STA AKS 6 1/4 NPT
6	S	3/8"NPT	Z AKS 6 3/8 NPT	26,01	Z STA AKS 6 3/8 NPT
8	S	1/4"NPT	Z AKS 8 1/4 NPT	18,16	Z STA AKS 8 1/4 NPT
8	S	3/8"NPT	Z AKS 8 3/8 NPT	28,16	Z STA AKS 8 3/8 NPT
8	S	1/2"NPT	Z AKS 8 1/2 NPT	29,42	Z STA AKS 8 1/2 NPT
10	S	1/4"NPT	Z AKS 10 1/4 NPT	21,57	Z STA AKS 10 1/4 NPT
10	S	3/8"NPT	Z AKS 10 3/8 NPT	21,22	Z STA AKS 10 3/8 NPT
10	S	1/2"NPT	Z AKS 10 1/2 NPT	33,10	Z STA AKS 10 1/2 NPT
12	S	1/4"NPT	Z AKS 12 1/4 NPT	28,30	Z STA AKS 12 1/4 NPT
12	S	3/8"NPT	Z AKS 12 3/8 NPT	25,90	Z STA AKS 12 3/8 NPT
12	S	1/2"NPT	Z AKS 12 1/2 NPT	26,78	Z STA AKS 12 1/2 NPT
14	S	1/2"NPT	Z AKS 14 1/2 NPT	34,63	Z STA AKS 14 1/2 NPT
16	S	1/2"NPT	Z AKS 16 1/2 NPT	36,25	Z STA AKS 16 1/2 NPT
16	S	3/4"NPT	Z AKS 16 3/4 NPT	58,45	Z STA AKS 16 3/4 NPT
20	S	1/2"NPT	Z AKS 20 1/2 NPT	43,91	Z STA AKS 20 1/2 NPT
20	S	3/4"NPT	Z AKS 20 3/4 NPT	58,20	Z STA AKS 20 3/4 NPT
20	S	1"NPT	Z AKS 20 1 NPT	62,11	Z STA AKS 20 1 NPT
25	S	3/4"NPT	Z AKS 25 3/4 NPT	85,50	Z STA AKS 25 3/4 NPT
25	S	1"NPT	Z AKS 25 1 NPT	83,02	Z STA AKS 25 1 NPT
30	S	1"NPT	Z AKS 30 1 NPT	115,34	Z STA AKS 30 1 NPT
30	S	1"1/4NPT	Z AKS 30 1 1/4 NPT	117,16	Z STA AKS 30 1 1/4 NPT
38	S	1"1/2NPT	Z AKS 38 1 1/2 NPT	150,23	Z STA AKS 38 1 1/2 NPT

Racor recto rosca cónica BSPT

Straight male stud coupling BSPT

Raccord union simple mâle conique

Raccordo di estremità diritto conico BSPT



TUBO PIPE	SERIE SERIES	ROSCA THREAD	Referencia Part n°	€	Referencia STA Part N° STA
6	LL	1/8" BSPT	Z AKLL 6 R 1/8	*	----
8	LL	1/8" BSPT	Z AKLL 8 R 1/8	*	----
6	L	1/8" BSPT	Z AKL 6 R 1/8	13,26	Z STA AKL 6 R 1/8
6	L	1/4" BSPT	Z AKL 6 R 1/4	14,75	Z STA AKL 6 R 1/4
8	L	1/8" BSPT	Z AKL 8 R 1/8	16,38	Z STA AKL 8 R 1/8
8	L	1/4" BSPT	Z AKL 8 R 1/4	15,33	Z STA AKL 8 R 1/4
6	L	3/8" BSPT	Z AKL 6 R 3/8	21,87	Z STA AKL 6 R 3/8
8	L	3/8" BSPT	Z AKL 8 R 3/8	18,53	Z STA AKL 8 R 3/8
10	L	1/4" BSPT	Z AKL 10 R 1/4	15,67	Z STA AKL 10 R 1/4
10	L	3/8" BSPT	Z AKL 10 R 3/8	15,29	Z STA AKL 10 R 3/8
10	L	1/2" BSPT	Z AKL 10 R 1/2	20,21	Z STA AKL 10 R 1/2
12	L	1/4" BSPT	Z AKL 12 R 1/4	18,23	Z STA AKL 12 R 1/4
12	L	3/8" BSPT	Z AKL 12 R 3/8	18,35	Z STA AKL 12 R 3/8
12	L	1/2" BSPT	Z AKL 12 R 1/2	20,75	Z STA AKL 12 R 1/2
15	L	3/8" BSPT	Z AKL 15 R 3/8	27,05	Z STA AKL 15 R 3/8
15	L	1/2" BSPT	Z AKL 15 R 1/2	25,18	Z STA AKL 15 R 1/2
18	L	1/2" BSPT	Z AKL 18 R 1/2	29,29	Z STA AKL 18 R 1/2
22	L	3/4" BSPT	Z AKL 22 R 3/4	37,54	Z STA AKL 22 R 3/4
28	L	1" BSPT	Z AKL 28 R 1	62,40	Z STA AKL 28 R 1
35	L	1"1/4 BSPT	Z AKL 35 R 1 1/4	83,00	Z STA AKL 35 R 1 1/4
42	L	1"1/4 BSPT	Z AKL 42 R 1 1/4	121,15	Z STA AKL 42 R 1 1/4
6	S	1/4" BSPT	Z AKS 6 R 1/4	17,81	Z STA AKS 6 R 1/4
8	S	1/4" BSPT	Z AKS 8 R 1/4	17,18	Z STA AKS 8 R 1/4
10	S	3/8" BSPT	Z AKS 10 R 3/8	30,40	Z STA AKS 10 R 3/8
14	S	1/2" BSPT	Z AKS 14 R 1/2	55,22	Z STA AKS 14 R 1/2
16	S	1/2" BSPT	Z AKS 16 R 1/2	33,98	Z STA AKS 16 R 1/2
20	S	3/4" BSPT	Z AKS 20 R 3/4	48,26	Z STA AKS 20 R 3/4
25	S	1" BSPT	Z AKS 25 R 1	84,33	Z STA AKS 25 R 1
30	S	1"1/4 BSPT	Z AKS 30 R 1 1/4	202,69	Z STA AKS 30 R 1 1/4

Racor recto rosca cónica Métrica

Straight male stud coupling Metric

Raccord union simple mâle Métrique conique

Raccordo di estremità diritto Metrico conico



TUBO PIPE	SERIE SERIES	ROSCA THREAD	Referencia Part n°
6	LL	M10X1	Z AKLL 6 M10X1
6	L	M10X1	Z AKL 6 M 10X1
8	L	M12X1,5	Z AKL 8 M 12X1,5
10	L	M14X1,5	Z AKL 10 M 14X1,5
12	L	M16X1,5	Z AKL 12 M 16X1,5
15	L	M18X1,5	Z AKL 15 M 18X1,5
18	L	M22X1,5	Z AKL 18 M 22X1,5
22	L	M26X1,5	Z AKL 22 M 26X1,5

Racores DIN 2353

DIN 2353 Pipe fittings
Raccords à bague DIN 2353
Raccordi DIN 2353

Racor en codo rosca cónica BSPT

Male stud elbow BSPT

Raccord union coude mâle gaz conique

Raccordo di estremità 90º conico BSPT



Racor en codo rosca cónica NPT

Male stud elbow NPT

Raccord union coude mâle NPT

Raccordo di estremità 90º conico NPT



TUBO PIPE	SERIE SERIES	ROSCA THREAD	Referencia Part n°	€	Referencia STA Part N° STA
6	LL	1/8" BSPT	Z CKLL 6 R 1/8	21,67	---
6	L	1/8" BSPT	Z CKL 6 R 1/8	18,98	Z STA CKL 6 R 1/8
6	L	1/4" BSPT	Z CKL 6 R 1/4	18,49	Z STA CKL 6 R 1/4
8	L	1/8" BSPT	Z CKL 8 R 1/8	22,12	Z STA CKL 8 R 1/8
8	L	1/4" BSPT	Z CKL 8 R 1/4	21,17	Z STA CKL 8 R 1/4
8	L	3/8" BSPT	Z CKL 8 R 3/8	27,70	Z STA CKL 8 R 3/8
8	L	1/2" BSPT	Z CKL 8 R 1/2	36,42	Z STA CKL 8 R 1/2
10	L	1/8" BSPT	Z CKL 10 R 1/8	32,59	Z STA CKL 10 R 1/8
10	L	1/4" BSPT	Z CKL 10 R 1/4	22,52	Z STA CKL 10 R 1/4
10	L	3/8" BSPT	Z CKL 10 R 3/8	26,77	Z STA CKL 10 R 3/8
10	L	1/2" BSPT	Z CKL 10 R 1/2	26,55	Z STA CKL 10 R 1/2
12	L	1/4" BSPT	Z CKL 12 R 1/4	26,48	Z STA CKL 12 R 1/4
12	L	3/8" BSPT	Z CKL 12 R 3/8	27,28	Z STA CKL 12 R 3/8
12	L	1/2" BSPT	Z CKL 12 R 1/2	32,50	Z STA CKL 12 R 1/2
15	L	3/8" BSPT	Z CKL 15 R 3/8	45,30	Z STA CKL 15 R 3/8
15	L	1/2" BSPT	Z CKL 15 R 1/2	37,51	Z STA CKL 15 R 1/2
18	L	1/2" BSPT	Z CKL 18 R 1/2	47,43	Z STA CKL 18 R 1/2
22	L	3/4" BSPT	Z CKL 22 R 3/4	80,74	Z STA CKL 22 R 3/4
28	L	1" BSPT	Z CKL 28 R 1	160,44	Z STA CKL 28 R 1
35	L	1 1/4" BSPT	Z CKL 35 R 1 1/4	278,98	Z STA CKL 35 R 1 1/4
6	S	1/4" BSPT	Z CKS 6 R 1/4	26,20	Z STA CKS 6 R 1/4
8	S	1/4" BSPT	Z CKS 8 R 1/4	28,72	Z STA CKS 8 R 1/4
8	S	3/8" BSPT	Z CKS 8 R 3/8*	48,25	---
8	S	1/2" BSPT	Z CKS 8 R 1/2	34,51	Z STA CKS 8 R 1/2
10	S	1/4" BSPT	Z CKS 10 R 1/4	36,98	Z STA CKS 10 R 1/4
10	S	3/8" BSPT	Z CKS 10 R 3/8	32,03	Z STA CKS 10 R 3/8
10	S	1/2" BSPT	Z CKS 10 R 1/2*	50,89	---
12	S	3/8" BSPT	Z CKS 12 R 3/8	37,78	Z STA CKS 12 R 3/8
14	S	1/2" BSPT	Z CKS 14 R 1/2	46,63	Z STA CKS 14 R 1/2
16	S	1/2" BSPT	Z CKS 16 R 1/2	55,56	Z STA CKS 16 R 1/2
20	S	3/4" BSPT	Z CKS 20 R 3/4	86,33	Z STA CKS 20 R 3/4
25	S	1" BSPT	Z CKS 25 R 1	158,60	Z STA CKS 25 R 1
30	S	1 1/4" BSPT	Z CKS 30 R 1 1/4	309,05	Z STA CKS 30 R 1 1/4
38	S	1 1/2" BSPT	Z CKS 38 R 1 1/2	413,96	Z STA CKS 38 R 1 1/2

* Hasta fin de existencias / Until end of stock / Jusqu'à la fin du stock / Fino ad esaurimento

Racor en codo orientable BSP

90º Adjustable male stud elbow BSP

Coude orientable mâle BSP

Raccordo di estremità 90º orientabile BSP



TUBO PIPE	SERIE SERIES	ROSCA THREAD	Referencia Part n°	€	Referencia STA Part N° STA
6	L	1/8" BSP	Z WEE 6L R 1/8	24,15	Z STA WEE 6L R 1/8
8	L	1/4" BSP	Z WEE 8L R 1/4	33,35	Z STA WEE 8L R 1/4
10	L	1/4" BSP	Z WEE 10L R 1/4	35,88	Z STA WEE 10L R 1/4
12	L	3/8" BSP	Z WEE 12L R 3/8	47,64	Z STA WEE 12L R 3/8
15	L	1/2" BSP	Z WEE 15L R 1/2	88,92	Z STA WEE 15L R 1/2
18	L	1/2" BSP	Z WEE 18L R 1/2	93,97	Z STA WEE 18L R 1/2
22	L	3/4" BSP	Z WEE 22L R 3/4	147,68	Z STA WEE 22L R 3/4
6	S	1/4" BSP	Z WEE 6S R 1/4	27,26	Z STA WEE 6S R 1/4
8	S	1/4" BSP	Z WEE 8S R 1/4	38,29	Z STA WEE 8S R 1/4
10	S	3/8" BSP	Z WEE 10S R 3/8	51,97	Z STA WEE 10S R 3/8
12	S	3/8" BSP	Z WEE 12S R 3/8	63,25	Z STA WEE 12S R 3/8
16	S	1/2" BSP	Z WEE 16S R 1/2	102,38	Z STA WEE 16S R 1/2
20	S	3/4" BSP	Z WEE 20S R 3/4	125,52	Z STA WEE 20S R 3/4
25	S	1" BSP	Z WEE 25S R 1	241,76	Z STA WEE 25S R 1

Racor en codo rosca cónica Métrica

Male stud elbow metrical conical

Raccord équerre mâle métrique

Raccordo di estremità a 90º Metrico conico



TUBO PIPE	SERIE SERIES	ROSCA THREAD	Referencia Part n°
6	L	M10X1	Z CKL 6 M 10X1
8	L	M12X1.5	Z CKL 8 M 12X1.5
10	L	M14X1.5	Z CKL 10 M 14X1.5
12	L	M16X1.5	Z CKL 12 M 16X1.5
15	L	M18X1.5	Z CKL 15 M 18X1.5
18	L	M22X1.5	Z CKL 18 M 22X1.5
6	S	M12X1.5	Z CKS 6 M 12X1.5
8	S	M14X1.5	Z CKS 8 M 14X1.5
10	S	M16X1.5	Z CKS 10 M 16X1.5
12	S	M18X1.5	Z CKS 12 M 18X1.5
14	S	M20X1.5	Z CKS 14 M 20X1.5
16	S	M22X1.5	Z CKS 16 M 22X1.5

Racores DIN 2353

DIN 2353 Pipe fittings
Raccords à bague DIN 2353
Raccordi DIN 2353

Racor en L rosca cónica BSPT

Male stud barrel TEE BSPT

Raccord TÉ mâle gaz conique latéral

Raccordo di estremità a L conico BSPT



TUBO PIPE	SERIE SERIES	ROSCA THREAD	Referencia Part n°
6	L	1/8" BSPT	Z LKL 6 R 1/8
8	L	1/4" BSPT	Z LKL 8 R 1/4
10	L	1/4" BSPT	Z LKL 10 R 1/4
12	L	3/8" BSPT	Z LKL 12 R 3/8
15	L	1/2" BSPT	Z LKL 15 R 1/2
18	L	1/2" BSPT	Z LKL 18 R 1/2
6	S	1/4" BSPT	Z LKS 6 R 1/4
8	S	1/4" BSPT	Z LKS 8 R 1/4
10	S	3/8" BSPT	Z LKS 10 R 3/8
12	S	3/8" BSPT	Z LKS 12 R 3/8
14	S	1/2" BSPT	Z LKS 14 R 1/2
16	S	1/2" BSPT	Z LKS 16 R 1/2

Racor en L rosca cónica Métrica

Male stud barrel TEE Metric

Raccord Té mâle Métrique latéral

Raccordo di estremità a L Metrico conico



TUBO PIPE	SERIE SERIES	ROSCA THREAD	Referencia Part n°	€
6	L	M10X1	Z LKL 6 M 10X1	*
8	L	M12X1.5	Z LKL 8 M 12X1.5	*
10	L	M14X1.5	Z LKL 10 M 14X1.5	*
12	L	M16X1.5	Z LKL 12 M 16X1.5	*
15	L	M18X1.5	Z LKL 15 M 18X1.5	*
18	L	M22X1.5	Z LKL 18 M 22X1.5	*
6	S	M12X1.5	Z LKS 6 M 12X1.5	*
8	S	M14X1.5	Z LKS 8 M 14X1.5	*
10	S	M16X1.5	Z LKS 10 M 16X1.5	*
12	S	M18X1.5	Z LKS 12 M 18X1.5	*
14	S	M20X1.5	Z LKS 14 M 20X1.5	*
16	S	M22X1.5	Z LKS 16 M 22X1.5	*

Racor en T rosca cónica BSPT

Male stud branch TEE BSPT

Raccord TÉ mâle gaz conique au centre

Raccordo di estremità a T conico BSPT



TUBO PIPE	SERIE SERIES	ROSCA THREAD	Referencia Part n°
6	L	1/8" BSPT	Z FKL 6 R 1/8
8	L	1/8" BSPT	Z FKL 8 R 1/8*
8	L	1/4" BSPT	Z FKL 8 R 1/4
10	L	1/4" BSPT	Z FKL 10 R 1/4
12	L	3/8" BSPT	Z FKL 12 R 3/8
15	L	1/2" BSPT	Z FKL 15 R 1/2
18	L	1/2" BSPT	Z FKL 18 R 1/2
6	S	1/4" BSPT	Z FKS 6 R 1/4
8	S	1/4" BSPT	Z FKS 8 R 1/4
10	S	3/8" BSPT	Z FKS 10 R 3/8
12	S	3/8" BSPT	Z FKS 12 R 3/8
14	S	1/2" BSPT	Z FKS 14 R 1/2

*Hasta fin de existencias / Until end of stock / Jusqu'à la fin du stock / Fino ad esaurimento

Racor en T rosca cónica Métrica

Male stud branch TEE Metric

Raccord TÉ mâle Métrique au centre

Raccordo di estremità a T Metrico conico



TUBO PIPE	SERIE SERIES	ROSCA THREAD	Referencia Part n°	€
6	L	M10X1	Z FKL 6 M 10X1	*
8	L	M12X1.5	Z FKL 8 M 12X1.5	*
10	L	M14X1.5	Z FKL 10 M 14X1.5	*
12	L	M16X1.5	Z FKL 12 M 16X1.5	*
15	L	M18X1.5	Z FKL 15 M 18X1.5	*
6	S	M12X1.5	Z FKS 6 M 12X1.5	*
8	S	M14X1.5	Z FKS 8 M 14X1.5	*
10	S	M16X1.5	Z FKS 10 M 16X1.5	*
12	S	M18X1.5	Z FKS 12 M 18X1.5	*
14	S	M20X1.5	Z FKS 14 M 20X1.5	*
16	S	M22X1.5	Z FKS 16 M 22X1.5	*

Racores DIN 2353

DIN 2353 Pipe fittings
Raccords à bague DIN 2353
Raccordi DIN 2353

Racor de reducci3n con TL M3trica (serie ligera)

Standpipe reducer swivel female (light series)

Raccord union simple femelle tournante M3trique (s3rie l3g3re)

Raccordo di riduzione con dado pre-montato (serie leggera L)



Racor de reducci3n con TL M3trica (serie pesada)

Standpipe reducer swivel female (heavy series)

Raccord union simple femelle tournante M3trique (s3rie lourde)

Raccordo di riduzione con dado pre-montato (serie pesante S)



TUBO PIPE	PIPE	SERIE SERIES	Referencia Part n°	€	Referencia Part n°
8	6	L	Z KORL 8-6 TLM	27,03	Z STA KORL 8-6 TLM
10	6	L	Z KORL 10-6 TLM	27,36	Z STA KORL 10-6 TLM
10	8	L	Z KORL 10-8 TLM	24,54	Z STA KORL 10-8 TLM
12	6	L	Z KORL 12-6 TLM	32,85	Z STA KORL 12-6 TLM
12	8	L	Z KORL 12-8 TLM	24,44	Z STA KORL 12-8 TLM
12	10	L	Z KORL 12-10 TLM	29,51	Z STA KORL 12-10 TLM
15	6	L	Z KORL 15-6 TLM	39,11	Z STA KORL 15-6 TLM
15	8	L	Z KORL 15-8 TLM	33,95	Z STA KORL 15-8 TLM
15	10	L	Z KORL 15-10 TLM	37,12	Z STA KORL 15-10 TLM
15	12	L	Z KORL 15-12 TLM	28,80	Z STA KORL 15-12 TLM
18	8	L	Z KORL 18-8 TLM	43,85	Z STA KORL 18-8 TLM
18	10	L	Z KORL 18-10 TLM	37,22	Z STA KORL 18-10 TLM
18	12	L	Z KORL 18-12 TLM	39,36	Z STA KORL 18-12 TLM
18	15	L	Z KORL 18-15 TLM	44,93	Z STA KORL 18-15 TLM
22	10	L	Z KORL 22-10 TLM	41,05	Z STA KORL 22-10 TLM
22	12	L	Z KORL 22-12 TLM	40,70	Z STA KORL 22-12 TLM
22	15	L	Z KORL 22-15 TLM	46,42	Z STA KORL 22-15 TLM
22	18	L	Z KORL 22-18 TLM	54,60	Z STA KORL 22-18 TLM
28	10	L	Z KORL 28-10 TLM	72,44	Z STA KORL 28-10 TLM
28	12	L	Z KORL 28-12 TLM	61,15	Z STA KORL 28-12 TLM
28	15	L	Z KORL 28-15 TLM	92,41	Z STA KORL 28-15 TLM
28	18	L	Z KORL 28-18 TLM	60,51	Z STA KORL 28-18 TLM
28	22	L	Z KORL 28-22 TLM	67,35	Z STA KORL 28-22 TLM
35	12	L	Z KORL 35-12 TLM	100,15	Z STA KORL 35-12 TLM
35	22	L	Z KORL 35-22 TLM	110,23	Z STA KORL 35-22 TLM
35	28	L	Z KORL 35-28 TLM	97,00	Z STA KORL 35-28 TLM
42	22	L	Z KORL 42-22 TLM	186,89	Z STA KORL 42-22 TLM
42	28	L	Z KORL 42-28 TLM	137,80	Z STA KORL 42-28 TLM
42	35	L	Z KORL 42-35 TLM	141,47	Z STA KORL 42-35 TLM

TUBO PIPE	PIPE	SERIE SERIES	Referencia Part n°	€	Referencia Part n°
8	6	S	Z KORS 8-6 TLM	43,10	Z STA KORS 8-6 TLM
10	6	S	Z KORS 10-6 TLM	46,50	Z STA KORS 10-6 TLM
10	8	S	Z KORS 10-8 TLM	46,28	Z STA KORS 10-8 TLM
12	6	S	Z KORS 12-6 TLM	46,97	Z STA KORS 12-6 TLM
12	8	S	Z KORS 12-8 TLM	42,99	Z STA KORS 12-8 TLM
12	10	S	Z KORS 12-10 TLM	50,92	Z STA KORS 12-10 TLM
14	10	S	Z KORS 14-10 TLM	56,15	Z STA KORS 14-10 TLM
14	12	S	Z KORS 14-12 TLM	55,41	Z STA KORS 14-12 TLM
16	6	S	Z KORS 16-6 TLM	66,26	Z STA KORS 16-6 TLM
16	8	S	Z KORS 16-8 TLM	64,77	Z STA KORS 16-8 TLM
16	10	S	Z KORS 16-10 TLM	62,24	Z STA KORS 16-10 TLM
16	12	S	Z KORS 16-12 TLM	48,07	Z STA KORS 16-12 TLM
20	8	S	Z KORS 20-8 TLM	81,64	Z STA KORS 20-8 TLM
20	10	S	Z KORS 20-10 TLM	81,71	Z STA KORS 20-10 TLM
20	12	S	Z KORS 20-12 TLM	60,39	Z STA KORS 20-12 TLM
20	14	S	Z KORS 20-14 TLM	82,70	Z STA KORS 20-14 TLM
20	16	S	Z KORS 20-16 TLM	70,50	Z STA KORS 20-16 TLM
25	12	S	Z KORS 25-12 TLM	103,23	Z STA KORS 25-12 TLM
25	16	S	Z KORS 25-16 TLM	109,85	Z STA KORS 25-16 TLM
25	20	S	Z KORS 25-20 TLM	119,04	Z STA KORS 25-20 TLM
30	16	S	Z KORS 30-16 TLM	151,97	Z STA KORS 30-16 TLM
30	20	S	Z KORS 30-20 TLM	133,51	Z STA KORS 30-20 TLM
30	25	S	Z KORS 30-25 TLM	174,85	Z STA KORS 30-25 TLM
38	20	S	Z KORS 38-20 TLM	170,85	Z STA KORS 38-20 TLM
38	25	S	Z KORS 38-25 TLM	193,18	Z STA KORS 38-25 TLM
38	30	S	Z KORS 38-30 TLM	251,18	Z STA KORS 38-30 TLM

Racores DIN 2353

DIN 2353 Pipe fittings
Raccords à bague DIN 2353
Raccordi DIN 2353

Reducción con rosca M-HF BSP con junta plana

Male-female reducing adaptor BSP cylindrical with flat seal

Raccord réduction mâle gaz-fem gaz avec joint plat

Riduzione filettata maschio con guarnizione piana - femmina BSP



ROSCA (H) THREAD (F)	ROSCA (M) THREAD (M)	Referencia Part n°
1/4" BSP	1/8" BSP	Z RI-R 1/8 R 1/4WD
1/8" BSP	1/4" BSP	Z RI-R 1/4 R 1/8WD
3/8" BSP	1/4" BSP	Z RI-R 1/4 R 3/8WD
1/2" BSP	1/4" BSP	Z RI-R 1/4 R 1/2WD
1/8" BSP	3/8" BSP	Z RI-R 3/8 R 1/8WD
1/4" BSP	3/8" BSP	Z RI-R 3/8 R 1/4WD
1/2" BSP	3/8" BSP	Z RI-R 3/8 R 1/2WD
3/4" BSP	3/8" BSP	Z RI-R 3/8 R 3/4WD
1/8" BSP	1/2" BSP	Z RI-R 1/2 R 1/8WD
1/4" BSP	1/2" BSP	Z RI-R 1/2 R 1/4WD
3/8" BSP	1/2" BSP	Z RI-R 1/2 R 3/8WD
3/4" BSP	1/2" BSP	Z RI-R 1/2 R 3/4WD
1/4" BSP	3/4" BSP	Z RI-R 3/4 R 1/4WD
3/8" BSP	3/4" BSP	Z RI-R 3/4 R 3/8WD
1/2" BSP	3/4" BSP	Z RI-R 3/4 R 1/2WD
1" BSP	3/4" BSP	Z RI-R 3/4 R 1WD
1/4" BSP	1" BSP	Z RI-R 1 R 1/4WD
3/8" BSP	1" BSP	Z RI-R 1 R 3/8WD
1/2" BSP	1" BSP	Z RI-R 1 R 1/2WD
3/4" BSP	1" BSP	Z RI-R 1 R 3/4WD
1" 1/4 BSP	1" BSP	Z RI-R 1 R 1 1/4WD
1/2" BSP	1" 1/4 BSP	Z RI-R 1 1/4 R 1/2WD
3/4" BSP	1" 1/4 BSP	Z RI-R 1 1/4 R 3/4WD
1" BSP	1" 1/4 BSP	Z RI-R 1 1/4 R 1WD
1" 1/2 BSP	1" 1/4 BSP	Z RI-R 1 1/4 R 1 1/2WD
1/2" BSP	1" 1/2 BSP	Z RI-R 1 1/2 R 1/2WD
3/4" BSP	1" 1/2 BSP	Z RI-R 1 1/2 R 3/4WD
1" BSP	1" 1/2 BSP	Z RI-R 1 1/2 R 1WD
1" 1/4 BSP	1" 1/2 BSP	Z RI-R 1 1/2 R 1 1/4WD
2" BSP	1" 1/2 BSP	Z RI-R 1 1/2 R 2WD
1" 1/2 BSP	2" BSP	Z RI-R 2 R 1 1/2WD

CRIMPING FITTINGS
FOR HOSES

PIPE
FITTINGS

PIPE
FITTINGS II

ADAPTORS

WELDING
FITTINGS

INDUSTRIAL
FITTINGS

ACCESSORIES

CONTROL
COMPONENTS

FLOW
MEASURING

TRALLE LOK

Racores DIN 2353

DIN 2353 Pipe fittings
Raccords à bague DIN 2353
Raccordi DIN 2353

Racor en codo regulable con tuerca y anillo

Adjustable stud elbow with nut and ring

Raccord coude orientable tube lisse équipé

Raccordo orientabile a 90° con dado e anello



TUBO PIPE	SERIE SERIES	Referencia Part n°	€	Referencia STA Part N° STA
6	L	Z EEL 6 CTA	26,95	Z STA EEL 6 CTA
15	L	Z EEL 15 CTA	49,49	Z STA EEL 15 CTA
35	L	Z EEL 35 CTA	179,35	Z STA EEL 35 CTA
6	S	Z EES 6 CTA	25,47	Z STA EES 6 CTA
16	S	Z EES 16 CTA	58,57	Z STA EES 16 CTA

Hasta fin de existencias / Until end of stock / Jusqu'à la fin du stock / Fino ad esaurimento

Racor en codo regulable TL Métrica

Adjustable stud elbow with o'ring

Raccord coude orientable Métrique avec o'ring

Raccordo orientabile a 90° con o'ring (dado spinato)



TUBO PIPE	SERIE SERIES	Referencia Part n°	€	Referencia STA Part N° STA
6	L	Z EEL 6 TLM	26,23	Z STA EEL 6 TLM
8	L	Z EEL 8 TLM	28,01	Z STA EEL 8 TLM
10	L	Z EEL 10 TLM	28,92	Z STA EEL 10 TLM
12	L	Z EEL 12 TLM	36,44	Z STA EEL 12 TLM
15	L	Z EEL 15 TLM	48,70	Z STA EEL 15 TLM
18	L	Z EEL 18 TLM	67,55	Z STA EEL 18 TLM
22	L	Z EEL 22 TLM	86,94	Z STA EEL 22 TLM
28	L	Z EEL 28 TLM	129,95	Z STA EEL 28 TLM
35	L	Z EEL 35 TLM	177,92	Z STA EEL 35 TLM
42	L	Z EEL 42 TLM	382,34	Z STA EEL 42 TLM
6	S	Z EES 6 TLM	38,25	Z STA EES 6 TLM
8	S	Z EES 8 TLM	39,06	Z STA EES 8 TLM
10	S	Z EES 10 TLM	40,44	Z STA EES 10 TLM
12	S	Z EES 12 TLM	52,23	Z STA EES 12 TLM
14	S	Z EES 14 TLM	66,22	Z STA EES 14 TLM
16	S	Z EES 16 TLM	65,68	Z STA EES 16 TLM
20	S	Z EES 20 TLM	95,44	Z STA EES 20 TLM
25	S	Z EES 25 TLM	161,46	Z STA EES 25 TLM
30	S	Z EES 30 TLM	213,16	Z STA EES 30 TLM
38	S	Z EES 38 TLM	346,58	Z STA EES 38 TLM

Racor en T regulable TL Métrica

Adjustable stud branch TEE with o'ring

Raccord TÉ orientable Métrique avec o'ring

Raccordo orientabile a T con o'ring (dado spinato)



TUBO PIPE	SERIE SERIES	Referencia Part n°	€	Referencia STA Part N° STA
6	L	Z TEL 6 TLM	34,48	Z STA TEL 6 TLM
8	L	Z TEL 8 TLM	37,10	Z STA TEL 8 TLM
10	L	Z TEL 10 TLM	40,29	Z STA TEL 10 TLM
12	L	Z TEL 12 TLM	47,19	Z STA TEL 12 TLM
15	L	Z TEL 15 TLM	70,87	Z STA TEL 15 TLM
18	L	Z TEL 18 TLM	121,76	Z STA TEL 18 TLM
22	L	Z TEL 22 TLM	138,10	Z STA TEL 22 TLM
28	L	Z TEL 28 TLM	195,68	Z STA TEL 28 TLM
35	L	Z TEL 35 TLM	339,18	Z STA TEL 35 TLM
42	L	Z TEL 42 TLM	441,68	Z STA TEL 42 TLM
6	S	Z TES 6 TLM	53,69	Z STA TES 6 TLM
8	S	Z TES 8 TLM	48,55	Z STA TES 8 TLM
10	S	Z TES 10 TLM	56,51	Z STA TES 10 TLM
12	S	Z TES 12 TLM	60,52	Z STA TES 12 TLM
14	S	Z TES 14 TLM	96,74	Z STA TES 14 TLM
16	S	Z TES 16 TLM	108,44	Z STA TES 16 TLM
20	S	Z TES 20 TLM	139,71	Z STA TES 20 TLM
25	S	Z TES 25 TLM	225,84	Z STA TES 25 TLM
30	S	Z TES 30 TLM	311,23	Z STA TES 30 TLM
38	S	Z TES 38 TLM	467,64	Z STA TES 38 TLM

Racor en T regulable TL Métrica

Adjustable stud barrel TEE with o'ring

Raccord TÉ orientable renversé Métrique avec o'ring

Raccordo orientabile a T con o'ring (dado spinato)



TUBO PIPE	SERIE SERIES	ROSCA THREAD	Referencia Part n°	€	Referencia STA Part N° STA
6	L	M12X1,5	Z LEL 6 TLM	33,31	Z STA LEL 6 TLM
8	L	M14X1,5	Z LEL 8 TLM	52,04	Z STA LEL 8 TLM
10	L	M16X1,5	Z LEL 10 TLM	45,48	Z STA LEL 10 TLM
12	L	M18X1,5	Z LEL 12 TLM	56,19	Z STA LEL 12 TLM
15	L	M22X1,5	Z LEL 15 TLM	77,75	Z STA LEL 15 TLM
18	L	M26X1,5	Z LEL 18 TLM	100,22	Z STA LEL 18 TLM
22	L	M30X2	Z LEL 22 TLM	144,60	Z STA LEL 22 TLM
28	L	M36X2	Z LEL 28 TLM	197,01	Z STA LEL 28 TLM
35	L	M45X2	Z LEL 35 TLM	352,62	Z STA LEL 35 TLM
42	L	M52X2	Z LEL 42 TLM	469,25	Z STA LEL 42 TLM
6	S	M14X1,5	Z LES 6 TLM	43,10	Z STA LES 6 TLM
8	S	M16X1,5	Z LES 8 TLM	54,90	Z STA LES 8 TLM
10	S	M18X1,5	Z LES 10 TLM	72,07	Z STA LES 10 TLM
12	S	M20X1,5	Z LES 12 TLM	64,43	Z STA LES 12 TLM
14	S	M22X1,5	Z LES 14 TLM	103,19	Z STA LES 14 TLM
16	S	M24X1,5	Z LES 16 TLM	109,93	Z STA LES 16 TLM
20	S	M30X2	Z LES 20 TLM	144,42	Z STA LES 20 TLM
25	S	M36X2	Z LES 25 TLM	241,58	Z STA LES 25 TLM
30	S	M42X2	Z LES 30 TLM	333,34	Z STA LES 30 TLM
38	S	M52X2	Z LES 38 TLM	488,66	Z STA LES 38 TLM

Racores DIN 2353

DIN 2353 Pipe fittings
Raccords à bague DIN 2353
Raccordi DIN 2353

Racor unión TL Métrica

Straight connection with o'ring

Raccord union tournante Métrique égale

Raccordo diritto intermedio con o'ring e dadi spinati



TUBO PIPE	SERIE SERIES	Referencia Part n°
6	L	Z ATL 6
8	L	Z ATL 8
10	L	Z ATL 10
12	L	Z ATL 12
15	L	Z ATL 15
18	L	Z ATL 18
22	L	Z ATL 22
28	L	Z ATL 28
35	L	Z ATL 35
42	L	Z ATL 42
6	S	Z ATS 6
8	S	Z ATS 8
10	S	Z ATS 10
12	S	Z ATS 12
14	S	Z ATS 14
16	S	Z ATS 16
20	S	Z ATS 20
25	S	Z ATS 25
30	S	Z ATS 30
38	S	Z ATS 38

Racor recto macho BSP con junta plana - TLM

Straight stud standpipe adaptor with captive seal
BSP cylindrical-metric swivel fem.

Raccord adapt.tube lisse-mâle gaz BSP avec joint
plat-fem.tourn.métrique

Raccordo di estremità BSP con guarnizione - dado
spinato metrico e o'ring



TUBO PIPE	SERIE SERIES	ROSCA THREAD	Referencia Part n°
6	L	1/8" BSP	Z RAL 6 R 1/8TLMWD
8	L	1/4" BSP	Z RAL 8 R 1/4TLMWD
10	L	1/4" BSP	Z RAL 10 R 1/4TLMWD
12	L	1/4" BSP	Z RAL 12 R 1/4TLMWD
12	L	3/8" BSP	Z RAL 12 R 3/8TLMWD
12	L	1/2" BSP	Z RAL 12 R 1/2TLMWD
15	L	1/2" BSP	Z RAL 15 R 1/2TLMWD
18	L	1/2" BSP	Z RAL 18 R 1/2TLMWD
22	L	3/4" BSP	Z RAL 22 R 3/4TLMWD
28	L	1" BSP	Z RAL 28 R 1TLMWD
35	L	1 1/4" BSP	Z RAL 35 R 1 1/4TLMWD
42	L	1 1/2" BSP	Z RAL 42 R 1 1/2TLMWD
6	S	1/4" BSP	Z RAS 6 R 1/4TLMWD
8	S	1/4" BSP	Z RAS 8 R 1/4TLMWD
10	S	3/8" BSP	Z RAS 10 R 3/8TLMWD
12	S	3/8" BSP	Z RAS 12 R 3/8TLMWD
12	S	1/2" BSP	Z RAS 12 R 1/2TLMWD
14	S	1/2" BSP	Z RAS 14 R 1/2TLMWD
16	S	1/2" BSP	Z RAS 16 R 1/2TLMWD
20	S	3/4" BSP	Z RAS 20 R 3/4TLMWD
25	S	1" BSP	Z RAS 25 R 1TLMWD
30	S	1 1/4" BSP	Z RAS 30 R 1 1/4TLMWD
38	S	1 1/2" BSP	Z RAS 38 R 1 1/2TLMWD

Racor recto macho NPT - TL Metrica

Straight stud standpipe adaptor NPT- metric swivel
fem.

Raccord adapteur tube lisse - mâle NPT- fem.
tourn. métrique

Raccordo di estremità conico NPT - dado spinato
metrico e o'ring



TUBO PIPE	SERIE SERIES	ROSCA THREAD	Referencia Part n°
6	L	1/8" NPT	Z RAL 6 R 1/8 NPTTLM
8	L	1/4" NPT	Z RAL 8 R 1/4 NPTTLM
10	L	1/4" NPT	Z RAL 10 R 1/4 NPTTLM
12	L	3/8" NPT	Z RAL 12 R 3/8 NPTTLM
15	L	1/2" NPT	Z RAL 15 R 1/2 NPTTLM
18	L	1/2" NPT	Z RAL 18 R 1/2 NPTTLM
22	L	3/4" NPT	Z RAL 22 R 3/4 NPTTLM
28	L	1" NPT	Z RAL 28 R 1 NPTTLM
35	L	1 1/4" NPT	Z RAL 35 R 1 1/4 NPTTLM
42	L	1 1/2" NPT	Z RAL 42 R 1 1/2 NPTTLM
6	S	1/4" NPT	Z RAS 6 R 1/4 NPTTLM
8	S	1/4" NPT	Z RAS 8 R 1/4 NPTTLM
10	S	3/8" NPT	Z RAS 10 R 3/8 NPTTLM
12	S	1/4" NPT	Z RAS 12 R 1/4 NPTTLM
14	S	1/2" NPT	Z RAS 14 R 1/2 NPTTLM
16	S	1/2" NPT	Z RAS 16 R 1/2 NPTTLM
20	S	3/4" NPT	Z RAS 20 R 3/4 NPTTLM
25	S	3/4" NPT	Z RAS 25 R 3/4 NPTTLM
25	S	1" NPT	Z RAS 25 R 1 NPTTLM
30	S	1" NPT	Z RAS 30 R 1 NPTTLM
30	S	1 1/4" NPT	Z RAS 30 R 1 1/4 NPTTLM
38	S	1 1/2" NPT	Z RAS 38 R 1 1/2 NPTTLM

Racor recto macho Métrico con junta plana - tubo TLM

Straight stud standpipe adaptor Metric with captive
seal-metric swivel fem.

Raccord adapt.tube lisse-mâle Métrique avec joint
plat-fem.tourn.métrique

Raccordo di estremità metrico con guarnizione -
dado spinato metrico e o'ring



TUBO PIPE	SERIE SERIES	ROSCA THREAD	Referencia Part n°
6	L	M10X1	Z RAL 6M10X1TLMWD
8	L	M12X1.5	Z RAL 8M12X1.5TLMWD
10	L	M14X1.5	Z RAL 10M14X1.5TLMWD
12	L	M16X1.5	Z RAL 12M16X1.5TLMWD
15	L	M18X1.5	Z RAL 15M18X1.5TLMWD
18	L	M22X1.5	Z RAL 18M22X1.5TLMWD
22	L	M26X1.5	Z RAL 22M26X1.5TLMWD
28	L	M33X2	Z RAL 28M33X2TLMWD
35	L	M42X2	Z RAL 35M42X2TLMWD
42	L	M48X2	Z RAL 42M48X2TLMWD
6	S	M12X1.5	Z RAS 6M12X1.5TLMWD
8	S	M14X1.5	Z RAS 8M14X1.5TLMWD
10	S	M16X1.5	Z RAS 10M16X1.5TLMWD
12	S	M18X1.5	Z RAS 12M18X1.5TLMWD
14	S	M20X1.5	Z RAS 14M20X1.5TLMWD
16	S	M22X1.5	Z RAS 16M22X1.5TLMWD
20	S	M27X2	Z RAS 20M27X2TLMWD
25	S	M33X2	Z RAS 25M33X2TLMWD
30	S	M42X2	Z RAS 30M42X2TLMWD
38	S	M48X2	Z RAS 38M48X2TLMWD

Racores DIN 2353

DIN 2353 Pipe fittings
Raccords à bague DIN 2353
Raccordi DIN 2353

Racor recto para soldar

Weldable straight coupling

Raccord mamelon hexagonal Métrique
à souder

Raccordo diritto a saldare



Boquilla para soldar

Welding nipple with o-ring

Raccord collet cône métrique à souder

Ogiva a saldare con o'ring



TUBO PIPE	SERIE SERIES	Referencia Part n°	€	Referencia STA Part N° STA
6	L	Z ASL 6	13,02	Z STA ASL 6
8	L	Z ASL 8	13,07	Z STA ASL 8
10	L	Z ASL 10	15,72	Z STA ASL 10
12	L	Z ASL 12	17,19	Z STA ASL 12
15	L	Z ASL 15	23,42	Z STA ASL 15
18	L	Z ASL 18	27,86	Z STA ASL 18
22	L	Z ASL 22	36,75	Z STA ASL 22
28	L	Z ASL 28	51,63	Z STA ASL 28
35	L	Z ASL 35	81,68	Z STA ASL 35
42	L	Z ASL 42	119,11	Z STA ASL 42
6	S	Z ASS 6	22,21	Z STA ASS 6
8	S	Z ASS 8	25,31	Z STA ASS 8
10	S	Z ASS 10	29,63	Z STA ASS 10
12	S	Z ASS 12	30,60	Z STA ASS 12
14	S	Z ASS 14	45,21	Z STA ASS 14
16	S	Z ASS 16	33,94	Z STA ASS 16
20	S	Z ASS 20	41,60	Z STA ASS 20
25	S	Z ASS 25	68,90	Z STA ASS 25
30	S	Z ASS 30	94,87	Z STA ASS 30
38	S	Z ASS 38	195,57	Z STA ASS 38

TUBO PIPE	SERIE SERIES	Referencia Part n°
15x2,5	L	Z ORIL 15
18x2,5	L	Z ORIL 18
22x2,5	L	Z ORIL 22
28x3	L	Z ORIL 28
35x4	L	Z ORIL 35
42x3	L	Z ORIL 42
6x2	L/S	Z ORIS 6
8x2	L/S	Z ORIS 8
10x2	L/S	Z ORIS 10
12x2	L/S	Z ORIS 12
14x3	S	Z ORIS 14
16x3	S	Z ORIS 16
20x3	S	Z ORIS 20
25x3,5	S	Z ORIS 25
30x5	S	Z ORIS 30
38x5	S	Z ORIS 38

Racor pasatabique para soldar

Weldable bulkhead coupling

Raccord union double passe cloison
Métrique à souder

Raccordo passaparete a saldare



TUBO PIPE	SERIE SERIES	Referencia Part n°	€	Referencia STA Part N° STA
6	L	Z ESVL 6	24,57	Z STA ESVL 6
8	L	Z ESVL 8	28,30	Z STA ESVL 8
10	L	Z ESVL 10	29,12	Z STA ESVL 10
12	L	Z ESVL 12	34,63	Z STA ESVL 12
15	L	Z ESVL 15	46,65	Z STA ESVL 15
18	L	Z ESVL 18	60,02	Z STA ESVL 18
22	L	Z ESVL 22	76,68	Z STA ESVL 22
28	L	Z ESVL 28	85,56	Z STA ESVL 28
35	L	Z ESVL 35	123,79	Z STA ESVL 35
42	L	Z ESVL 42	195,72	Z STA ESVL 42
6	S	Z ESVS 6	39,78	Z STA ESVS 6
8	S	Z ESVS 8	42,95	Z STA ESVS 8
10	S	Z ESVS 10	48,62	Z STA ESVS 10
12	S	Z ESVS 12	48,47	Z STA ESVS 12
14	S	Z ESVS 14	81,02	Z STA ESVS 14
16	S	Z ESVS 16	64,58	Z STA ESVS 16
20	S	Z ESVS 20	93,81	Z STA ESVS 20
25	S	Z ESVS 25	138,42	Z STA ESVS 25
30	S	Z ESVS 30	155,95	Z STA ESVS 30
38	S	Z ESVS 38	315,56	Z STA ESVS 38

Racores DIN 2353

DIN 2353 Pipe fittings
Raccords à bague DIN 2353
Raccordi DIN 2353

Racor recto pasatabique con tuerca

Straight bulkhead coupling

Raccord droit union double passe cloison avec écrou

Raccordo passaparete



TUBO PIPE	SERIE SERIES	Referencia Part n°	€	Referencia STA Part N° STA
6	L	Z SVL 6	22,40	Z STA SVL 6
8	L	Z SVL 8	25,66	Z STA SVL 8
10	L	Z SVL 10	33,47	Z STA SVL 10
12	L	Z SVL 12	37,37	Z STA SVL 12
15	L	Z SVL 15	50,47	Z STA SVL 15
18	L	Z SVL 18	68,59	Z STA SVL 18
22	L	Z SVL 22	91,50	Z STA SVL 22
28	L	Z SVL 28	109,23	Z STA SVL 28
35	L	Z SVL 35	180,60	Z STA SVL 35
42	L	Z SVL 42	243,23	Z STA SVL 42
6	S	Z SVS 6	34,09	Z STA SVS 6
8	S	Z SVS 8	35,54	Z STA SVS 8
10	S	Z SVS 10	42,86	Z STA SVS 10
12	S	Z SVS 12	51,79	Z STA SVS 12
14	S	Z SVS 14	64,95	Z STA SVS 14
16	S	Z SVS 16	65,00	Z STA SVS 16
20	S	Z SVS 20	107,87	Z STA SVS 20
25	S	Z SVS 25	175,92	Z STA SVS 25
30	S	Z SVS 30	199,57	Z STA SVS 30
38	S	Z SVS 38	340,09	Z STA SVS 38

Tuerca pasatabique Métrica

Metric nut bulkhead

Écrou Métrique passe cloison

Dado passaparete Metrico



TUBO PIPE	ROSCA THREAD	Referencia Part n°
6L	M12x1,5	KZTPM12
8L / 6S	M14x1,5	KZTPM14
10L / 8S	M16x1,5	KZTPM16
12L / 10S	M18x1,5	KZTPM18
12S	M20x1,5	KZTPM20
15L / 14S	M22x1,5	KZTPM22
16S	M24x1,5	KZTPM24
18L	M26x1,5	KZTPM26
22L / 20S	M30x2	KZTPM30
28L / 25S	M36x2	KZTPM36
30S	M42x2	KZTPM42
35L	M45x2	KZTPM45
42L / 38S	M52x2	KZTPM52

Racor en codo pasatabique con tuerca

Elbow bulkhead coupling

Raccord coude égal passe cloison

Raccordo passaparete a 90°



TUBO PIPE	SERIE SERIES	Referencia Part n°	€	Referencia STA Part N° STA
6	L	Z USVL 6	48,84	Z STA USVL 6
8	L	Z USVL 8	46,64	Z STA USVL 8
10	L	Z USVL 10	44,07	Z STA USVL 10
12	L	Z USVL 12	47,76	Z STA USVL 12
15	L	Z USVL 15	80,42	Z STA USVL 15
18	L	Z USVL 18	84,69	Z STA USVL 18
22	L	Z USVL 22	129,77	Z STA USVL 22
28	L	Z USVL 28	354,96	Z STA USVL 28
35	L	Z USVL 35	617,40	Z STA USVL 35
42	L	Z USVL 42	827,29	Z STA USVL 42
6	S	Z USVS 6	81,28	Z STA USVS 6
8	S	Z USVS 8	63,62	Z STA USVS 8
10	S	Z USVS 10	57,19	Z STA USVS 10
12	S	Z USVS 12	63,48	Z STA USVS 12
14	S	Z USVS 14	97,93	Z STA USVS 14
16	S	Z USVS 16	89,50	Z STA USVS 16
20	S	Z USVS 20	212,85	Z STA USVS 20
25	S	Z USVS 25	401,96	Z STA USVS 25
30	S	Z USVS 30	625,06	Z STA USVS 30

Racores DIN 2353

DIN 2353 Pipe fittings
Raccords à bague DIN 2353
Raccordi DIN 2353

Racor recto hembra rosca BSP

Female stud coupling

Raccord union simple femelle gaz

Raccordo di estremità femmina BSP



TUBO PIPE	SERIE SERIES	ROSCA THREAD	Referencia Part n°	€	Referencia STA Part N° STA
6	L	1/8" BSP	Z GAIL 6 R 1/8	15,27	Z STA GAIL 6 R 1/8
6	L	1/4" BSP	Z GAIL 6 R 1/4	16,45	Z STA GAIL 6 R 1/4
8	L	1/4" BSP	Z GAIL 8 R 1/4	17,93	Z STA GAIL 8 R 1/4
10	L	1/4" BSP	Z GAIL 10 R 1/4	18,40	Z STA GAIL 10 R 1/4
12	L	1/2" BSP	Z GAIL 12 R 1/2	26,48	Z STA GAIL 12 R 1/2
12	L	3/8" BSP	Z GAIL 12 R 3/8	25,73	Z STA GAIL 12 R 3/8
15	L	1/2" BSP	Z GAIL 15 R 1/2	28,82	Z STA GAIL 15 R 1/2
18	L	1/2" BSP	Z GAIL 18 R 1/2	32,71	Z STA GAIL 18 R 1/2
22	L	3/4" BSP	Z GAIL 22 R 3/4	43,66	Z STA GAIL 22 R 3/4
28	L	1" BSP	Z GAIL 28 R 1	70,46	Z STA GAIL 28 R 1
35	L	1 1/4" BSP	Z GAIL 35 R 1 1/4	132,82	Z STA GAIL 35 R 1 1/4
42	L	1 1/2" BSP	Z GAIL 42 R 1 1/2	176,35	Z STA GAIL 42 R 1 1/2
6	S	1/4" BSP	Z GAIS 6 R 1/4	19,66	Z STA GAIS 6 R 1/4
8	S	1/4" BSP	Z GAIS 8 R 1/4	20,59	Z STA GAIS 8 R 1/4
10	S	3/8" BSP	Z GAIS 10 R 3/8	23,90	Z STA GAIS 10 R 3/8
12	S	3/8" BSP	Z GAIS 12 R 3/8	29,94	Z STA GAIS 12 R 3/8
14	S	3/8" BSP	Z GAIS 14 R 3/8	39,93	Z STA GAIS 14 R 3/8
14	S	1/2" BSP	Z GAIS 14 R 1/2	37,84	Z STA GAIS 14 R 1/2
16	S	1/2" BSP	Z GAIS 16 R 1/2	31,41	Z STA GAIS 16 R 1/2
20	S	3/4" BSP	Z GAIS 20 R 3/4	60,04	Z STA GAIS 20 R 3/4
25	S	1" BSP	Z GAIS 25 R 1	73,79	Z STA GAIS 25 R 1
30	S	1 1/4" BSP	Z GAIS 30 R 1 1/4	133,23	Z STA GAIS 30 R 1 1/4
38	S	1 1/2" BSP	Z GAIS 38 R 1 1/2	170,93	Z STA GAIS 38 R 1 1/2

Racor recto hembra rosca Métrica

Female stud coupling Metric Cylindrical

Raccord union simple femelle Métrique

Raccordo di estremità femmina metrica



TUBO PIPE	SERIE SERIES	ROSCA THREAD	Referencia Part n°
6	L	M10X1	Z GAIL 6 M 10X1
8	L	M12X1,5	Z GAIL 8 M 12X1,5
10	L	M14X1,5	Z GAIL 10 M 14X1,5
12	L	M16X1,5	Z GAIL 12 M 16X1,5
15	L	M18X1,5	Z GAIL 15 M 18X1,5
18	L	M22X1,5	Z GAIL 18 M 22X1,5
22	L	M26X1,5	Z GAIL 22 M 26X1,5
28	L	M33X2	Z GAIL 28 M 33X2
35	L	M42X2	Z GAIL 35 M 42X2
42	L	M48X2	Z GAIL 42 M 48X2
6	S	M12X1,5	Z GAIS 6 M 12X1,5
8	S	M14X1,5	Z GAIS 8 M 14X1,5
10	S	M16X1,5	Z GAIS 10 M 16X1,5
12	S	M18X1,5	Z GAIS 12 M 18X1,5
14	S	M20X1,5	Z GAIS 14 M 20X1,5
16	S	M22X1,5	Z GAIS 16 M 22X1,5
20	S	M27X2	Z GAIS 20 M 27X2
25	S	M33X2	Z GAIS 25 M 33X2
30	S	M42X2	Z GAIS 30 M 42X2
38	S	M48X2	Z GAIS 38 M 48X2

Racor para manómetro DKOL/DKOS

Gauge coupling DKOL/DKOS cylindrical

Raccord union pour manomètre DKOL/DKOS

Raccordo per manometro DKOL/DKOS



TUBO PIPE	SERIE SERIES	ROSCA THREAD	Referencia Part n°
6	L	1/4" BSP	Z MAFL 6 R 1/4
8	L	1/4" BSP	Z MAFL 8 R 1/4
10	L	1/4" BSP	Z MAFL 10 R 1/4
12	L	1/4" BSP	Z MAFL 12 R 1/4
6	S	1/2" BSP	Z MAFS 6 R 1/2
8	S	1/2" BSP	Z MAFS 8 R 1/2
10	S	1/2" BSP	Z MAFS 10 R 1/2
12	S	1/2" BSP	Z MAFS 12 R 1/2

Racor para manómetro BSP

Gauge coupling BSP cylindrical

Raccord union pour manomètre gaz

Raccordo per manometro BSP



TUBO PIPE	SERIE SERIES	ROSCA THREAD	Referencia Part n°
6	L	1/4" BSP	Z MAVL 6 R 1/4
8	L	1/4" BSP	Z MAVL 8 R 1/4
10	L	1/4" BSP	Z MAVL 10 R 1/4
12	L	1/4" BSP	Z MAVL 12 R 1/4
6	S	1/2" BSP	Z MAVS 6 R 1/2
8	S	1/2" BSP	Z MAVS 8 R 1/2
10	S	1/2" BSP	Z MAVS 10 R 1/2
12	S	1/2" BSP	Z MAVS 12 R 1/2

Arandela para manómetros

Seal for gauge coupling

Raccord bague pour manomètres

Guarnizione per manometro



ROSCA THREAD	Referencia Part n°
1/4" BSP	Z AM 6
1/2" BSP	Z AM 12

Racores DIN 2353

DIN 2353 Pipe fittings
Raccords à bague DIN 2353
Raccordi DIN 2353

Racor en codo orientable sin estrangulación rosca BSP

Banjo coupling with captive seal and o'ring BSP cylindrical
Raccord équerre orientable articulée sans étranglement gaz
Raccordo orientabile 90° ad occhio BSP con guarnizione



TUBO PIPE	SERIE SERIES	ROSCA THREAD	Referencia Part n°	€	Referencia STA Part N° STA
6	L	1/8" BSP	Z WSVL 6 R 1/8	73,77	Z STA WSVL 6 R 1/8
6	L	1/4" BSP	Z WSVL 6 R 1/4	87,92	Z STA WSVL 6 R 1/4
8	L	1/4" BSP	Z WSVL 8 R 1/4	78,57	Z STA WSVL 8 R 1/4
10	L	1/4" BSP	Z WSVL 10 R 1/4	81,96	Z STA WSVL 10 R 1/4
12	L	3/8" BSP	Z WSVL 12 R 3/8	91,15	Z STA WSVL 12 R 3/8
15	L	1/2" BSP	Z WSVL 15 R 1/2	151,62	Z STA WSVL 15 R 1/2
18	L	1/2" BSP	Z WSVL 18 R 1/2	197,99	Z STA WSVL 18 R 1/2
22	L	3/4" BSP	Z WSVL 22 R 3/4	317,04	Z STA WSVL 22 R 3/4
28	L	1" BSP	Z WSVL 28 R 1	522,39	Z STA WSVL 28 R 1
35	L	1 1/4" BSP	Z WSVL 35 R 1 1/4	678,20	Z STA WSVL 35 R 1 1/4
42	L	1 1/2" BSP	Z WSVL 42 R 1 1/2	950,92	Z STA WSVL 42 R 1 1/2
6	S	1/4" BSP	Z WSVS 6 R 1/4	85,67	Z STA WSVS 6 R 1/4
8	S	1/4" BSP	Z WSVS 8 R 1/4	85,93	Z STA WSVS 8 R 1/4
10	S	3/8" BSP	Z WSVS 10 R 3/8	112,22	Z STA WSVS 10 R 3/8
12	S	3/8" BSP	Z WSVS 12 R 3/8	124,91	Z STA WSVS 12 R 3/8
14	S	1/2" BSP	Z WSVS 14 R 1/2	170,35	Z STA WSVS 14 R 1/2
16	S	1/2" BSP	Z WSVS 16 R 1/2	207,02	Z STA WSVS 16 R 1/2
20	S	3/4" BSP	Z WSVS 20 R 3/4	320,41	Z STA WSVS 20 R 3/4
25	S	1" BSP	Z WSVS 25 R 1	464,58	Z STA WSVS 25 R 1
30	S	1 1/4" BSP	Z WSVS 30 R 1 1/4	1.067,10	Z STA WSVS 30 R 1 1/4
38	S	1 1/2" BSP	Z WSVS 38 R 1 1/2	1.151,38	Z STA WSVS 38 R 1 1/2

Racor en codo orientable sin estrangulación rosca Métrica

Banjo coupling with captive seal and o'ring Metric cylindrical
Raccord équerre orientable articulée sans étranglement Métrique
Raccordo orientabile 90° ad occhio Metrico con guarnizione



TUBO PIPE	SERIE SERIES	ROSCA THREAD	Referencia Part n°	€	Referencia STA Part N° STA
6	L	M10X1	Z WSVL 6 M 10X1	74,85	Z STA WSVL 6 M 10X1
8	L	M12X1,5	Z WSVL 8 M 12X1,5	78,23	Z STA WSVL 8 M 12X1,5
10	L	M14X1,5	Z WSVL 10 M 14X1,5	109,87	Z STA WSVL 10 M 14X1,5
12	L	M16X1,5	Z WSVL 12 M 16X1,5	125,02	Z STA WSVL 12 M 16X1,5
15	L	M18X1,5	Z WSVL 15 M 18X1,5	167,79	Z STA WSVL 15 M 18X1,5
18	L	M22X1,5	Z WSVL 18 M 22X1,5	213,32	Z STA WSVL 18 M 22X1,5
22	L	M26X1,5	Z WSVL 22 M 26X1,5	*	Z STA WSVL 22 M 26X1,5
28	L	M33X2	Z WSVL 28 M 33X2	*	Z STA WSVL 28 M 33X2
35	L	M42X2	Z WSVL 35 M 42X2	*	Z STA WSVL 35 M 42X2
42	L	M48X2	Z WSVL 42 M 48X2	*	Z STA WSVL 42 M 48X2
6	S	M12X1,5	Z WSVS 6 M 12X1,5	104,67	Z STA WSVS 6 M 12X1,5
8	S	M14X1,5	Z WSVS 8 M 14X1,5	111,65	Z STA WSVS 8 M 14X1,5
10	S	M16X1,5	Z WSVS 10 M 16X1,5	130,30	Z STA WSVS 10 M 16X1,5
12	S	M18X1,5	Z WSVS 12 M 18X1,5	147,25	Z STA WSVS 12 M 18X1,5
14	S	M20X1,5	Z WSVS 14 M 20X1,5	141,73	Z STA WSVS 14 M 20X1,5
16	S	M22X1,5	Z WSVS 16 M 22X1,5	255,46	Z STA WSVS 16 M 22X1,5
20	S	M27X2	Z WSVS 20 M 27X2	329,96	Z STA WSVS 20 M 27X2
30	S	M42X2	Z WSVS 30 M 42X2	669,80	Z STA WSVS 30 M 42X2
38	S	M48x2	Z WSVS 38 M 48X2	*	Z STA WSVS 38 M 48X2

Racores DIN 2353

DIN 2353 Pipe fittings
Raccords à bague DIN 2353
Raccordi DIN 2353

Tapón de cierre para tubo con junta tórica

Blanking plug with o'ring

Raccord bouchon de fermeture avec o'ring

Tappo di chiusura con o'ring



TUBO PIPE	SERIE SERIES	Referencia Part n°
6	L/S	Z BUTZEN L 6
8	L/S	Z BUTZEN L 8
10	L/S	Z BUTZEN L 10
12	L/S	Z BUTZEN L 12
15	L	Z BUTZEN L 15
18	L	Z BUTZEN L 18
22	L	Z BUTZEN L 22
28	L	Z BUTZEN L 28
35	L	Z BUTZEN L 35
42	L	Z BUTZEN L 42
14	S	Z BUTZEN S 14
16	S	Z BUTZEN S 16
20	S	Z BUTZEN S 20
25	S	Z BUTZEN S 25
30	S	Z BUTZEN S 30
38	S	Z BUTZEN S 38

Tapón de cierre Allen rosca BSP con junta

Blanking plug with captive seal BSP cylindrical

Raccord bouchon Allen gaz avec joint plat

Tappo cilindrico BSP esagono incassato con guarnizione

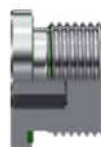

ROSCA THREAD	Referencia Part n°
1/8" BSP	Z STOPFEN 1/8
1/4" BSP	Z STOPFEN 1/4
3/8" BSP	Z STOPFEN 3/8
1/2" BSP	Z STOPFEN 1/2
3/4" BSP	Z STOPFEN 3/4
1" BSP	Z STOPFEN 1
1"1/4 BSP	Z STOPFEN 1 1/4
1"1/2 BSP	Z STOPFEN 1 1/2

Tapón de cierre Allen rosca Métrica con junta

Blanking plug with captive seal Metric cylindrical

Raccord bouchon Allen Métrique avec joint plat

Tappo cilindrico Metrico esagono incassato con guarnizione

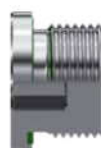

ROSCA THREAD	Referencia Part n°
M10X1	Z STOPFEN M 10X1
M12X1,5	Z STOPFEN M 12X1,5
M14X1,5	Z STOPFEN M 14X1,5
M16X1,5	Z STOPFEN M 16X1,5
M18X1,5	Z STOPFEN M 18X1,5
M20X1,5	Z STOPFEN M 20X1,5
M22X1,5	Z STOPFEN M 22X1,5
M26X1,5	Z STOPFEN M 26X1,5
M27X2	Z STOPFEN M 27X2
M33X2	Z STOPFEN M 33X2
M42X2	Z STOPFEN M 42X2
M48X2	Z STOPFEN M 48X2

Juntas tóricas FKM verde

Green FKM o-ring

Joint torique en FKM vert

O'ring FKM verde



TUBO PIPE	Referencia Part n°
6	JVT06
8	JVT08
10	JVT10
12	JVT12
14	JVT14
15-16	JVT15
18	JVT18
20	JVT20
22	JVT22
25	JVT25
28	JVT28
30	JVT30
35	JVT35
38	JVT38
42	JVT42

Juntas planas FKM verde

Green FKM captive seal

Joint plat en FKM vert

Guarnizione piana FKM verde



ROSCA THREAD	Referencia Part n°
1/8" BSP - M10x1	JVBSP02
M12x1,5	JVM12
1/4" BSP - M14x1,5	JVBSP04
M16x1,5	JVM16
3/8" BSP	JVBSP06
M18x1,5	JVM18
M20x1,5	JVM20
1/2" BSP	JVBSP08
M22x1,5	JVM22
3/4" BSP - M26x1,5	JVBSP12
1" BSP - M33x2	JVBSP16
1"1/4 BSP - M42x2	JVBSP20
1"1/2 BSP - M48x2	JVBSP24
2" BSP	JVBSP32

Racores DIN 2353

DIN 2353 Pipe fittings
Raccords à bague DIN 2353
Raccordi DIN 2353

Vomo

Tool for manual pre-assembly

Outil pour pre-montage

Utensili di premontaggio



TUBO PIPE	SERIE SERIES	ROSCA THREAD	Referencia Part n°	€
6	L	12x1.5	Z VOMO L 6	*
8	L	14x1.5	Z VOMO L 8	*
10	L	16x1.5	Z VOMO L 10	*
12	L	18x1.5	Z VOMO L 12	*
15	L	22x1.5	Z VOMO L 15	*
18	L	26x1.5	Z VOMO L 18	*
22	L	30x2.0	Z VOMO L 22	*
28	L	36x2.0	Z VOMO L 28	*
35	L	45x2.0	Z VOMO L 35	*
42	L	52x2.0	Z VOMO L 42	*
6	S	14x1.5	Z VOMO S 6	*
8	S	16x1.5	Z VOMO S 8	*
10	S	18x1.5	Z VOMO S 10	*
12	S	20x1.5	Z VOMO S 12	*
14	S	22x1.5	Z VOMO S 14	*
16	S	24x1.5	Z VOMO S 16	*
20	S	30x2.0	Z VOMO S 20	*
25	S	36x2.0	Z VOMO S 25	*
30	S	42x2.0	Z VOMO S 30	*

Material Acero Templado / Made of Hardened tool-steel / Matériel Acier Trempé / Materiale acciaio temprato

Grasa

Grease

Graisse

Lubrificante



PESO (gr) WEIGHT (gr)	Referencia Part n°
145	GR ASW120

Racores DIN 2353

DIN 2353 Pipe fittings
Raccords à bague DIN 2353
Raccordi DIN 2353

Válvula antirretorno rosca BSP-tubo

Non-return valve flow from male stud end BSP cylindrical

Clapet anti-rétour unidirectionnel à gauche mâle-tube

Valvola di ritegno a sinistra con guarnizione piana



Válvula antirretorno tubo-tubo

Non-return valve tube-tube

Clapet anti-rétour bidirectionnel tube-tube

Valvola di ritegno tubo-tubo

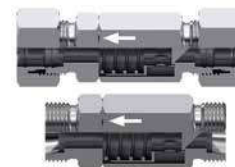

TUBO PIPE	SERIE SERIES	ROSCA THREAD	Referencia Part n°	€
6	L	1/8" BSP	Z RHVL 6 R 1/8	*
8	L	1/4" BSP	Z RHVL 8 R 1/4	*
10	L	1/4" BSP	Z RHVL 10 R 1/4	*
12	L	3/8" BSP	Z RHVL 12 R 3/8	*
15	L	1/2" BSP	Z RHVL 15 R 1/2	*
18	L	1/2" BSP	Z RHVL 18 R 1/2	*
22	L	3/4" BSP	Z RHVL 22 R 3/4	*
28	L	1" BSP	Z RHVL 28 R 1	*
35	L	1"1/4 BSP	Z RHVL 35 R 1 1/4	*
42	L	1"1/2 BSP	Z RHVL 42 R 1 1/2	*
6	S	1/4" BSP	Z RHVS 6 R 1/4	*
8	S	1/4" BSP	Z RHVS 8 R 1/4	*
10	S	3/8" BSP	Z RHVS 10 R 3/8	*
12	S	3/8" BSP	Z RHVS 12 R 3/8	*
14	S	1/2" BSP	Z RHVS 14 R 1/2	*
16	S	1/2" BSP	Z RHVS 16 R 1/2	*
20	S	3/4" BSP	Z RHVS 20 R 3/4	*
25	S	1" BSP	Z RHVS 25 R 1	*
30	S	1"1/4 BSP	Z RHVS 30 R 1 1/4	*
38	S	1"1/2 BSP	Z RHVS 38 R 1 1/2	*

Taraje 1 bar. Para otras presiones de tarado estandar, consultar. / Setting 1 bar. For other standard spring pressures, consult us. / Tarage 1 bar. Pour d'autres pressions ressort standard, consultez-nous. / Per altre pressioni di taratura standard, consultare.

TUBO PIPE	SERIE SERIES	Referencia Part n°	€	Referencia STA Part N° STA
6	L	Z RHDL 6	40,22	Z STA RHDL 6
8	L	Z RHDL 8	49,73	Z STA RHDL 8
10	L	Z RHDL 10	48,16	Z STA RHDL 10
12	L	Z RHDL 12	58,01	Z STA RHDL 12
15	L	Z RHDL 15	68,36	Z STA RHDL 15
18	L	Z RHDL 18	94,43	Z STA RHDL 18
22	L	Z RHDL 22	127,45	Z STA RHDL 22
28	L	Z RHDL 28	212,20	Z STA RHDL 28
35	L	Z RHDL 35	760,41	Z STA RHDL 35
42	L	Z RHDL 42	1.176,73	Z STA RHDL 42
6	S	Z RHDS 6	40,55	Z STA RHDS 6
8	S	Z RHDS 8	42,09	Z STA RHDS 8
10	S	Z RHDS 10	50,15	Z STA RHDS 10
12	S	Z RHDS 12	59,02	Z STA RHDS 12
14	S	Z RHDS 14	72,26	Z STA RHDS 14
16	S	Z RHDS 16	85,62	Z STA RHDS 16
20	S	Z RHDS 20	112,03	Z STA RHDS 20
25	S	Z RHDS 25	194,34	Z STA RHDS 25
30	S	Z RHDS 30	326,02	Z STA RHDS 30
38	S	Z RHDS 38	715,02	Z STA RHDS 38

Taraje 1 bar. Para otras presiones de tarado estandar, consultar. / Setting 1 bar. For other standard spring pressures, consult us. / Tarage 1 bar. Pour d'autres pressions ressort standard, consultez-nous. / Per altre pressioni di taratura standard, consultare.

Válvula antirretorno tubo-rosca BSP

Non-return valve flow towards male stud end BSP cylindrical

Clapet anti-rétour unidirectionnel à droite tube-mâle

Valvola di ritegno a destra con guarnizione piana



TUBO PIPE	SERIE SERIES	ROSCA THREAD	Referencia Part n°	€
6	L	1/8" BSP	Z RHZL 6 R 1/8	*
8	L	1/4" BSP	Z RHZL 8 R 1/4	*
10	L	1/4" BSP	Z RHZL 10 R 1/4	*
12	L	3/8" BSP	Z RHZL 12 R 3/8	*
15	L	1/2" BSP	Z RHZL 15 R 1/2	*
18	L	1/2" BSP	Z RHZL 18 R 1/2	*
22	L	3/4" BSP	Z RHZL 22 R 3/4	*
28	L	1" BSP	Z RHZL 28 R 1	*
35	L	1"1/4 BSP	Z RHZL 35 R 1 1/4	*
42	L	1"1/2 BSP	Z RHZL 42 R 1 1/2	*
6	S	1/4" BSP	Z RHZS 6 R 1/4	*
8	S	1/4" BSP	Z RHZS 8 R 1/4	*
10	S	3/8" BSP	Z RHZS 10 R 3/8	*
12	S	3/8" BSP	Z RHZS 12 R 3/8	*
14	S	1/2" BSP	Z RHZS 14 R 1/2	*
16	S	1/2" BSP	Z RHZS 16 R 1/2	*
20	S	3/4" BSP	Z RHZS 20 R 3/4	*
25	S	1" BSP	Z RHZS 25 R 1	*
30	S	1"1/4 BSP	Z RHZS 30 R 1 1/4	*
38	S	1"1/2 BSP	Z RHZS 38 R 1 1/2	*

Taraje 1 bar. Para otras presiones de tarado estandar, consultar. / Setting 1 bar. For other standard spring pressures, consult us. / Tarage 1 bar. Pour d'autres pressions ressort standard, consultez-nous. / Per altre pressioni di taratura standard, consultare.

Incorporamos válvulas antirretorno sin tuerca ni anillo

Non-return valve only body

Racores JIC 37º

Flare fittings JIC 37º

Adapteurs JIC 37º

Raccordi JIC 37º

Tuercas JIC 37º

Nut JIC 37º

Écrou JIC 37º

Dado JIC



TUBO PIPE	ROSCA THREAD	Referencia Part nº	
6	1/4"	7/16" 20h UNF	ZS11006
8	5/16"	1/2" 20h UNF	ZS11008
10	3/8"	9/16" 18h UNF	ZS11010
12	1/2"	3/4" 16h UNF	ZS11012
14-15-16	5/8"	7/8" 14h UNF	ZS11016
18-20	-	1"1/16 12h UN	ZS11020
-	3/4"	1"1/16 12h UNF	ZS11020W
25	1"	1"5/16 12h UN	ZS11025
30-32	1 1/4"	1"5/8 12h UN	ZS11032
38	1 1/2"	1"7/8 12h UN	ZS11038

Ferulas JIC 37º (tubo Métrico)

Metric tube sleeves JIC 37º

Ferrules JIC 37º pour tube Métrique

Bussola JIC 37º per tubo Metrico



TUBO PIPE	Referencia Part nº
6	ZS12006
8	ZS12008
10	ZS12010
12	ZS12012
14	ZS12014
15	ZS12015
16	ZS12016
18	ZS12018
20	ZS12020
25	ZS12025
30	ZS12030
32	ZS12032
38	ZS12038

Ferulas JIC 37º (tubo Gas)

Tube sleeves Gas JIC 37º

Ferrules JIC 37º pour tube Gaz

Bussola JIC 37º per tubo gas



TUBO PIPE	Referencia Part nº
1/4"	ZS12104
5/16"	ZS12105
3/8"	ZS12106
1/2"	ZS12108
5/8"	ZS12110
3/4"	ZS12112
1"	ZS12116
1"1/4	ZS12120
1"1/2	ZS12124

Tapón macho JIC 37º

Plug male JIC 37º

Bouchon mâle JIC 37º

Tappo maschio JIC 37º



TUBO PIPE	ROSCA THREAD	Referencia Part nº	
6	1/4"	7/16" 20h UNF	ZS14006
8	5/16"	1/2" 20h UNF	ZS14008
10	3/8"	9/16" 18h UNF	ZS14010
12	1/2"	3/4" 16h UNF	ZS14012
14-15-16	5/8"	7/8" 14h UNF	ZS14016
18-20	3/4"	1"1/16 12h UN	ZS14020
25	1"	1"5/16 12h UN	ZS14025
30-32	1 1/4"	1"5/8 12h UN	ZS14032
38	1 1/2"	1"7/8 12h UN	ZS14038

Tapón hembra giratoria JIC 37º

Cap JIC 37º

Bouchon femelle JIC 37º

Tappo femmina girevole JIC 37º



TUBO PIPE	ROSCA THREAD	Referencia Part nº	
6	1/4"	7/16"-20h UNF	ZS13006
8	5/16"	1/2"-20h UNF	ZS13008
10	3/8"	9/16"-18h UNF	ZS13010
12	1/2"	3/4"-16h UNF	ZS13012
14-15-16	5/8"	7/8"-14h UNF	ZS13016
18-20	3/4"	1"1/16-12h UN	ZS13020
25	1"	1"5/16-12h UN	ZS13025
30-32	1 1/4"	1"5/8-12h UN	ZS13032
38	1 1/2"	1"7/8-12h UN	ZS13038

CRIMPING FITTINGS
FOR HOSES

PIPE
FITTINGS

PIPE
FITTINGS II

ADAPTORS

WELDING
FITTINGS

INDUSTRIAL
FITTINGS

ACCESSORIES

CONTROL
COMPONENTS

FLOW
MEASURING

TRAILER LOK

Racores JIC 37°

Flare fittings JIC 37°

Adaptateurs JIC 37°

Raccordi JIC 37°

Racor macho-macho JIC 37°

Straight union JIC 37°

Adaptateur droit mâle JIC 37°

Nipples maschio-maschio JIC 37°



TUBO PIPE	ROSCA THREAD	Referencia Part n°	
6	1/4"	7/16" 20h UNF	ZS26006
8	5/16"	1/2" 20h UNF	ZS26008
10	3/8"	9/16" 18h UNF	ZS26010
12	1/2"	3/4" 16h UNF	ZS26012
14-15-16	5/8"	7/8" 14h UNF	ZS26016
18-20	3/4"	1"1/16 12h UN	ZS26020
25	1"	1"5/16 12h UN	ZS26025
30-32	1" 1/4	1"5/8 12h UN	ZS26032
38	1" 1/2	1"7/8 12h UN	ZS26038
50	2"	2" 1/2 12h UN	ZS26050

Racor reducción macho-macho JIC 37°

Reducer adaptor male JIC 37°

Adaptateur réduction mâle JIC 37°

Nipples di riduzione maschio-maschio JIC 37°

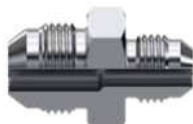

TUBO PIPE	ROSCA THREAD	Referen Part n	
8 5/16"	6 1/4"	1/2" 20h UNF 7/16" 20h UNF	ZS26008
10 5/16"	6 1/4"	9/16" 18h UNF 7/16" 20h UNF	ZS26010
10 3/8"	8 5/16"	9/16" 18h UNF 1/2" 20h UNF	ZS26010
12 1/2"	6 1/4"	3/4" 16h UNF 7/16" 20h UNF	NEW ZS26012
12 1/2"	10 3/8"	3/4" 16h UNF 9/16" 18h UNF	ZS26012
14-15-16 5/8"	12 1/2"	7/8" 14h UNF 3/4" 16h UNF	ZS26016
18-20 3/4"	14-15-16 5/8"	1"1/16 12h UN 7/8" 14h UNF	ZS26020
25 1"	18-20 3/4"	1"5/16 12h UN 1"1/16 12h UN	ZS26025
30-32 1"1/4	25 1"	1"5/8 12h UN 1"5/16 12h UN	ZS26032
38 1"1/2	30-32 1"1/4	1"7/8 12h UN 1"5/8 12h UN	ZS26038

Racor pasatabiques JIC 37°

Straight bulkhead fitting JIC 37°

Union passe cloison droite mâle JIC 37° équipé

Nipples passaparete JIC 37°



TUBO PIPE	ROSCA THREAD	Referencia Part n°	
6	1/4"	7/16" 20h UNF	ZS25006
8	5/16"	1/2" 20h UNF	ZS25008
10	3/8"	9/16" 18h UNF	ZS25010
12	1/2"	3/4" 16h UNF	ZS25012
14-15-16	5/8"	7/8" 14h UNF	ZS25016
18-20	3/4"	1"1/16 12h UN	ZS25020
25	1"	1"5/16 12h UN	ZS25025
30-32	1" 1/4	1"5/8 12h UN	ZS25032
38	1" 1/2	1"7/8 12h UN	ZS25038

Racor macho-macho JIC 37° con junta

Straight union JIC 37° with o'ring

Adaptateur droit mâle JIC 37° avec o'ring

Nipples maschio-maschio JIC 37° con O'ring



TUBO PIPE	ROSCA THREAD	Referencia Part n°	
6	1/4"	7/16" 20h UNF	ZS26006OR
8	5/16"	1/2" 20h UNF	ZS26008OR
10	3/8"	9/16" 18h UNF	ZS26010OR
12	1/2"	3/4" 16h UNF	ZS26012OR
14-15-16	5/8"	7/8" 14h UNF	ZS26016OR
18-20	3/4"	1"1/16 12h UN	ZS26020OR
25	1"	1"5/16 12h UN	ZS26025OR
30-32	1" 1/4	1"5/8 12h UN	ZS26032OR
38	1" 1/2	1"7/8 12h UN	ZS26038OR

Racor macho JIC 37° - macho Métrico

Metric adaptor male - male JIC 37°

Adaptateur mâle JIC 37° - mâle Métrique

Nipples maschio JIC 37° - maschio metrico con O'ring

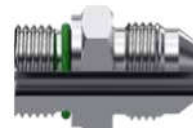

TUBO PIPE	ROSCA THREAD	Referencia Part n°	
6	1/4"	M10x1 7/16" 20h UNF	ZS2400610
8	5/16"	M10x1 1/2" 20h UNF	ZS2400810*
8	5/16"	M12x1.5 1/2" 20h UNF	ZS2400812
8	5/16"	M14x1.5 1/2" 20h UNF	ZS2400814*
10	3/8"	M12x1.5 9/16" 18h UNF	ZS2401012
10	3/8"	M14x1.5 9/16" 18h UNF	ZS2401014
10	3/8"	M16x1.5 9/16" 18h UNF	ZS2401016
12	1/2"	M14x1.5 3/4" 16h UNF	ZS2401214
12	1/2"	M16x1.5 3/4" 16h UNF	ZS2401216
12	1/2"	M18x1.5 3/4" 16h UNF	ZS2401218
14-15-16	5/8"	M18x1.5 7/8" 14h UNF	ZS2401418
14-15-16	5/8"	M27x2 7/8" 14h UNF	ZS2401427*
14-15-16	5/8"	M22x1.5 7/8" 14h UNF	ZS2401622
18-20	3/4"	M22x1.5 1"1/16 12h UN	ZS2402022
18-20	3/4"	M27x2 1"1/16 12h UN	ZS2402027
25	1"	M27x2 1"5/16 12h UNF	ZS2402527*
25	1"	M33x2 1"5/16 12h UN	ZS2402533
30-32	1" 1/4	M42x2 1"5/8 12h UN	ZS2403242
38	1" 1/2	M50x2 1"7/8 12h UN	ZS2403850

* Hasta fin de existencias / Until end of stock / Jusqu'à la fin du stock / Fino ad esaurimento

Racores JIC 37°

Flare fittings JIC 37°

Adapteurs JIC 37°

Raccordi JIC 37°

Racor macho JIC 37° - macho NPT

Straight adaptor male JIC 37° - male NPT pipe

Adapteur mâle JIC 37° - mâle NPT (BRIGGS)

Nipples maschio JIC 37° - maschio conico NPT



TUBO PIPE	ROSCA THREAD	Referencia Part n°
6	1/4" 7/16" 20h UNF 1/8" NPT	ZS2000610
6	1/4" 7/16" 20h UNF 1/4" NPT	ZS2000613
6	1/4" 7/16" 20h UNF 3/8" NPT	ZS2000617
8	5/16" 1/2" 20h UNF 1/8" NPT	ZS2000810
8	5/16" 1/2" 20h UNF 1/4" NPT	ZS2000813
8	5/16" 1/2" 20h UNF 3/8" NPT	ZS2000817
10	3/8" 9/16" 18h UNF 1/8" NPT	ZS2001010
10	3/8" 9/16" 18h UNF 1/4" NPT	ZS2001013
10	3/8" 9/16" 18h UNF 3/8" NPT	ZS2001017
10	3/8" 9/16" 18h UNF 1/2" NPT	ZS2001021
12	1/2" 3/4" 16h UNF 1/4" NPT	ZS2001213
12	1/2" 3/4" 16h UNF 3/8" NPT	ZS2001217
12	1/2" 3/4" 16h UNF 1/2" NPT	ZS2001221
12	1/2" 3/4" 16h UNF 3/4" NPT	ZS2001226
14-15-16	5/8" 7/8" 14h UNF 1/2" NPT	ZS2001621
14-15-16	5/8" 7/8" 14h UNF 3/4" NPT	ZS2001626
18-20	3/4" 1" 1/16 12h UN 1/4" NPT	ZS2002013
18-20	3/4" 1" 1/16 12h UN 1/2" NPT	ZS2002021
18-20	3/4" 1" 1/16 12h UN 3/4" NPT	ZS2002026
18-20	3/4" 1" 1/16 12h UN 1" NPT	ZS2002033
25	1" 1" 5/16 12h UN 3/4" NPT	ZS2002526
25	1" 1" 5/16 12h UN 1" NPT	ZS2002533
30-32	1" 1" 5/16 12h UN 1" 1/4 NPT	ZS2002542
30-32	1" 1/4 1" 5/8 12h UN 1" NPT	ZS2003233
30-32	1" 1/4 1" 5/8 12h UN 1 1/4" NPT	ZS2003242
38	1" 1/2 1" 7/8 12h UN 1" NPT	ZS2003833
38	1" 1/2 1" 7/8 12h UN 1 1/4" NPT	ZS2003842
38	1" 1/2 1" 7/8 12h UN 1 1/2" NPT	ZS2003848
50	2" 2" 1/2 12h UN 2" NPT	ZS2005060

Hembra giratoria JIC 37° - macho UNF

Straight adaptor swivel female JIC 37° - male UNF

Adapteur femelle tournante JIC 37° - mâle UNF

Nipples femmina girevole JIC 37° - maschio UNF



TUBO PIPE	ROSCA (H) THREAD (F)	ROSCA (M) THREAD (M)	Referencia Part n°	€
6	1/4" 7/16" 20h UNF	7/16" 20h UNF	ZS38006	*
10	3/8" 9/16" 18h UNF	9/16" 18h UNF	ZS38010	*
12	1/2" 3/4" 16h UNF	3/4" 16h UNF	ZS38012	*
14-15-16	5/8" 7/8" 14h UNF	7/8" 14h UNF	ZS38016	*
18-20	3/4" 1" 1/16 12h UN	1" 1/16 12h UN	ZS38020	*
25	1" 1" 5/16 12h UN	1" 5/16 12h UN	ZS38025	*

*Ver precios en p.185 (ADAPTADORES O'RING BOSS) / *See prices in p.185 (O'RING BOSS ADAPTORS) / *Prix à la p.185 (ADAPTEURS O'RING BOSS) / *Vedere prezzi p.185 (ADATTATORI O'RING BOSS)

Racor macho JIC 37° - macho BSP

Straight adaptor male JIC 37° - male BSP

Adapteur mâle JIC 37° - mâle BSP équipé

Nipples maschio JIC 37° - maschio BSP con rondella e O'ring



TUBO PIPE	ROSCA THREAD	TUBO PIPE	ROSCA THREAD	Referencia Part n°
6	1/8" BSP 1/4" 7/16" 20h UNF			ZS2300610
6	1/4" BSP 1/4" 7/16" 20h UNF			ZS2300613
6	3/8" BSP 1/4" 7/16" 20h UNF			ZS2300617
6	1/2" BSP 1/4" 7/16" 20h UNF			ZS2300621
8	1/4" BSP 5/16" 1/2" 20h UNF			ZS2300813
8	3/8" BSP 5/16" 1/2" 20h UNF			ZS2300817
10	1/4" BSP 3/8" 9/16" 18h UNF			ZS2301013
10	3/8" BSP 3/8" 9/16" 18h UNF			ZS2301017
10	1/2" BSP 3/8" 9/16" 18h UNF			ZS2301021
12	1/4" BSP 1/2" 3/4" 16h UNF			ZS2301213
12	3/8" BSP 1/2" 3/4" 16h UNF			ZS2301217
12	1/2" BSP 1/2" 3/4" 16h UNF			ZS2301221
12	3/4" BSP 1/2" 3/4" 16h UNF			ZS2301226
14-15-16	3/8" BSP 5/8" 7/8" 14h UNF			ZS2301617
14-15-16	1/2" BSP 5/8" 7/8" 14h UNF			ZS2301621
14-15-16	3/4" BSP 5/8" 7/8" 14h UNF			ZS2301626
18-20	1/2" BSP 3/4" 1" 1/16 12h UN			ZS2302021
18-20	3/4" BSP 3/4" 1" 1/16 12h UN			ZS2302026
18-20	1" BSP 3/4" 1" 1/16 12h UN			ZS2302033
25	1/2" BSP 1" 1" 5/16 12h UN			ZS2302521*
25	3/4" BSP 1" 1" 5/16 12h UN			ZS2302526
25	1" BSP 1" 1" 5/16 12h UN			ZS2302533
25	1" 1/4 BSP 1" 1" 5/16 12h UN			ZS2302542
30-32	1" BSP 1" 1" 5/8 12h UN			ZS2303233
30-32	1" 1/4 BSP 1 1/4" 1" 5/8 12h UN			ZS2303242
38	1" 1/4 BSP 1 1/2" 1" 7/8 12h UN			ZS2303842
38	1" 1/2 BSP 1 1/2" 1" 7/8 12h UN			ZS2303848
38	2" BSP 1 1/2" 1" 7/8 12h UN			ZS2303860
40	1/2" BSP 2" 2" 1/2 12h UN			ZS2305021 <small>NEW</small>

*Hasta fin de existencias / Until end of stock / Jusqu'à la fin du stock / Fino ad esaurimento

Racor macho BSP - hembra giratoria JIC 37°

Straight adaptor male BSP - swivel female JIC 37°

Adapteur mâle BSP - femelle tournante JIC 37°

Adattatore maschio BSP con rondella e O'ring - femmina girevole JIC 37°



TUBO PIPE	ROSCA THREAD	Referencia Part n°
6	1/4" 1/8" BSP 7/16" 20h UNF	ZS1800610
8	5/16" 1/4" BSP 1/2" 20h UNF	ZS1800813
10	3/8" 1/4" BSP 9/16" 18h UNF	ZS1801013
10	3/8" 3/8" BSP 9/16" 18h UNF	ZS1801017
10	3/8" 1/2" BSP 9/16" 18h UNF	ZS1801021
12	1/2" 3/8" BSP 3/4" 16h UNF	ZS1801217
14-15-16	5/8" 1/2" BSP H 3/4" 16h UNF	ZS1801221
14-15-16	5/8" 1/2" BSP 7/8" 14h UNF	ZS1801621
18-20	3/4" 3/4" BSP 1" 1/16 12h UNF	ZS1802026
25	1" 1" BSP 1" 5/16 12h UNF	ZS1802533
30-32	1" 1/4 1" 1/4 BSP 1" 5/8 12h UNF	ZS1803242
38	1" 1/2 1" 1/2 BSP 1" 7/8 12h UNF	ZS1803848

Racores JIC 37º

Flare fittings JIC 37º

Adaptateurs JIC 37º

Raccordi JIC 37º

Racor macho JIC 37º - macho BSPT

Straight adaptor male JIC 37º - male BSPT

Adaptateur mâle JIC 37º - mâle BSPT

Nipples maschio JIC 37º - maschio conico BSPT



Adaptador Macho JIC - hembra giratoria JIC 37º

Adaptor male JIC - swivel female JIC

Adaptateur mâle JIC x femelle tournante JIC

Adattatore maschio JIC 37º - femmina girevole JIC 37º



TUBO PIPE	ROSCA THREAD		Referencia Part nº
6	1/4"	7/16" 20h UNF	1/8" BSPT ZS2100610
6	1/4"	7/16" 20h UNF	1/4" BSPT ZS2100613
8	5/16"	1/2" 20h UNF	1/8" BSPT ZS2100810
8	5/16"	1/2" 20h UNF	1/4" BSPT ZS2100813
8	5/16"	1/2" 20h UNF	3/8" BSPT ZS2100817
10	3/8"	9/16" 18h UNF	1/4" BSPT ZS2101013
10	3/8"	9/16" 18h UNF	3/8" BSPT ZS2101017
10	3/8"	9/16" 18h UNF	1/2" BSPT ZS2101021
12	1/2"	3/4" 16h UNF	1/4" BSPT ZS2101213
12	1/2"	3/4" 16h UNF	3/8" BSPT ZS2101217
12	1/2"	3/4" 16h UNF	1/2" BSPT ZS2101221
12	1/2"	3/4" 12h UNF	3/4" BSPT ZS2101226
14-15-16	5/8"	7/8" 14h UNF	3/8" BSPT ZS2101617
14-15-16	5/8"	7/8" 14h UNF	1/2" BSPT ZS2101621
14-15-16	5/8"	7/8" 14h UNF	3/4" BSPT ZS2101626
18-20	3/4"	1" 1/16 12h UN	1/2" BSPT ZS2102021
18-20	3/4"	1" 1/16 12h UN	3/4" BSPT ZS2102026
18-20	3/4"	1" 1/16 12h UN	1" BSPT ZS2102033
25	1"	1" 5/16 12h UN	3/4" BSPT ZS2102526
25	1"	1" 5/16 12h UN	1" BSPT ZS2102533
30-32	1" 1/4	1" 5/8 12h UN	1" BSPT ZS2103233
30-32	1" 1/4	1" 5/8 12h UN	1 1/4" BSPT ZS2103242
38	1" 1/2	1" 7/8 12h UN	1 1/2" BSPT ZS2103848

TUBO PIPE	ROSCA THREAD		Referencia Part nº
6	1/4"	7/16" 20 UNF	7/16" 20 UNF ZS7400606
8	5/16"	1/2" 20 UNF	1/2" 20 UNF ZS7400808
10	3/8"	9/16" 18 UNF	9/16" 18 UNF ZS7401010
12	1/2"	3/4" 16 UNF	3/4" 16 UNF ZS7401212
14-15-16	5/8"	7/8" 14 UNF	7/8" 14 UNF ZS7401616
18-20	3/4"	1" 1/16 12 UNF	1" 1/16 12 UNF ZS7402020
25	1"	1" 5/16 12 UNF	1" 5/16 12 UNF ZS7402525

Racor macho JIC 37º - hembra fija NPT

Straight adaptor male JIC 37º - fixed female NPT

Adaptateur mâle JIC 37º - femelle fixe NPT

Adattatore maschio JIC 37º - femmina fissa NPT



TUBO PIPE	ROSCA THREAD		Referencia Part nº
6	1/4"	7/16"-20h UNF	1/8" NPT ZS2950610
6	1/4"	7/16"-20h UNF	1/4" NPT ZS2950613
6	3/8"	7/16"-20h UNF	3/8" NPT ZS2950617 <small>NEW</small>
6	1/2"	7/16"-20h UNF	1/2" NPT ZS2950621 <small>NEW</small>
8	5/16"	1/2"-20h UNF	1/4" NPT ZS2950813
8	5/16"	1/2"-20h UNF	3/8" NPT ZS2950817
10	3/8"	9/16"-20h UNF	1/4" NPT ZS2951013
10	3/8"	9/16"-20h UNF	3/8" NPT ZS2951017
10	1/2"	9/16"-20h UNF	1/2" NPT ZS2951021 <small>NEW</small>
12	1/2"	3/4"-20h UNF	1/4" NPT ZS2951213
12	1/2"	3/4"-20h UNF	3/8" NPT ZS2951217
12	1/2"	3/4"-20h UNF	1/2" NPT ZS2951221
14-15-16	5/8"	7/8"-14h UNF	1/2" NPT ZS2951621
18-20	3/4"	1" 1/16-12h UNF	3/4" NPT ZS2952026
18-20	3/4"	1" 1/16-12h UNF	1" NPT ZS2952033
25	1"	1" 5/16-12 UNF	3/4" NPT ZS2952526 <small>NEW</small>
25	1"	1" 5/16-12 UNF	1" NPT ZS2952533
25	1"	1" 5/16-12 UN	1" 1/4 NPT ZS2952542
30-32	1" 1/4	1" 5/8-12h UNF	1" NPT ZS2953233 <small>NEW</small>
30-32	1" 1/4	1" 5/8-12h UNF	1" 1/4 NPT ZS2953242
38	1" 1/2	1" 7/8 12h UN	1" 1/2 NPT ZS2953842 <small>NEW</small>
38	1 1/2	1" 7/8-12h UNF	1" 1/2 NPT ZS2953848 <small>NEW</small>
50	2" 1/2	2" 1/2 12h UNF	2" NPT ZS2955060 <small>NEW</small>

Racores JIC 37º

Flare fittings JIC 37º

Adapteurs JIC 37º

Raccordi JIC 37º

Racor reducción macho JIC 37º - hembra giratoria JIC 37º

Reducer adaptor male JIC 37º - swivel female JIC 37º

Adapteur réduction mâle JIC 37º - femelle tournante JIC 37º

Nipples di riduzione maschio - femmina girevole JIC 37º



ROSCA (H) THREAD (F)	ROSCA (M) THREAD (M)	TUBO (H) PIPE (F)	TUBO (M) PIPE (M)	Referencia Part nº
9/16" 18h UNF	7/16" 20h UNF	10	6	ZS2911006
9/16" 18h UNF	3/4" 16h UNF	10	12	ZS2911012
9/16" 18h UNF	7/8" 14h UNF	10	14-15-16	ZS2911016
3/4" 16h UNF	7/16" 20h UNF	12	6	ZS2911206
3/4" 16h UNF	1/2" 20h UNF	12	8	ZS2911208
3/4" 16h UNF	9/16" 18h UNF	12	10	ZS2911210
3/4" 16h UNF	1"1/16 12h UN	12	18-20	ZS2911220
3/4" 16h UNF	1"5/16 12h UN	12	25	ZS2911225
7/8" 14h UNF	7/16" 20h UNF	14-15-16	6	ZS2911606
7/8" 14h UNF	9/16" 18h UNF	14-15-16	10	ZS2911610
7/8" 14h UNF	1"1/16 12h UN	14-15-16	18-20	ZS2911620
1"1/16 12h UN	7/16" 20h UNF	18-20	6	ZS2912006
1"1/16 12h UN	9/16" 18h UNF	18-20	10	ZS2912010
1"1/16 12h UN	3/4" 16h UNF	18-20	12	ZS2912012
1"5/16 12h UN	1"1/16 12h UN	25	18-20	ZS2912520
1"5/8 12h UN	7/8" 14h UNF	32	16	ZS2913216
1"5/8 12h UN	1"5/16 12h UN	32	20	ZS2913220
1"5/8 12h UN	1"5/16 12h UN	30-32	25	ZS2913225
1"7/8 14h UNF	1"5/8 12h UN	38	32	NEW ZS2913832

Pueden ser suministradas con tuerca libre o prensada / Material could be delivered with loose or nut / Peut être livrée avec écrou libre ou pré-serti / Fornibile con dado libero o pressato

Racor reducción macho JIC 37 - hembra fija JIC 37º

Reducer adaptor male JIC 37º - fixed female JIC 37º

Adapteur réduction mâle JIC 37º - femelle fixe JIC 37º

Nipples di riduzione maschio - femmina fissa JIC 37º



TUBO (H) PIPE (F)	TUBO (M) PIPE (M)	ROSCA (H) THREAD (F)	ROSCA (M) THREAD (M)	Referencia Part nº
6	8	7/16" 20h UNF	1/2" 20h UNF	ZS2900608
6	10	7/16" 20h UNF	9/16" 18h UNF	ZS2900610
6	12	7/16" 20h UNF	3/4" 16h UNF	ZS2900612
6	25	7/16" 20h UNF	1"5/16 12h UN	ZS2900625
8	14-15-16	1/2" 20h UNF	7/8" 14h UNF	ZS2900816
8	18-20	1/2" 20h UNF	1"1/16 12h UN	ZS2900820
8	25	1/2" 20h UNF	1"5/16 12h UN	ZS2900825
10	8	9/16" 18h UNF	1/2" 20h UNF	ZS2901008
10	25	9/16" 18h UNF	1"5/16 12h UN	ZS2901025
12	30-32	3/4" 16h UNF	1"5/8 12h UN	ZS2901232
12	38	3/4" 16h UNF	1"7/8 12h UN	ZS2901238
14-15-16	12	7/8" 14h UNF	3/4" 16h UNF	ZS2901612
14-15-16	25	7/8" 14h UNF	1"5/16 12h UN	ZS2901625
14-15-16	30-32	7/8" 14h UNF	1"5/8 12h UN	ZS2901632
14-15-16	38	7/8" 14h UNF	1"7/8 12h UN	ZS2901638
18-20	30-32	1"1/16 12h UN	1"5/16 12h UN	ZS2902025
18-20	30-32	1"1/16 12h UN	1"5/8 12h UN	ZS2902032
25	30-32	1"5/16 12h UN	1"5/8 12h UN	ZS2902532
25	38	1"5/16 12h UN	1"7/8 12h UN	ZS2902538
38	30-32	1"7/8 12h UN	1"5/8 12h UN	ZS2903832

Racores JIC 37°

Flare fittings JIC 37°

Adaptateurs JIC 37°

Raccordi JIC 37°

Hembra giratoria JIC 37° - macho NPT

Straight adaptor swivel female JIC 37° - male NPT pipe

Adaptateur femelle tournante JIC 37° - mâle NPT

Niples femmina girevole JIC 37° - maschio NPT



ROSCA THREAD		Referencia Part n°
7/16"-20h UNF	1/4" NPT	ZS1850613
9/16"-18h UNF	3/8" NPT	ZS1851017
3/4"-16h UNF	3/8" NPT	ZS1851217
3/4"-16h UNF	1/2" NPT	ZS1851221
7/8"-14h UNF	1/2" NPT	ZS1851621
1"1/16-12h UNF	3/4" NPT	ZS1852026
1"5/16-12h UNF	1" NPT	ZS1852533
1" 7/8-12h UN	1" 1/2 NPT	ZS1853848

Juntas tóricas FKM verde para macho Métrico

FKM green o'ring for Metric thread

Joint torique FKM vert pour filetage métrique

O'ring FKM verde per maschio metrico



ROSCA THREAD	Referencia Part n°
M10x1	JVMET10
M14x1.5	JVMET14
M16x1.5	JVMET16
M18x1.5	JVMET18
M22x1.5	JVMET22
M27x2	JVMET27
M33x2	JVMET33
M42x2	JVMET42
M50x2	JVMET50

Juntas tóricas FKM verde para rosca UNF

FKM green o'ring for UNF thread

Joint torique FKM vert pour filetage UNF

O'ring FKM verde per filetto UNF



ROSCA THREAD	Referencia Part n°
7/16" UNF	JVUNF06
1/2" UNF	JVUNF08
9/16" UNF	JVUNF10
3/4" UNF	JVUNF12
7/8" UNF	JVUNF16
1" 1/16 UNF	JVUNF20
1"5/16 UNF	JVUNF25
1" 5/8 UNF	JVUNF32
1" 7/8 UNF	JVUNF38

Racor hembra giratoria - hembra giratoria JIC 37°

Straight adaptor swivel female JIC 37°

Adaptateur femelle tournante JIC 37°

Niples femmina - femmina girevole JIC



TUBO PIPE		ROSCA THREAD	Referencia Part n°
6	1/4"	7/16" 20h UNF	ZS73006
8	5/16"	1/2" 20h UNF	ZS73008
10	3/8"	9/16" 18h UNF	ZS73010
12	1/2"	3/4" 16h UNF	ZS73012
14-15-16	5/8"	7/8" 14h UNF	ZS73016
18-20	3/4"	1"1/16 12h UN	ZS73020
25	1"	1"5/16 12h UN	ZS73025
32	1"1/4	1"5/8 12h UN	ZS73032
38	1"1/2	1"7/8 12h UN	ZS73038

Juntas tóricas FKM verde para macho BSP

FKM green o'ring for BSP thread

Joint torique FKM vert pour mâle BSP

O'ring FKM verde per maschio BSP



ROSCA THREAD	Referencia Part n°
1/8" BSP	JVMBSP02
1/4" BSP	JVMBSP04
3/8" BSP	JVMBSP06
1/2" BSP	JVMBSP08
3/4" BSP	JVMBSP12
1" BSP	JVMBSP16
1"1/4 BSP	JVMBSP20
1"1/2 BSP	JVMBSP24
2" BSP	JVMBSP32

Juntas para Macho JIC FKM verde

FKM green o'ring for JIC male thread

Joint FKM vert pour mâle JIC

O'ring FKM verde per filetto JIC



ROSCA THREAD	Referencia Part n°
7/16" 20h UNF	JTVJIC07
9/16" 18h UNF	JTVJIC09
3/4" 16h UNF	JTVJIC12
1"1/16 12h UNF	JTVJIC17
1" 5/16 12h UN	JTVJIC21
1"5/8 12h UNF	JTVJIC26

Racores JIC 37º

Flare fittings JIC 37º

Adapteurs JIC 37º

Raccordi JIC 37º

Codo 90º macho - macho JIC 37º

90º Elbow male - male JIC 37º

Coude 90º mâle - mâle JIC 37º

Adattatore a 90º maschio - maschio JIC 37º



TUBO PIPE	ROSCA THREAD	Referencia Part nº
6	1/4" 7/16" 20h UNF	ZS50006
8	5/16" 1/2" 20h UNF	ZS50008
10	3/8" 9/16" 18h UNF	ZS50010
12	1/2" 3/4" 16h UNF	ZS50012
14-15-16	5/8" 7/8" 14h UNF	ZS50016
18-20	3/4" 1" 1/16 12h UN	ZS50020
25	1" 1" 5/8 12h UN	ZS50025
30-32	1" 1/4 1" 5/8 12h UN	ZS50032
38	1" 1/2 1" 7/8 12h UN	ZS50038

Codo 90º macho JIC 37º - hembra giratoria JIC 37º

90º Elbow swivel female JIC 37º - male JIC 37º

Coude 90º mâle JIC 37º - femelle tournante JIC 37º

Adattatore a 90º maschio JIC 37º - femmina girevole JIC 37º



TUBO PIPE	ROSCA THREAD	Referencia Part nº
6	1/4" 7/16" 20h UNF 7/16" 20h UNF	ZS67506
8	5/16" 1/2" 20h UNF 1/2" 20h UNF	ZS67508
10	3/8" 9/16" 18h UNF 9/16" 18h UNF	ZS67510
12	1/2" 3/4" 16h UNF 3/4" 16h UNF	ZS67512
14-15-16	5/8" 7/8" 14h UNF 7/8" 14h UNF	ZS67516
18-20	3/4" 1" 1/16 12h UNF 1" 1/16 12h UNF	ZS67520
25	1" 1" 5/8 12h UNF 1" 5/8 12h UNF	ZS67525
30-32	1" 1/4 1" 5/8 12h UNF 1" 5/8 12h UNF	ZS67532
38	1" 1/2 1" 7/8 12h UNF 1" 7/8 12h UNF	ZS67538

Codo 90º macho JIC 37º - hembra fija NPT

90º Elbow male JIC 37º - fixed female NPT

Coude 90º JIC 37º - femelle fixe NPT

Adattatore a 90º maschio JIC 37º - femmina fissa NPT



TUBO PIPE	ROSCA THREAD	Referencia Part nº
6	1/4" 7/16" 20h UNF 1/4" NPT	ZS7000613
10	3/8" 9/16" 18h UNF 3/8" NPT	ZS7001017
12	1/2" 3/4" 16h UNF 1/2" NPT	ZS7001221
18-20	3/4" 1" 1/16 12h UNF 3/4" NPT	ZS7002026
25	1" 1" 5/8 12h UNF 1" NPT	ZS7002533

Codo 90º macho - macho JIC 37º con junta

90º Elbow male - male JIC 37º with o'ring

Coude 90º mâle - mâle JIC 37º avec o'ring

Adattatore a 90º maschio - maschio JIC 37º con o'ring



TUBO PIPE	ROSCA THREAD	Referencia Part nº
6	1/4" 7/16" 20h UNF	ZS500060R
8	5/16" 1/2" 20h UNF	ZS500080R
10	3/8" 9/16" 18h UNF	ZS500100R
12	1/2" 3/4" 16h UNF	ZS500120R
14-15-16	5/8" 7/8" 14h UNF	ZS500160R
18-20	3/4" 1" 1/16 12h UN	ZS500200R
25	1" 1" 5/8 12h UN	ZS500250R
30-32	1" 1/4 1" 5/8 12h UN	ZS500320R
38	1" 1/2 1" 7/8 12h UN	ZS500380R

Codo 90º pasatabiques macho - macho JIC 37º

90º Bulkhead elbow male - male JIC 37º

Coude 90º passe cloison mâle-mâle JIC 37º

Adattatore a 90º passaparete maschio - maschio JIC 37º



TUBO PIPE	ROSCA THREAD	Referencia Part nº
6	1/4" 7/16" - 20h UNF 7/16" - 20h UNF	ZS65006
8	5/16" 1/2" - 20h UNF 1/2" - 20h UNF	ZS65008
10	3/8" 9/16" - 18h UNF 9/16" - 18h UNF	ZS65010
12	1/2" 3/4" - 16h UNF 3/4" - 16h UNF	ZS65012
14-15-16	5/8" 7/8" - 14h UNF 7/8" - 14h UNF	ZS65016
18-20	3/4" 1" 1/16 - 12h UN 1" 1/16 - 12h UN	ZS65020
25	1" 1" 5/8 - 12h UN 1" 5/8 - 12h UN	ZS65025

Codo 90º regulable macho JIC 37º - macho BSP

90º Adjustable stud elbow male JIC 37º-male BSP

Coude 90º orientable mâle JIC 37º - mâle BSP

Adattatore 90º maschio orientabile BSP - maschio JIC 37º



TUBO PIPE	ROSCA THREAD	Referencia Part nº
6	1/4" 7/16" 20h UNF 1/4" BSP	ZS5700613
6	1/4" 1/2" 20h UNF 1/4" BSP	ZS5700813
10	3/8" 9/16 18h UNF 1/4" BSP	ZS5701013
10	3/8" 9/16" 18h UNF 3/8" BSP	ZS5701017
12	1/2" 3/4 20h UNF 3/8" BSP	ZS5701217
12	1/2" 3/4" 16h UNF 1/2" BSP	ZS5701221
14-15-16	5/8" 7/8" 14h UNF 1/2" BSP	ZS5701621
18-20	3/4" 1" 1/16 12h UN 3/4" BSP	ZS5702026
25	1" 1" 5/8 12h UN 1" BSP	ZS5702533
30-32	1" 1/4 1 5/8 12h UN 1" 1/4 BSP	ZS5703242
38	1" 1/2 1" 7/8 12h UN 1" 1/2 BSP	ZS5703848

CRIMPING FITTINGS
FOR HOSES

PIPE
FITTINGS

PIPE
FITTINGS II

ADAPTORS

WELDING
FITTINGS

INDUSTRIAL
FITTINGS

ACCESSORIES

CONTROL
COMPONENTS

FLOW
MEASURING

TRALE LOK

Racores JIC 37°

Flare fittings JIC 37°

Adaptateurs JIC 37°

Raccordi JIC 37°

Codo 90° regulable macho O'Ring Boss - macho JIC 37

90° Adjustable elbow male O'Ring Boss -male JIC 37°

Coude 90° orientable mâle O'Ring Boss - mâle JIC 37°

Adattatore 90° maschio orientabile O'ring Boss - maschio JIC 37°



Codo 90° macho JIC 37° - macho NPT

90° Elbow male JIC 37° - male NPT

Coude 90° mâle JIC 37° - mâle NPT

Adattatore a 90° maschio JIC 37° - maschio NPT



TUBO PIPE	ROSCA THREAD	Referencia Part n°	€
6	1/4" 7/16"-20h UNF	ZS57506	*
8	5/16" 1/2"-20h UNF	ZS57508	*
10	3/8" 9/16"-18h UNF	ZS57510	*
12	1/2" 3/4"-16h UNF	ZS57512	*
14-15-16	5/8" 7/8"-14h UNF	ZS57516	*
18-20	3/4" 1"1/16-12h UN	ZS57520	*
25	1" 1"5/16-12h UN	ZS57525	*

*Ver precios en p. 186 (ADAPTADORES O' RING BOSS) / *See prices in p. 186 (O' RING BOSS ADAPTORS) / *Voir prix à la p. 186 (ADAPTEURS O' RING BOSS) / *Vedere prezzi p. 186 (ADATTATORI O' RING BOSS)

TUBO PIPE	ROSCA THREAD	Referencia Part n°
6	1/4" 1/8" NPT 7/16" 20h UNF	ZS5250610
6	1/4" 1/4" NPT 7/16" 20h UNF	ZS5250613
8	5/16" 1/8" NPT 1/2" 20h UNF	ZS5250810
8	5/16" 1/4" NPT 1/2" 20h UNF	ZS5250813
10	3/8" 1/4" NPT 9/16" 18h UNF	ZS5251013
10	3/8" 3/8" NPT 9/16" 18h UNF	ZS5251017
10	3/8" 1/2" NPT 9/16" 18h UNF	ZS5251021
12	1/2" 1/4" NPT 3/4" 16h UNF	ZS5251213
12	1/2" 3/8" NPT 3/4" 16h UNF	ZS5251217
12	1/2" 1/2" NPT 3/4" 16h UNF	ZS5251221
14-15-16	5/8" 3/8" NPT 7/8" 14h UNF	ZS5251617
14-15-16	5/8" 1/2" NPT 7/8" 14h UNF	ZS5251621
14-15-16	5/8" 3/4" NPT 7/8" 14h UNF	ZS5251626
18-20	3/4" 1/2" NPT 1"1/16 12h UN	ZS5252021
18-20	3/4" 3/4" NPT 1"1/16 12h UN	ZS5252026
25	1" 3/4" NPT 1"5/16 12h UN	ZS5252526
25	1" 1" NPT 1"5/16 12h UN	ZS5252533

Codo 90° macho JIC 37° - macho BSPT

90° Elbow male JIC 37° - male BSPT

Coude 90° mâle JIC 37° - mâle BSPT

Adattatore a 90° maschio JIC 37° - maschio BSPT



TUBO PIPE	ROSCA THREAD	Referencia Part n°
6	1/4" 1/8" BSPT 7/16" 20h UNF	ZS5500610
6	1/4" 1/4" BSPT 7/16" 20h UNF	ZS5500613
8	5/16" 1/8" BSPT 1/2" 20h UNF	ZS5500810
8	5/16" 1/4" BSPT 1/2" 20h UNF	ZS5500813
10	3/8" 1/4" BSPT 9/16" 18h UNF	ZS5501013
10	3/8" 3/8" BSPT 9/16" 18h UNF	ZS5501017
10	3/8" 1/2" BSPT 9/16" 18h UNF	ZS5501021
12	1/2" 1/4" BSPT 3/4" 16h UNF	ZS5501213
12	1/2" 3/8" BSPT 3/4" 16h UNF	ZS5501217
12	1/2" 1/2" BSPT 3/4" 16h UNF	ZS5501221
14-15-16	5/8" 3/8" BSPT 7/8" 14h UNF	ZS5501617
14-15-16	5/8" 1/2" BSPT 7/8" 14h UNF	ZS5501621
14-15-16	5/8" 3/4" BSPT 7/8" 14h UNF	ZS5501626
18-20	3/4" 1/2" BSPT 1"1/16 12h UN	ZS5502021
18-20	3/4" 3/4" BSPT 1"1/16 12h UN	ZS5502026
25	1" 3/4" BSPT 1"5/16 12h UN	ZS5502526
25	1" 1" BSPT 1"5/16 12h UN	ZS5502533
30-32	1" 1/4" 1 1/4" BSPT 1"5/8 12h UN	ZS5503242*

*Hasta fin de existencias / Until end of stock / Jusqu'à la fin du stock / Fino ad esaurimento

Codo 90° macho NPT - hembra giratoria JIC 37°

90° Elbow male NPT - swivel female JIC 37°

Coude 90° mâle NPT - femelle tournante JIC 37°

Adattatore a 90° maschio NPT - femmina girevole JIC 37°



ROSCA THREAD	Referencia Part n°
1/8" NPT 7/16"-20h UNF	ZS5950610
1/4" NPT 1/2"-20h UNF	ZS5950813
1/4" NPT 9/16"-18h UNF	ZS5951013
3/8" NPT 3/4"-16h UNF	ZS5951217
1/2" NPT 7/8"-14h UNF	ZS5951621
3/4" NPT 1"1/16"-12h UN	ZS5952026
1" NPT 1"5/16"-12h UN	ZS5952533

Racores JIC 37°

Flare fittings JIC 37°

Adapteurs JIC 37°

Raccordi JIC 37°

Codo 45° macho JIC 37° - hembra giratoria JIC 37°

45° Elbow male JIC 37° - swivel female JIC 37°

Coude 45° mâle JIC 37° - femelle tournante JIC 37°

Adattatore a 45° maschio JIC 37° - femmina girevole JIC 37°



TUBO PIPE	ROSCA THREAD		Referencia Part n°	
6	1/4"	7/16" 20h UNF	7/16" 20h UNF	ZS69006
8	5/16"	1/2" 20h UNF	1/2" 20h UNF	ZS69008
10	3/8"	9/16" 18h UNF	9/16" 18h UNF	ZS69010
12	1/2"	3/4" 16h UNF	3/4" 16h UNF	ZS69012
14-15-16	5/8"	7/8" 14h UNF	7/8" 14h UNF	ZS69016
18-20	3/4"	1" 1/16 12h UN	1" 1/16 12h UN	ZS69020
25	1"	1" 5/16 12h UN	1" 5/16 12h UN	ZS69025

Codo 45° macho JIC 37° - macho NPT

45° Elbow male JIC 37° - male NPT pipe

Coude 45° mâle JIC 37° - mâle NPT

Adattatore a 45° maschio JIC 37° - maschio NPT



TUBO PIPE	ROSCA THREAD		Referencia Part n°	
6	1/4"	1/4" NPT	7/16" 20h UNF	ZS7250613
10	3/8"	3/8" NPT	9/16" 18h UNF	ZS7251017
12	1/2"	1/2" NPT	3/4" 16h UNF	ZS7251221
18-20	3/4"	3/4" NPT	1" 1/16 12h UN	ZS7252026
25	1"	1" NPT	1" 5/16 12h UN	ZS7252533

Codo 45° regulable macho - macho JIC 37°

45° Adjustable stud elbow male - male JIC 37°

Coude 45° orientable mâle - mâle JIC 37°

Adattatore a 45° orientabile maschio UNF - maschio JIC 37°



TUBO PIPE	ROSCA THREAD		Referencia Part n°	
6	1/4"	7/16" - 20h UNF	7/16" - 20h UNF	ZS77506
8	5/16"	1/2" - 20h UNF	1/2" - 20h UNF	ZS77508
10	3/8"	9/16" - 18h UNF	9/16" - 18h UNF	ZS77510
12	1/2"	3/4" - 16h UNF	3/4" - 16h UNF	ZS77512
14-15-16	5/8"	7/8" - 14h UNF	7/8" - 14h UNF	ZS77516
18-20	3/4"	1" 1/16 - 12h UN	1" 1/16 - 12h UN	ZS77520

CRIMPING FITTINGS
FOR HOSES

PIPE
FITTINGS

PIPE
FITTINGS II

ADAPTORS

WELDING
FITTINGS

INDUSTRIAL
FITTINGS

ACCESSORIES

CONTROL
COMPONENTS

FLOW
MEASURING

TRALE LOK

Racores JIC 37º

Flare fittings JIC 37º

Adapteurs JIC 37º

Raccordi JIC 37º

TE macho - macho - macho JIC 37º

Union tee male JIC 37º

Té égal mâle JIC 37º

Adattatore a T maschio JIC 37º



TUBO PIPE	ROSCA THREAD	Referencia Part nº	
6	1/4"	7/16" 20h UNF	ZS50506
8	5/16"	1/2" 20h UNF	ZS50508
10	3/8"	9/16" 18h UNF	ZS50510
12	1/2"	3/4" 16h UNF	ZS50512
14-15-16	5/8"	7/8" 14h UNF	ZS50516
18-20	3/4"	1"1/16 12h UN	ZS50520
25	1"	1"5/16 12h UN	ZS50525
30-32	1" 1/4	1"5/8 12h UN	ZS50532
38	1" 1/2	1"7/8 12h UN	ZS50538

TE macho - macho - macho JIC 37º con junta

Union tee male JIC 37º with o'ring

Té égal mâle JIC 37º avec o'ring

Adattatore a T maschio JIC 37º con o'ring



TUBO PIPE	ROSCA THREAD	Referencia Part nº	
6	1/4"	7/16" 20h UNF	ZS50506OR
8	5/16"	1/2" 20h UNF	ZS50508OR
10	3/8"	9/16" 18h UNF	ZS50510OR
12	1/2"	3/4" 16h UNF	ZS50512OR
14-15-16	5/8"	7/8" 14h UNF	ZS50516OR
18-20	3/4"	1"1/16 12h UN	ZS50520OR
25	1"	1"5/16 12h UN	ZS50525OR
30-32	1" 1/4	1"5/8 12h UN	ZS50532OR
38	1" 1/2	1"7/8 12h UN	ZS50538OR

TE macho - macho - hembra giratoria JIC 37º

Tee male JIC 37º - male JIC 37º - swivel nut JIC 37º

Té mâle JIC 37º - mâle JIC 37º - femelle tournante JIC 37º au latéral

Adattatore a T maschio - maschio - femmina girevole JIC 37º



TUBO PIPE	ROSCA THREAD	Referencia Part nº	
6	1/4"	7/16" 20h UNF	ZS68006
8	5/16"	1/2" 20h UNF	ZS68008
10	3/8"	9/16" 18h UNF	ZS68010
12	1/2"	3/4" 16h UNF	ZS68012
14-15-16	5/8"	7/8" 14h UNF	ZS68016
18-20	3/4"	1"1/16 12h UN	ZS68020
25	1"	1"5/16 12h UN	ZS68025
32	1" 1/4	1"5/8 12h UN	ZS68032
38	1" 1/2	1"7/8 12h UN	ZS68038

TE macho - hembra giratoria - macho JIC 37º

Tee male JIC 37º - swivel nut JIC 37º - male JIC 37º

Té mâle JIC 37º - femelle tournante JIC 37º - mâle JIC 37º

Adattatore a T maschio - femmina girevole - maschio JIC 37º



TUBO PIPE	ROSCA THREAD	Referencia Part nº	
6	1/4"	7/16" 20h UNF	ZS68506
8	5/16"	1/2" 20h UNF	ZS68508
10	3/8"	9/16" 18h UNF	ZS68510
12	1/2"	3/4" 16h UNF	ZS68512
14-15-16	5/8"	7/8" 14h UNF	ZS68516
18-20	3/4"	1"1/16 12h UN	ZS68520
25	1"	1"5/16 12h UN	ZS68525
32	1" 1/4	1"5/8 12h UN	ZS68532
38	1" 1/2	1"7/8 12h UN	ZS68538

TE macho JIC 37º - macho JIC 37º - macho NPT

Tee male JIC 37º - male JIC 37º - male NPT

Té mâle JIC 37º - mâle JIC 37º - mâle NPT

Adattatore a T maschio JIC 37º - maschio JIC 37º - maschio NPT



ROSCA THREAD	Referencia Part nº	
7/16"-20h UNF	7/16"-20h UNF 1/8" NPT	ZS6300610
1/2"-20h UNF	1/2"-20h UNF 1/4" NPT	ZS6300813
9/16"-18h UNF	9/16"-18h UNF 1/4" NPT	ZS6301013
3/4"-16h UNF	3/4"-16h UNF 3/8" NPT	ZS6301217
7/8"-14h UNF	7/8"-14h UNF 1/2" NPT	ZS6301621
1"1/16-12h UN	1"1/16-12h UN 3/4" NPT	ZS6302026
1"5/16-12h UN	1"5/16-12h UN 1" NPT	ZS6302533

TE macho JIC 37º - macho NPT - macho JIC 37º

Tee male JIC 37º - male NPT - male JIC 37º

Té mâle JIC 37º - mâle NPT - mâle JIC 37º

Adattatore a T maschio JIC 37º - maschio NPT - maschio JIC 37º



ROSCA THREAD	Referencia Part nº	
7/16"-20h UNF	1/8" NPT 7/16"-20h UNF	ZS6250610
1/2"-20h UNF	1/4" NPT 1/2"-20h UNF	ZS6250813
9/16"-18h UNF	1/4" NPT 9/16"-18h UNF	ZS6251013
3/4"-16h UNF	3/8" NPT 3/4"-16h UNF	ZS6251217
7/8"-14h UNF	1/2" NPT 7/8"-14h UNF	ZS6251621
1"1/16-12h UN	3/4" NPT 1"1/16-12h UN	ZS6252026
1"5/16-12h UN	1" NPT 1"5/16-12h UN	ZS6252533

Tubo TrΔle® SCH 143

SCH TrΔle® Rigid pipe
Tube rigide TrΔle® SCH
Tubo rigido TrΔle® SCH

Racores SCH - BUTT WELD 144

SCH BUTT WELD fittings
Raccords SCH - BUTT WELD
Raccordi SCH - BUTT WELDING

Racores SOCKET WELD 146

SOCKET WELD fittings
Raccords SOCKET WELD
Raccordi SOCKET WELD

Bridas SAE 148

SAE Flanges
Brides SAE
Flange SAE

Abrazaderas TrΔle® 155

TrΔle® Clamps
Colliers TrΔle®
Collari fissatubo TrΔle®



03

| TUBO RÍGIDO TRΔLE® SCH / RACORES SCH / BRIDAS SAE / ABRAZADERAS

SCH TrΔle® Rigid pipe/ SCH fittings / SAE Flanges / Clamps

Tube rigide SCH TrΔle® / Embouts SCH/ Brides SAE / Colliers

Tubo rigido TrΔle® SCH/Raccordi SCH/Flange SAE/Collari fissatubo

Tubo TrΔle® SCH

SCH TrΔle® Rigid pipe
Tube rigide TrΔle® SCH
Tubo rigido TrΔle® SCH

Tubo SCH10 ▪ Schedule 10 ▪ Schedule 10 ▪ Schedule 10

| 143



ZTH10

ZTH10...-3

Tubo SCH40 ▪ Schedule 40 ▪ Schedule 40 ▪ Schedule 40

| 143



ZTH40

ZTH40...-3

Racores SCH - BUTT WELD

SCH BUTT WELD fittings
Raccords SCH - BUTT WELD
Raccordi SCH - BUTT WELDING

Racores Tubo SCH - BW ■ SCH -BW Pipe Fittings ■ Raccords SCH - BW ■ Raccordi SCH - BW

144



ZS9010



ZST100



ZSR100



ZSC100



ZS9040



ZST400



ZSR400



ZSC400

CRIMPING FITTINGS
FOR HOSES

PIPE
FITTINGS

PIPE
FITTINGS II

ADAPTORS

WELDING
FITTINGS

INDUSTRIAL
FITTINGS

ACCESSORIES

CONTROL
COMPONENTS

FLOW
MEASURING

TRALE LOK

Racores SOCKET WELD

SOCKET WELD fittings
Raccords SOCKET WELD
Raccordi SOCKET WELD

Racores SOCKET WELD 3000 ▪ SOCKET WELD 3000 fittings ▪ Raccords SOCKET WELD 3000 ▪ SOCKET WELD 3000 raccordi

146



ZSW390



ZSW3C



ZSW3T



ZSW3CR



ZSW3M

Racores SOCKET WELD 6000 ▪ SOCKET WELD 6000 fittings ▪ Raccords SOCKET WELD 6000 ▪ SOCKET WELD 6000 raccordi

146



ZSW690



ZSW6M

Bridas SAE

SAE Flanges
Brides SAE
Flange SAE

Bridas para flexibles ▪ SAE Flanges for hoses ▪ Brides SAE pour flexibles ▪ Flange SAE per tubi flessibili | 148



ZBBP ZBBE ZBCE

Bridas roscadas ▪ Threaded flanges ▪ Brides taraudées ▪ Flange filettate | 149



ZBBRG ZBCRG ZB90RG

Bridas soldables tubo Gas ▪ Welding flanges for gas tube ▪ Brides à souder pour tube gaz ▪ Flange a saldare per tubo gas | 150



ZBB5G ZBC5G ZB905G

Bridas soldables tubo Métrico ▪ Welding flanges for metric tube ▪ Brides à souder pour tube métrique ▪ Flange a saldare per tubo Metrico | 151



ZBB5M ZBC5M ZB905M

Bridas ciegas ▪ Blind flanges ▪ Brides avec obturateur fermé ▪ Flange cieche | 152



ZBBC ZBCC

Conos soldar ▪ Welding adaptors for flanges ▪ Collets à souder ▪ Ogive a saldare | 153



ZB5M*1 ZB5G*1 ZB5M*0 ZB5G*0 ZB5W

Accesorios bridas ▪ Flange accessories ▪ Accessoires pour brides ▪ Accessori flange | 154



ZTB JBR ORING

Abrazaderas TrΔle®

TrΔle® Clamps
Colliers TrΔle®
Collari fissatubo TrΔle®

Abrazaderas completas serie ligera ▪ Complete clamps light serie ▪ Colliers complets série légère ▪ Collari fissatubo completo serie leggera

155



ZA40AZ

ZA40AZPL

ZA41AZ

ZA41AZPL

Componentes abrazaderas serie ligera ▪ Components for clamps light serie ▪ Composants pour colliers série légère ▪ Componenti per collari fissatubo serie leggera

156



A C

ZAPIN

ZAPS

ZAVTC

ZAVTE

ZAVTA

ZAPA

ZAPT

ZAPG

Dobles / paralelas ▪ Double clamp - parallel ▪ Colliers de fixation doubles ▪ Collari fissatubo doppi

159



ZAZCFS

ZADPIN

ZADPS

AD C

ZADVTE

ZADP

ZADVT

ZADAG

Abrazaderas serie pesada ▪ Clamps heavy serie ▪ Colliers série lourde ▪ Collari fissatubo serie pesante

161



ZAZCPS

AMPP C

ZAPINP

ZAPSP

ZAVTE

ZAPVTA

ZAPA

Accesorios abrazaderas ▪ Accesories for clamps ▪ Accessoires pour colliers ▪ Accessori per collari fissatubo

162



TC/TS

Tubo TrΔle® SCH

SCH TrΔle® Rigid pipe
 Tube rigide TrΔle® SCH
 Tubo rígido TrΔle® SCH

Tubo rígido SCH10 - AISI 316 - 6 METROS

SCH 10 rigid pipe - 6 metres- AISI 316

Tube rigide SCH10 - 6 metres- AISI 316

Tubo rígido SCH10 - AISI 316- 6 metri



DN	Ø EXT. Ø OUTER	Espesor (mm) Thickness (mm)	Referencia Part n°
1/2"	21,3	2,11	ZTH10SC008
3/4"	26,7	2,11	ZTH10SC012
1"	33,4	2,77	ZTH10SC016
1" 1/4	42,2	2,77	ZTH10SC020
1" 1/2	48,3	2,77	ZTH10SC024
2"	60,3	2,77	ZTH10SC032

Tubo rígido SCH10 - AISI 316 - 3 METROS

SCH 10 rigid pipe - 3 meters - AISI 316

Tube rigide SCH10 - 3 metres - AISI 316

Tubo rígido SCH10 - AISI 316 - 3 metri



DN	Ø EXT. Ø OUTER	Espesor (mm) Thickness (mm)	Referencia Part n°
1/2"	21,3	2,11	ZTH10SC008-3
3/4"	26,7	2,11	ZTH10SC012-3
1"	33,4	2,77	ZTH10SC016-3
1" 1/4	42,2	2,77	ZTH10SC020-3
1" 1/2	48,3	2,77	ZTH10SC024-3
2"	60,3	2,77	ZTH10SC032-3

Tubo rígido SCH40 - AISI 316 - 6 METROS

SCH 40 rigid pipe - 6 meters - AISI 316

Tube rigide SCH40 - 6 metres - AISI 316

Tubo rígido SCH40 - AISI 316 - 6 metri



DN	Ø EXT. Ø OUTER	Espesor (mm) Thickness (mm)	Referencia Part n°	€/M
1/2"	21,3	2,77	ZTH40SC008	47,17
3/4"	26,7	2,87	ZTH40SC012	61,76
1"	33,4	3,38	ZTH40SC016	82,48
1" 1/4	42,2	3,56	ZTH40SC020	97,02
1" 1/2	48,3	3,68	ZTH40SC024	123,41
2"	60,3	3,91	ZTH40SC032	187,51

Tubo rígido SCH40 - AISI 316 - 3 METROS

SCH 40 rigid pipe - 3 metres- AISI 316

Tube rigide SCH40 - 3 metres- AISI 316

Tubo rígido SCH40 - AISI 316 - 3 metri



DN	Ø EXT. Ø OUTER	Espesor (mm) Thickness (mm)	Referencia Part n°	€/M
1/2"	21,3	2,77	ZTH40SC008-3	49,53
3/4"	26,7	2,87	ZTH40SC012-3	64,84
1"	33,4	3,38	ZTH40SC016-3	86,61
1" 1/4	42,2	3,56	ZTH40SC020-3	101,87
1" 1/2	48,3	3,68	ZTH40SC024-3	129,58
2"	60,3	3,91	ZTH40SC032-3	196,89

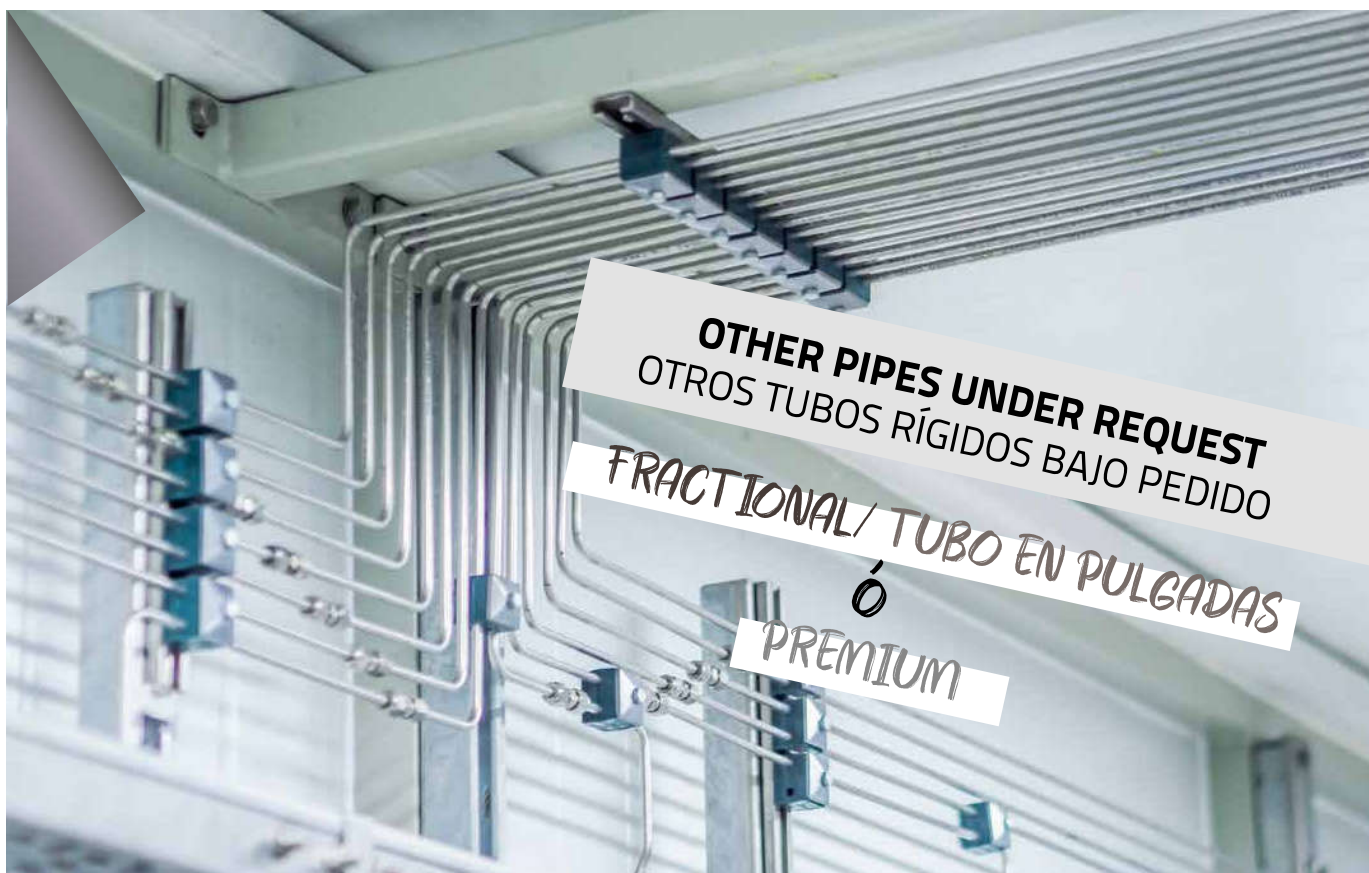

OTHER PIPES UNDER REQUEST
OTROS TUBOS RÍGIDOS BAJO PEDIDO

FRACTIONAL/ TUBO EN PULGADAS
Ó

PREMIUM

Racores SCH - BUTT WELD

SCH BUTT WELD fittings
Raccords SCH - BUTT WELD
Raccordi SCH - BUTT WELDING

Codo 90 SCH10

Elbow 90 Sch10

Coude 90 Sch10

Gomito 90 per Sch10



DN	Referencia Part n°
1/2"	ZS9010008
3/4"	ZS9010012
1"	ZS9010016
1" 1/4	ZS9010020
1" 1/2	ZS9010024
2"	ZS9010032

Te SCH10

Tee Sch10

Té Sch10

Raccordo a T Sch10



DN	Referencia Part n°
1/2"	ZST10008
3/4"	ZST10012
1"	ZST10016
1" 1/4	ZST10020
1" 1/2	ZST10024
2"	ZST10032

Reducción SCH10

Reduction Sch10

Réduction Sch10

Riduzione Sch10



DN	Referencia Part n°
3/4" - 1/2"	ZSR10012008
1" - 3/4"	ZSR10016012
1" 1/4 - 1"	ZSR10020016
1" 1/2 - 1" 1/4	ZSR10024020
2" - 1" 1/2	ZSR10032024

Tapón SCH10

Cap Sch10

Bouchon Sch 10

Tappo Sch10



DN	Referencia Part n°
1/2"	ZSC10008
3/4"	ZSC10012
1"	ZSC10016
1" 1/4	ZSC10020
1" 1/2	ZSC10024
2"	ZSC10032

Racores SCH - BUTT WELD

SCH BUTT WELD fittings
Raccords SCH - BUTT WELD
Raccordi SCH - BUTT WELDING

Codo 90 SCH40

Elbow 90 Sch40

Coude 90 Sch40

Gomito 90 per Sch40



DN	Referencia Part n°
1/2"	ZS9040008
3/4"	ZS9040012
1"	ZS9040016
1" 1/4	ZS9040020
1" 1/2	ZS9040024
2"	ZS9040032

Te Inox SCH40

Tee Sch40

Té Sch40

Raccordo a T Sch40



DN	Referencia Part n°
1/2"	ZST40008
3/4"	ZST40012
1"	ZST40016
1" 1/4	ZST40020
1" 1/2	ZST40024
2"	ZST40032

Reducción Inox SCH40

Reduction Sch40

Réduction Sch40

Riduzione Sch40



DN	Referencia Part n°
3/4" - 1/2"	ZSR40012008
1" - 3/4"	ZSR40016012
1" 1/4 - 1"	ZSR40020016
1" 1/2 - 1" 1/4	ZSR40024020
2" - 1" 1/2"	ZSR40032024

Tapón Inox SCH40

Cap Sch40

Bouchon Sch40

Tappo Sch40



DN	Referencia Part n°
1/2"	ZSC40008
3/4"	ZSC40012
1"	ZSC40016
1" 1/4	ZSC40020
1" 1/2	ZSC40024
2"	ZSC40032

CRIMPING FITTINGS
FOR HOSES

PIPE
FITTINGS

PIPE
FITTINGS II

ADAPTORS

WELDING
FITTINGS

INDUSTRIAL
FITTINGS

ACCESSORIES

CONTROL
COMPONENTS

FLOW
MEASURING

TRALE LOK

CRIMPING FITTINGS
FOR HOSES

PIPE
FITTINGS

PIPE
FITTINGS II

ADAPTORS

WELDING
FITTINGS

INDUSTRIAL
FITTINGS

ACCESSORIES

CONTROL
COMPONENTS

FLOW
MEASURING

TRALE LOK

Racores SOCKET WELD

SOCKET WELD fittings
Raccords SOCKET WELD
Raccordi SOCKET WELD

Racores SOCKET WELD 3000 Codo 90

SOCKET WELD 3000 fittings Elbow 90

Raccords SOCKET WELD 3000 Coude 90

Raccordo 90° SOCKET WELD 3000



DN	Referencia Part n°
1/2"	ZSW39008
3/4"	ZSW39012
1"	ZSW39016
1" 1/4	ZSW39020
1" 1/2	ZSW39024
2"	ZSW39032

Racores SOCKET WELD 3000 Manguito

SOCKET WELD 3000 Couplings Fittings

SOCKET WELD 3000 Accouplements Raccords

Manicotto SOCKET WELD 3000



DN	Referencia Part n°
1/2"	ZSW3M08
3/4"	ZSW3M12
1"	ZSW3M16
1" 1/4	ZSW3M20
1" 1/2	ZSW3M24
2"	ZSW3M32

Racores SOCKET WELD 3000 Cap

SOCKET WELD 3000 Cap Fittings

Raccords à chapeau SOCKET WELD 3000

Tappo SOCKET WELD 3000



DN	Referencia Part n°
1/2"	ZSW3C08
3/4"	ZSW3C12
1"	ZSW3C16
1" 1/4	ZSW3C20
1" 1/2	ZSW3C24
2"	ZSW3C32

Racores SOCKET WELD 6000 Codo 90

SOCKET WELD 6000 fittings Elbow 90

Raccords SOCKET WELD 6000 Coude 90

Raccordo 90° SOCKET WELD 6000



DN	Referencia Part n°
1/2"	ZSW69008
3/4"	ZSW69012
1"	ZSW69016
1" 1/4	ZSW69020

Racores SOCKET WELD 6000 Manguito

SOCKET WELD 6000 Couplings Fittings

SOCKET WELD 6000 Accouplements Raccords

Manicotto SOCKET WELD 6000



DN	Referencia Part n°
1/2"	ZSW6M08
3/4"	ZSW6M12
1"	ZSW6M16
1" 1/4	ZSW6M20

Racores SOCKET WEL 3000 Te

SOCKET WELD 3000 Tee fittings

Raccords en T SOCKET WELD 3000

Raccordo a T SOCKET WELD 3000



DN	Referencia Part n°
1/2"	ZSW3T08
3/4"	ZSW3T12
1"	ZSW3T16
1" 1/4	ZSW3T20
1" 1/2	ZSW3T24
2"	ZSW3T32

Racores SOCKET WELD 3000 Cruz

SOCKET WELD 3000 Cross Fittings

Raccords croix SOCKET WELD 3000

Raccordo a croce SOCKET WELD 3000



DN	Referencia Part n°	€
1/2"	ZSW3CR08	*
3/4"	ZSW3CR12	*
1"	ZSW3CR16	*
1" 1/4	ZSW3CR20	*
1" 1/2	ZSW3CR24	*
2"	ZSW3CR32	*

BRIDAS SAE

SAE flanges
Brides SAE
Flangia SAE

- **Características comunes**
Common characteristics
Données communes
Caratteristiche comuni

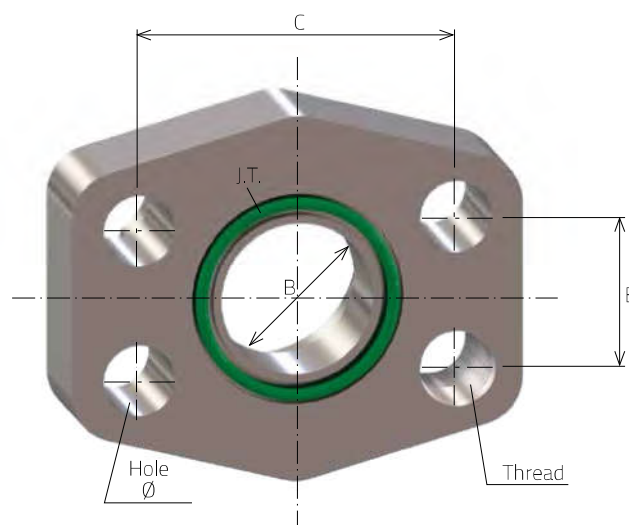

- **Bridas 3000 PSI**
Flanges 3000 PSI
Brides 3000 PSI
Flangia 3000 PSI

Tamaño	Max. pre.	B	C	E	O'ring NBR	Junta PU	Ø	Tornillo *	Rosca
1/2"	345 bar	13	38,1	17,48	18,64 x 3,53	JBR08	9	TB8X30	M8
3/4"	345 bar	19	47,63	22,23	24,99 x 3,53	JBR12	11	TB10X35	M10
1"	345 bar	25	52,37	26,19	32,92 x 3,53	JBR16	11	TB10X35	M10
1 1/4"	276 bar	32	58,72	30,18	37,70 x 3,53	JBR20	11,5	TB10X40	M10
1 1/2"	207 bar	38	69,85	35,71	47,22 x 3,53	JBR24	13,5	TB12X45	M12
2"	207 bar	51	77,77	42,88	56,74 x 3,53	JBR32	13,5	TB12X45	M12
2 1/2"	172 bar	63	88,9	50,8	66,27 x 3,53		13,5	TB12X45	M12
3"	138 bar	73	106,38	61,93	85,32 x 3,53		17,5	TB16X50	M16
3 1/2"	34 bar	89	120,65	69,85	98,02 x 3,53		17,5	TB16X50	M16
4"	34 bar	99	130,18	77,77	110,72 x 3,53		17,5	TB16X50	M16

- **Bridas 6000 PSI**
Flanges 6000 PSI
Brides 6000 PSI
Flangia 6000 PSI

Tamaño	Max. pre.	B	C	E	O'ring NBR	Junta PU	Ø	Tornillo *	Rosca
1/2"	414 bar	13	40,49	18,24	18,64 x 3,53	JBR08	9	TB8X30	M8
3/4"	414 bar	19	50,8	23,8	24,99 x 3,53	JBR12	11	TB10X40	M10
1"	414 bar	25	57,15	27,76	32,92 x 3,53	JBR16	13	TB12X45	M12
1 1/4"	414 bar	32	66,68	31,75	37,70 x 3,53	JBR20	15	TB14X45	M14
1 1/2"	414 bar	38	79,38	36,5	47,22 x 3,53	JBR24	17	TB16X50	M16
2"	414 bar	51	98,82	44,45	56,74 x 3,53	JBR32	21	TB20X70	M20

- * **Tornillos en acero carbono. Para tornillos en acero inoxidable, pedir ZTB...**
Screws are in carbon steel. For Stainless Steel screws, ask for ZTB... part number.
Les vis sont en acier carbone. Pour vis en acier inoxydable, veuillez demander les références ZTB ...
Le viti sono in acciaio al carbonio. Per viti in acciaio inox, ordinare con codice ZTB...

Bridas SAE

SAE Flanges
Brides SAE
Flange SAE

Brida partida pasante

SAE Split flange

Demi-bride passage total

Semiflangua SAE



Contrabrida roscada

SAE counter-flange

Contre-bride passage total

Controflangua SAE



SERIE SERIES	Ø INT. Ø INNER	TAMAÑO SIZE	Referencia Part n°	€
3000 PSI	30,2	1/2"	ZBBP308302	*
3000 PSI	38,1	3/4"	ZBBP312381	*
3000 PSI	44,5	1"	ZBBP316445	*
3000 PSI	50,8	1"1/4	ZBBP320508	*
3000 PSI	60,3	1"1/2	ZBBP324603	*
3000 PSI	71,4	2"	ZBBP332714	*
3000 PSI	84,1	2" 1/2	ZBBP340841	*
3000 PSI	102,4	3"	ZBBP3481024	*
3000 PSI	127	4"	ZBBP364127	*
6000 PSI	31,8	1/2"	ZBBP608318	*
6000 PSI	41,3	3/4"	ZBBP612413	*
6000 PSI	47,6	1"	ZBBP616476	*
6000 PSI	54	1"1/4	ZBBP620540	*
6000 PSI	63,5	1"1/2	ZBBP624635	*
6000 PSI	79,4	2"	ZBBP632794	*

SERIE SERIES	Ø INT. Ø INNER	TAMAÑO SIZE	Referencia Part n°	€
3000 PSI	30,2	1/2"	ZBCE308302	*
3000 PSI	38,1	3/4"	ZBCE312381	*
3000 PSI	44,5	1"	ZBCE316445	*
3000 PSI	50,8	1"1/4	ZBCE320508	*
3000 PSI	60,3	1"1/2	ZBCE324603	*
3000 PSI	71,4	2"	ZBCE332714	*
6000 PSI	31,8	1/2"	ZBCE608318	*
6000 PSI	41,3	3/4"	ZBCE612413	*
6000 PSI	47,6	1"	ZBCE616476	*
6000 PSI	54	1"1/4	ZBCE620540	*
6000 PSI	63,5	1"1/2	ZBCE624635	*
6000 PSI	79,4	2"	ZBCE632794	*

*Ver precios en p. 40 (CONEXIONES) / *See prices in p.40 (FITTINGS) / *Prix à la p.40 (EMBOUTS) / *Vedere prezzi p.40 (RACCORDI)

Brida entera pasante

SAE Flange

Bride monobloc passage total

Flangua monoblocco SAE



SERIE SERIES	Ø INT. Ø INNER	TAMAÑO SIZE	Referencia Part n°	€
3000 PSI	30,2	1/2"	ZBBE308302	*
3000 PSI	38,1	3/4"	ZBBE312381	*
3000 PSI	44,5	1"	ZBBE316445	*
3000 PSI	50,8	1"1/4	ZBBE320508	*
3000 PSI	60,3	1"1/2	ZBBE324603	*
3000 PSI	71,4	2"	ZBBE332714	*
3000 PSI	41	2" 1/2	ZBBE340841	*
3000 PSI	102,4	3"	ZBBE3481024	*
3000 PSI	127	4"	ZBBE364127	*
6000 PSI	31,8	1/2"	ZBBE608318	*
6000 PSI	41,3	3/4"	ZBBE612413	*
6000 PSI	47,6	1"	ZBBE616476	*
6000 PSI	54	1"1/4	ZBBE620540	*
6000 PSI	63,5	1"1/2	ZBBE624635	*
6000 PSI	79,4	2"	ZBBE632794	*

*Ver precios en p. 40 (CONEXIONES) / *See prices in p.40 (FITTINGS) / *Prix à la p.40 (EMBOUTS) / *Vedere prezzi p.40 (RACCORDI)

Bridas SAE

SAE Flanges
Brides SAE
Flange SAE

Brida roscada hembra BSP

BSP Female threaded flange

Bride taraudée femelle BSP

Flangia filettata femmina BSP



SERIE SERIES	ROSCA THREAD	TAMAÑO SIZE	Referencia Part n°
3000 PSI	1/2" BSP	1/2"	ZBBRG30808
3000 PSI	3/4" BSP	3/4"	ZBBRG31212
3000 PSI	1" BSP	1"	ZBBRG31616
3000 PSI	1"1/4 BSP	1"1/4	ZBBRG32020
3000 PSI	1"1/2 BSP	1"1/2	ZBBRG32424
3000 PSI	2" BSP	2"	ZBBRG33232
3000 PSI	2"1/2 BSP	2"1/2	ZBBRG34040
3000 PSI	3" BSP	3"	ZBBRG34848
3000 PSI	3"1/2 BSP	3"1/2	ZBBRG35656
3000 PSI	4" BSP	4"	ZBBRG36464
6000 PSI	1/2" BSP	1/2"	ZBBRG60808
6000 PSI	3/4" BSP	3/4"	ZBBRG61212
6000 PSI	1" BSP	1"	ZBBRG61616
6000 PSI	1"1/4 BSP	1"1/4	ZBBRG62020
6000 PSI	1"1/2 BSP	1"1/2	ZBBRG62424
6000 PSI	2" BSP	2"	ZBBRG63232

Contrabrida roscada hembra BSP

BSP Female threaded counter-flange

Contre-bride taraudée femelle BSP

Controflangia filettata femmina BSP



SERIE SERIES	ROSCA THREAD	TAMAÑO SIZE	Referencia Part n°
3000 PSI	1/2" BSP	1/2"	ZBCRG30808
3000 PSI	3/4" BSP	3/4"	ZBCRG31212
3000 PSI	1" BSP	1"	ZBCRG31616
3000 PSI	1"1/4 BSP	1"1/4	ZBCRG32020
3000 PSI	1"1/2 BSP	1"1/2	ZBCRG32424
3000 PSI	2" BSP	2"	ZBCRG33232
3000 PSI	2"1/2 BSP	2"1/2	ZBCRG34040
3000 PSI	3" BSP	3"	ZBCRG34848
3000 PSI	3"1/2 BSP	3"1/2	ZBCRG35656
3000 PSI	4" BSP	4"	ZBCRG36464
6000 PSI	1/2" BSP	1/2"	ZBCRG60808
6000 PSI	3/4" BSP	3/4"	ZBCRG61212
6000 PSI	1" BSP	1"	ZBCRG61616
6000 PSI	1"1/4 BSP	1"1/4	ZBCRG62020
6000 PSI	1"1/2 BSP	1"1/2	ZBCRG62424
6000 PSI	2" BSP	2"	ZBCRG63232

Brida codo 90° roscada hembra BSP

90° BSP female threaded flange

Bride 90° taraudée femelle BSP

Flangia a 90° filettata femmina BSP



SERIE SERIES	ROSCA THREAD	TAMAÑO SIZE	Referencia Part n°
3000 PSI	1/2" BSP	1/2"	ZB90RG30808
3000 PSI	3/4" BSP	3/4"	ZB90RG31212
3000 PSI	1" BSP	1"	ZB90RG31616
3000 PSI	1"1/4 BSP	1"1/4	ZB90RG32020
3000 PSI	1"1/2 BSP	1"1/2	ZB90RG32424
3000 PSI	2" BSP	2"	ZB90RG33232
6000 PSI	1/2" BSP	1/2"	ZB90RG60808
6000 PSI	3/4" BSP	3/4"	ZB90RG61212
6000 PSI	1" BSP	1"	ZB90RG61616
6000 PSI	1"1/4 BSP	1"1/4	ZB90RG62020
6000 PSI	1"1/2 BSP	1"1/2	ZB90RG62424

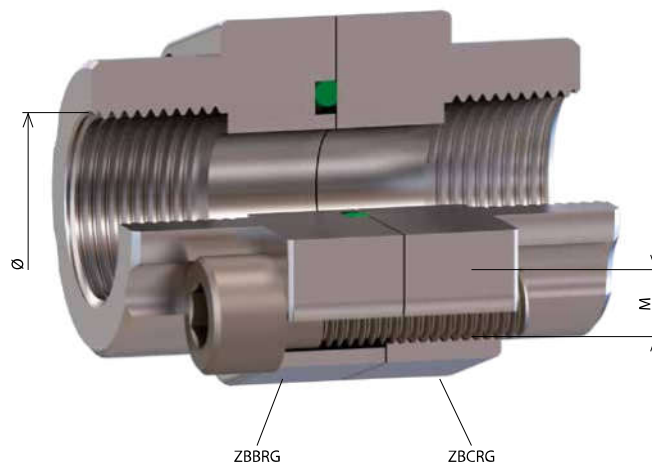

CRIMPING FITTINGS
FOR HOSES

PIPE
FITTINGS

PIPE
FITTINGS II

ADAPTORS

WELDING
FITTINGS

INDUSTRIAL
FITTINGS

ACCESSORIES

CONTROL
COMPONENTS

FLOW
MEASURING

TRALE LOK

Bridas SAE

SAE Flanges
Brides SAE
Flange SAE

Brida soldable hembra tubo gas

Welding female flange for gas tube

Bride à souder femelle tube gaz

Flangia a saldare di tasca per tubo gas



SERIE SERIES	Ø INT. Ø INNER	TAMAÑO SIZE	Referencia Part n°
3000 PSI	21,6	1/2"	ZBBSG308216
3000 PSI	27,2	3/4"	ZBBSG312272
3000 PSI	34,0	1"	ZBBSG316340
3000 PSI	42,8	1 1/4"	ZBBSG320428
3000 PSI	48,6	1 1/2"	ZBBSG324486
3000 PSI	61,0	2"	ZBBSG332610
3000 PSI	76,6	2 1/2"	ZBBSG340766
3000 PSI	90,5	3"	ZBBSG348905
3000 PSI	103,0	3 1/2"	ZBBSG3561030
3000 PSI	115,5	4"	ZBBSG3641155
6000 PSI	21,6	1/2"	ZBBSG608216
6000 PSI	27,2	3/4"	ZBBSG612272
6000 PSI	34,0	1"	ZBBSG616340
6000 PSI	42,8	1 1/4"	ZBBSG620428
6000 PSI	48,6	1 1/2"	ZBBSG624486
6000 PSI	61,0	2"	ZBBSG632610

Brida codo 90º soldable hembra tubo gas

90° welding female flange for gas tube

Bride 90° à souder femelle tube gaz

Flangia 90° a saldare di tasca per tubo gas



SERIE SERIES	Ø INT. Ø INNER	TAMAÑO SIZE	Referencia Part n°
3000 PSI	21,6	1/2"	ZB90SG308216
3000 PSI	27,2	3/4"	ZB90SG312272
3000 PSI	34,0	1"	ZB90SG316340
3000 PSI	42,8	1 1/4"	ZB90SG320428
3000 PSI	48,6	1 1/2"	ZB90SG324486
3000 PSI	61,0	2"	ZB90SG332610
6000 PSI	21,6	1/2"	ZB90SG608216
6000 PSI	27,2	3/4"	ZB90SG612272
6000 PSI	34,0	1"	ZB90SG616340
6000 PSI	42,8	1 1/4"	ZB90SG620428
6000 PSI	48,6	1 1/2"	ZB90SG624486

Contrabrida soldable hembra tubo gas

Welding female counter-flange for gas tube

Contre-bride à souder femelle tube gaz

Controflangia a saldare di tasca per tubo gas



SERIE SERIES	Ø INT. Ø INNER	TAMAÑO SIZE	Referencia Part n°
3000 PSI	21,6	1/2"	ZBCSG308216
3000 PSI	27,2	3/4"	ZBCSG312272
3000 PSI	34,0	1"	ZBCSG316340
3000 PSI	42,8	1 1/4"	ZBCSG320428
3000 PSI	48,6	1 1/2"	ZBCSG324486
3000 PSI	61,0	2"	ZBCSG332610
3000 PSI	76,6	2 1/2"	ZBCSG340766
3000 PSI	90,5	3"	ZBCSG348905
3000 PSI	103,0	3 1/2"	ZBCSG3561030
3000 PSI	115,5	4"	ZBCSG3641155
6000 PSI	21,6	1/2"	ZBCSG608216
6000 PSI	27,2	3/4"	ZBCSG612272
6000 PSI	34,0	1"	ZBCSG616340
6000 PSI	42,8	1 1/4"	ZBCSG620428
6000 PSI	48,6	1 1/2"	ZBCSG624486
6000 PSI	61,0	2"	ZBCSG632610

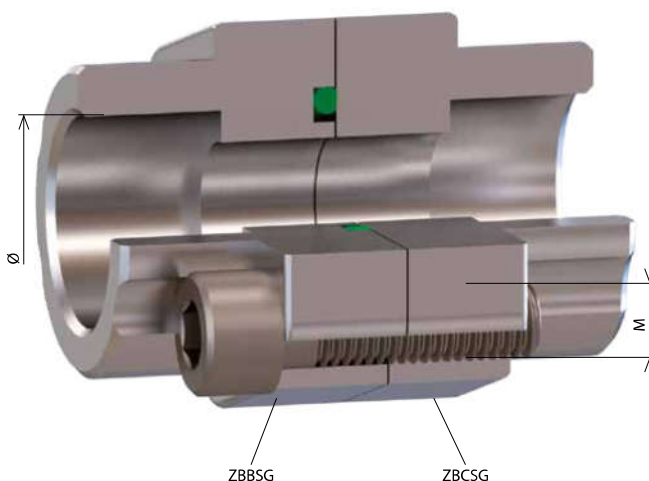

Bridas SAE

SAE Flanges
Brides SAE
Flange SAE

Brida soldable hembra tubo métrico

Female welding flange for metric tube

Bride à souder femelle tube métrique

Flangia a saldare di tasca per tubo metrico



SERIE SERIES	Ø INT. Ø INNER	TAMAÑO SIZE	Referencia Part n°
3000 PSI	20.3	1/2"	ZBBSM308203
3000 PSI	25.3	3/4"	ZBBSM312253
3000 PSI	30.3	1"	ZBBSM316303
3000 PSI	38.3	1"1/4	ZBBSM320383
3000 PSI	50.5	1"1/2	ZBBSM324505
6000 PSI	20.3	1/2"	ZBBSM608203
6000 PSI	25.3	3/4"	ZBBSM612253
6000 PSI	30.3	1"	ZBBSM616303
6000 PSI	38.3	1"1/4	ZBBSM620383
6000 PSI	50.5	1"1/2	ZBBSM624505

Contrabrida soldable hembra tubo métrico

Female welding counter-flange for metric tube

Contre-bride à souder femelle tube métrique

Controflangia a saldare di tasca per tubo metrico



SERIE SERIES	Ø INT. Ø INNER	TAMAÑO SIZE	Referencia Part n°
3000 PSI	20.3	1/2"	ZBCSM308203
3000 PSI	25.3	3/4"	ZBCSM312253
3000 PSI	30.3	1"	ZBCSM316303
3000 PSI	38.3	1"1/4	ZBCSM320383
3000 PSI	50.5	1"1/2	ZBCSM324505
6000 PSI	20.3	1/2"	ZBCSM608203
6000 PSI	25.3	3/4"	ZBCSM612253
6000 PSI	30.3	1"	ZBCSM616303
6000 PSI	38.3	1"1/4	ZBCSM620383
6000 PSI	50.5	1"1/2	ZBCSM624505

Brida codo 90º soldable Hembra tubo métrico

90° female welding flange for metric tube

Bride 90° à souder femelle tube métrique

Flangia 90° a saldare di tasca per tubo metrico



SERIE SERIES	Ø INT. Ø INNER	TAMAÑO SIZE	Referencia Part n°
3000 PSI	20.3	1/2"	ZB90SM308203
3000 PSI	25.3	3/4"	ZB90SM312253
3000 PSI	30.3	1"	ZB90SM316303
3000 PSI	38.3	1"1/4	ZB90SM320383
3000 PSI	50.5	1"1/2	ZB90SM324505
6000 PSI	20.3	1/2"	ZB90SM608203
6000 PSI	25.3	3/4"	ZB90SM612253
6000 PSI	30.3	1"	ZB90SM616303
6000 PSI	38.3	1"1/4	ZB90SM620383
6000 PSI	50.5	1"1/2	ZB90SM624505

BRIDAS SOLDABLES MACHO

Male welding flanges

Brides à souder mâle

Flangia a saldare maschio

■ Brida soldable macho tubo gas

Male welding flange for gas tube

Bride à souder mâle tube gaz

Flangia a saldare maschio tubo gas

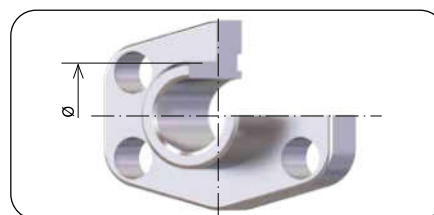

Ref: ZBMSG

■ Contrabrida macho soldable tubo gas

Male welding counterflange for gas tube

Contre-bride à souder mâle tube gaz

Controflangia a saldare maschio tubo gas

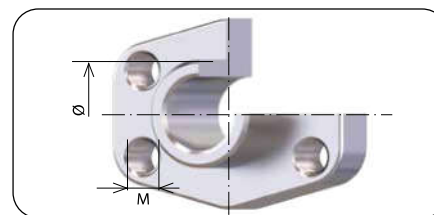

Ref: ZBCMSG

■ Brida soldable macho tubo métrico

Male welding flange for metric tube

Bride à souder mâle tube métrique

Flangia a saldare maschio tubo metrico

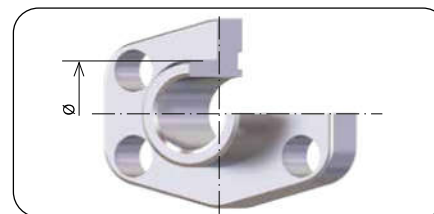

Ref: ZBMSM

■ Contrabrida macho soldable tubo métrico

Male welding counterflange for metric tube

Contre-bride à souder mâle tube métrique

Controflangia a saldare maschio tubo metrico

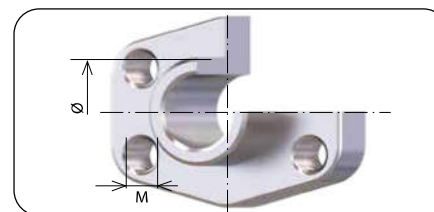

Ref: ZBCMSM

Bridas SAE

SAE Flanges
Brides SAE
Flange SAE

Bridas ciegas

Blind flanges

Brides avec obturateur fermé

Flangia cieca



Contrabridas ciegas

Blind counter-flanges

Contre-brides avec obturateur fermé

Controflangia cieca



SERIE SERIES	TAMAÑO SIZE	Referencia Part n°
3000 PSI	1/2"	ZBBC308
3000 PSI	3/4"	ZBBC312
3000 PSI	1"	ZBBC316
3000 PSI	1"1/4	ZBBC320
3000 PSI	1"1/2	ZBBC324
3000 PSI	2"	ZBBC332
3000 PSI	2"1/2	ZBBC340
3000 PSI	3"	ZBBC348
3000 PSI	3"1/2	ZBBC356
3000 PSI	4"	ZBBC364
6000 PSI	1/2"	ZBBC608
6000 PSI	3/4"	ZBBC612
6000 PSI	1"	ZBBC616
6000 PSI	1"1/4	ZBBC620
6000 PSI	1"1/2	ZBBC624
6000 PSI	2"	ZBBC632

SERIE SERIES	TAMAÑO SIZE	Referencia Part n°
3000 PSI	1/2"	ZBCC308
3000 PSI	3/4"	ZBCC312
3000 PSI	1"	ZBCC316
3000 PSI	1"1/4	ZBCC320
3000 PSI	1"1/2	ZBCC324
3000 PSI	2"	ZBCC332
3000 PSI	3"	ZBCC348
3000 PSI	3"1/2	ZBCC356
3000 PSI	4"	ZBCC364
6000 PSI	1/2"	ZBCC608
6000 PSI	3/4"	ZBCC612
6000 PSI	1"	ZBCC616
6000 PSI	1"1/4	ZBCC620
6000 PSI	1"1/2	ZBCC624
6000 PSI	2"	ZBCC632

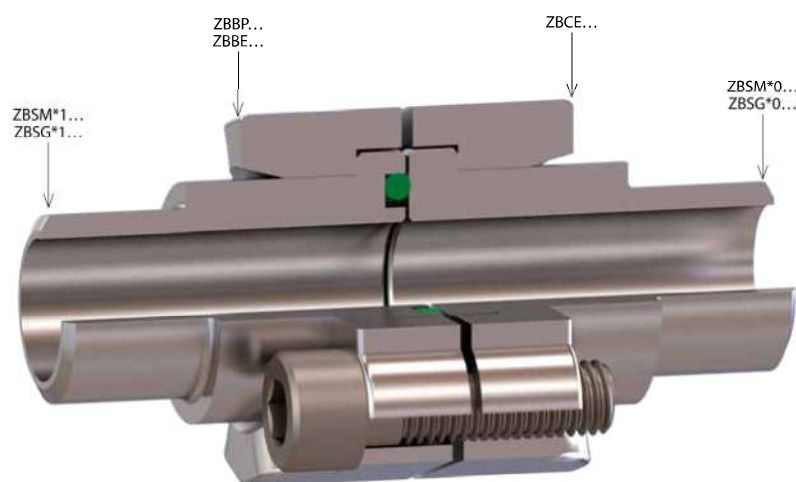

Bridas SAE

SAE Flanges
Brides SAE
Flange SAE

Brida cono soldable tubo métrico

Flange welding adaptor for metric tube

Bride collet à souder tube métrique

Adattatore a saldare per tubo Metrico con o'ring



SERIE SERIES	Ø EXT. Ø OUTER	TAMAÑO SIZE	Referencia Part n°
3000 PSI	16	1/2"	ZBSM3108016
3000 PSI	25	3/4"	ZBSM3112025
3000 PSI	30	1"	ZBSM3116030
3000 PSI	38	1"1/4	ZBSM3120038
3000 PSI	45	1"1/2	ZBSM3124045
3000 PSI	60	2"	ZBSM3132060
3000 PSI	70	2"1/2	ZBSM3140070
3000 PSI	80	3"	ZBSM3148080
3000 PSI	100	3"1/2	ZBSM3156100
3000 PSI	114.3	4"	ZBSM3164114
6000 PSI	16	1/2"	ZBSM6108016
6000 PSI	25	3/4"	ZBSM6112025
6000 PSI	30	1"	ZBSM6116030
6000 PSI	38	1"1/4	ZBSM6120038
6000 PSI	45	1"1/2	ZBSM6124045
6000 PSI	60	2"	ZBSM6132060

Brida cono soldable tubo gas

Flange welding adaptor for gas tube

Bride collet à souder tube gaz

Adattatore a saldare per tubo gas con o'ring



SERIE SERIES	Ø INT. Ø INNER	TAMAÑO SIZE	Referencia Part n°
3000 PSI	21.5	1/2"	ZBSG3108215
3000 PSI	28.0	3/4"	ZBSG3112280
3000 PSI	34.0	1"	ZBSG3116340
3000 PSI	42.8	1"1/4	ZBSG3120428
3000 PSI	48.6	1"1/2	ZBSG3124486
3000 PSI	61.0	2"	ZBSG3132610
6000 PSI	21.5	1/2"	ZBSG6108215
6000 PSI	28.0	3/4"	ZBSG6112280
6000 PSI	34.0	1"	ZBSG6116340
6000 PSI	42.8	1"1/4	ZBSG6120428
6000 PSI	48.6	1"1/2	ZBSG6124486
6000 PSI	61.0	2"	ZBSG6132610

Contrabrida cono soldable tubo métrico

Counter-flange welding adaptor for metric tube

Contre-bride collet à souder tube métrique

Adattatore a saldare per tubo Metrico senza o'ring



SERIE SERIES	Ø EXT. Ø OUTER	TAMAÑO SIZE	Referencia Part n°
3000 PSI	16	1/2"	ZBSM3008016
3000 PSI	25	3/4"	ZBSM3012025
3000 PSI	30	1"	ZBSM3016030
3000 PSI	38	1"1/4	ZBSM3020038
3000 PSI	45	1"1/2	ZBSM3024045
3000 PSI	60	2"	ZBSM3032060
3000 PSI	70	2"1/2	ZBSM3040070
3000 PSI	80	3"	ZBSM3048080
3000 PSI	100	3"1/2	ZBSM3056100
6000 PSI	16	1/2"	ZBSM6008016
6000 PSI	25	3/4"	ZBSM6012025
6000 PSI	30	1"	ZBSM6016030
6000 PSI	38	1"1/4	ZBSM6020038
6000 PSI	45	1"1/2	ZBSM6024045
6000 PSI	60	2"	ZBSM6032060

Contrabrida cono soldable tubo gas

Counter-flange welding adaptor for gas tube

Contre-bride collet à souder tube gaz

Adattatore a saldare per tubo gas senza o'ring



SERIE SERIES	Ø INT. Ø INNER	TAMAÑO SIZE	Referencia Part n°
3000 PSI	21.5	1/2"	ZBSG3008215
3000 PSI	28.0	3/4"	ZBSG3012280
3000 PSI	34.0	1"	ZBSG3016340
3000 PSI	42.8	1"1/4	ZBSG3020428
3000 PSI	48.6	1"1/2	ZBSG3024486
3000 PSI	61.0	2"	ZBSG3032610
6000 PSI	21.5	1/2"	ZBSG6008215
6000 PSI	28.0	3/4"	ZBSG6012280
6000 PSI	34.0	1"	ZBSG6016340
6000 PSI	42.8	1"1/4	ZBSG6020428
6000 PSI	48.6	1"1/2	ZBSG6024486
6000 PSI	61.0	2"	ZBSG6032610

Cabeza brida soldable SW tubo métrico

Welding flange head SW metric tube

Tête de bride de soudage SW tube métrique

Flangia a saldare di testa per tubo metrico SW



SERIE SERIES	TUBO PIPE	TAMAÑO SIZE	Referencia Part n°
3000 PSI	14	1/2"	ZBSWM3108014
3000 PSI	22	3/4"	ZBSWM3112022
3000 PSI	50	2"	ZBSWM3132050
6000 PSI	22	3/4"	ZBSWM6112022
6000 PSI	28	1"	ZBSWM6116028
6000 PSI	35	1"1/4	ZBSWM6120035
6000 PSI	39	1"1/2	ZBSWM6124039

Hasta fin de existencias / Until end of stock / Jusqu'à la fin du stock / Fino ad esaurimento

Bridas SAE

SAE Flanges
Brides SAE
Flange SAE

Tornillos para bridas SAE

Screws for SAE flanges

Vis pour brides SAE

Vite per flangia SAE



ROSCA THREAD	TAMAÑO SIZE	Referencia Part n°
M8X30	3000-6000 PSI 1/2"	ZTB8X30
M10X35	3000 PSI 3/4"-1"	ZTB10X35
M10X40	3000 PSI 1" 1/4 - 6000 PSI 3/4"	ZTB10X40
M12X45	3000 PSI 1"1/2-2"-2"1/2-6000 PSI 1"	ZTB12X45
M14X45	6000 PSI 1"1/4	ZTB14X45
M16X50	3000 PSI 3"-3"1/2"-4"- 6000 PSI 1" 1/2	ZTB16X50
M20X70	6000 PSI 2"	ZTB20X70

Juntas para bridas SAE 3000/6000 PSI

Seals for 3000/6000 PSI flange

Joints pour bride série 3000/6000

Guarnizioni per flangia SAE 3000/6000 PSI



TAMAÑO SIZE	Ø INT. Ø INNER	Ø EXT. Ø OUTER	Referencia Part n°	€
1/2"	17,02	25,40	JBR08	*
3/4"	23,36	31,72	JBR12	*
1"	31,24	39,62	JBR16	*
1"1/4	36,07	44,45	JBR20	*
1"1/2	45,34	53,98	JBR24	*
2"	54,86	63,50	JBR32	*

*Ver precios en Conducciones Hidráulicas y Neumáticas / *See prices in Hydraulic and Pneumatic Connectors' Catalogue / *Voir prix dans le Catalogue Connectique Hydraulique et Pneumatique / *Vedere prezzi nel listino Conduzioni Idrauliche e Pneumatiche

Juntas tóricas para bridas SAE 3000/6000 PSI

O-rings for 3000/6000 PSI flange

O-rings pour bride série 3000/6000 PSI

O-rings per flangia SAE 3000/6000 PSI



TAMAÑO SIZE	Ø INT. Ø INNER	Referencia Part n°	€
1/2"	18,64	18.64X3.53	*
3/4"	24,99	24.99X3.53	*
1"	32,92	32.92X3.53	*
1"1/4	37,70	37.70X3.53	*
1"1/2	47,22	47.22X3.53	*
2"	56,74	56.74X3.53	*

*Ver precios en Conducciones Hidráulicas y Neumáticas / *See prices in Hydraulic and Pneumatic Connectors' Catalogue / *Voir prix dans le Catalogue Connectique Hydraulique et Pneumatique / *Vedere prezzi nel listino Conduzioni Idrauliche e Pneumatiche

Abrazaderas TrΔle®

TrΔle® Clamps
Colliers TrΔle®
Collari fissatubo TrΔle®

Abrazadera ligera simple completa

Light serie simple clamp

Collier de fixation simple complet, série légère

Collare verde singolo completo (serie leggera)

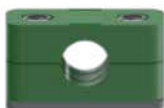

DN	GRUPO GROUP	Referencia Part n°
6	1	ZA40AZ06
8	1	ZA40AZ08
10	1	ZA40AZ10
12	1	ZA40AZ12
14	2	ZA40AZ14
15	2	ZA40AZ15
16	2	ZA40AZ16
18	2	ZA40AZ18
20	3	ZA40AZ20
22	3	ZA40AZ22
23	3	ZA40AZ23
25	3	ZA40AZ25
28	4	ZA40AZ28
30	4	ZA40AZ30
38	5	ZA40AZ38
40	5	ZA40AZ40
42-1"1/4	5	ZA40AZ42

Abrazadera ligera simple completa, plásticos perfil liso

Light serie simple clamp, plastic smooth profile

Collier de fixation simple série légère, complet, plastic profil lisse

Collare verde liscio singolo completo



DN	GRUPO GROUP	Referencia Part n°
8	1	ZA40AZ08PL
10	1	ZA40AZ10PL
12	1	ZA40AZ12PL
1/4"	2	ZA40AZ13.2PL
15	2	ZA40AZ15PL
3/8"	2	ZA40AZ16.7PL
18	2	ZA40AZ18PL
20	3	ZA40AZ20PL
1/2"	3	ZA40AZ21.3PL
22	3	ZA40AZ22PL
25	3	ZA40AZ25PL
3/4"	4	ZA40AZ26.7PL
28	4	ZA40AZ28PL
30	4	ZA40AZ30PL
1"	5	ZA40AZ33.3PL
35	5	ZA40AZ35PL
38	5	ZA40AZ38PL
42-1" 1/4	5	ZA40AZ42PL

Abrazadera ligera reforzada completa

Light serie reinforced clamp

Collier de fixation simple série légère renforcé complet

Collare verde singolo completo (serie leggera rinforzata)

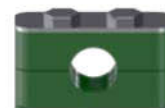

DN	GRUPO GROUP	Referencia Part n°
6	1	ZA41AZ06
8	1	ZA41AZ08
10	1	ZA41AZ10
12	1	ZA41AZ12
1/4"	2	ZA41AZ13.2
14	2	ZA41AZ14
15	2	ZA41AZ15
16	2	ZA41AZ16
18	2	ZA41AZ18
20	3	ZA41AZ20
22	3	ZA41AZ22
23	3	ZA41AZ23
25	3	ZA41AZ25
28	4	ZA41AZ28
30	4	ZA41AZ30
38	5	ZA41AZ38
40	5	ZA41AZ40
42-1"1/4	5	ZA41AZ42

Abrazadera ligera reforzada completa, plásticos perfil

Light serie reinforced clamp, plastic smooth profile

Collier de fixation simple série légère renforcé, complet, plastic profil lisse

Collare verde liscio singolo completo (serie leggera rinforzata)



DN	GRUPO GROUP	Referencia Part n°
8	1	ZA41AZ08PL
10	1	ZA41AZ10PL
12	1	ZA41AZ12PL
1/4"	2	ZA41AZ13.2PL
15	2	ZA41AZ15PL
3/8"	2	ZA41AZ16.7PL
18	2	ZA41AZ18PL
20	3	ZA41AZ20PL
1/2"	3	ZA41AZ21.3PL
22	3	ZA41AZ22PL
25	3	ZA41AZ25PL
3/4"	4	ZA41AZ26.7PL
28	4	ZA41AZ28PL
30	4	ZA41AZ30PL
1"	5	ZA41AZ33.3PL
35	5	ZA41AZ35PL
38	5	ZA41AZ38PL
42-1" 1/4	5	ZA41AZ42PL

Abrazaderas TrΔle®

TrΔle® Clamps
Colliers TrΔle®
Collari fissatubo TrΔle®

Plásticos polipropileno, serie ligera

Plastics polypropylene, light serie

Plastique polypropylène, série légère

Collare singolo polipropilene verde (serie leggera)



DN	GRUPO GROUP	Referencia Part n°	€
6	1	A106C	*
8	1	A108C	*
10	1	A110C	*
12	1	A112C	*
1/4"	2	A213.2C	*
14	2	A214C	*
15	2	A215C	*
3/8"	2	A216.7C	*
16	2	A216C	*
18	2	A218C	*
19	3	A319C	*
20	3	A320C	*
1/2"	3	A321.3C	*
22	3	A322C	*
23	3	A323C	*
25	3	A325C	*
3/4"	4	A426.7C	*
28	4	A428C	*
30	4	A430C	*
32	5	A532C	*
1"	5	A533.7C	*
35	5	A535C	*
38	5	A538C	*
40	5	A540C	*
42-1"1/4	5	A542C	*
44,5	6	A644.5C	*
1"1/2	6	A648.3C	*
50,8	6	A650.8C	*

*Precio por pareja. Ver precios en Tarifa Conducciones Hidráulicas y Neumáticas / *Price per couple. See prices in Hydraulic and Pneumatic Connectors' Catalogue / *Prix par paire. Voir les prix dans le Catalogue Connectique Hydraulique et Pneumatique / *Prezzo per coppia. Vedere prezzi nel listino Conduitture Idrauliche e Pneumatiche

Chapas inferiores, serie ligera

Lower plate, light serie

Plaque inférieure, série légère

Piastra inferiore (serie leggera)



GRUPO GROUP	Referencia Part n°
1	ZAPIN1
2	ZAPIN2
3	ZAPIN3
4	ZAPIN4
5	ZAPIN5
6	ZAPIN6

Chapas superiores, serie ligera

Upper plate, light serie

Plaque supérieure, série légère

Piastra superiore (serie leggera)



GRUPO GROUP	Referencia Part n°
1	ZAPS1
2	ZAPS2
3	ZAPS3
4	ZAPS4
5	ZAPS5
6	ZAPS6

Tornillos Allen, serie ligera

Allen screw, light serie

Vis Allen, série légère

Vite Allen



ROSCA THREAD	GRUPO GROUP	Referencia Part n°
M6	1	ZAVTC1
M6	2	ZAVTC2
M6	3	ZAVTC3
M6	4	ZAVTC4
M6	5	ZAVTC5
M6	6	ZAVTC6

Precio por unidad / Price per unit / Prix à l'unité / Prezzo unitario

Tornillos Hexagonales, serie ligera

Hexagonal screw, light serie

Vis Hexagonnel, série légère

Vite esagonale



ROSCA THREAD	GRUPO GROUP	Referencia Part n°
M6	1	ZAVTE1
M6	2	ZAVTE2
M6	3	ZAVTE3
M6	4	ZAVTE4
M6	5	ZAVTE5
M6	6	ZAVTE6

Precio por unidad / Price per unit / Prix à l'unité / Prezzo unitario

Abrazaderas TrΔle®

TrΔle® Clamps
 Colliers TrΔle®
 Collari fissatubo TrΔle®

Tornillos Apilar Inox Serie Ligera

Stainless Steel Stack Screws Light Series

Vis de pile en acier inoxydable série légère

Vite inox (serie leggera componibile)



ROSCA THREAD	GRUPO GROUP	Referencia Part n°
M6	1	ZAVTA1
M6	2	ZAVTA2
M6	3	ZAVTA3
M6	4	ZAVTA4
M6	5	ZAVTA5
M6	6	NEW ZAVTA6

Chapas para apilar abrazaderas, serie ligera

Plates to pile up clamps, light serie

Plaques pour empiler colliers, série légère

Piastra componibile (serie leggera)



GRUPO GROUP	Referencia Part n°
1	ZAPA1
2	ZAPA2
3	ZAPA3
4	ZAPA4
5	ZAPA5
6	ZAPA6

TRALE®

ABRAZADERAS | CLAMPS

UNE TUS SISTEMAS DE TUBERÍA DE FORMA SEGURA

JOIN PIPE SYSTEMS SECURELY

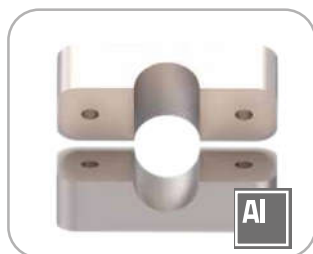
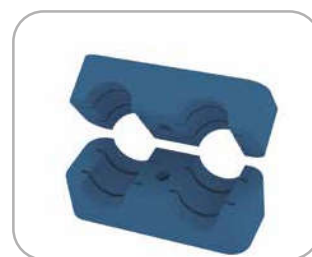

CONSULTA EL
CATÁLOGO DE
CONDUCCIONES



CHECK OUR
CONNECTORS
CATALOGUE

Abrazaderas TrΔle®

TrΔle® Clamps
Colliers TrΔle®
Collari fissatubo TrΔle®

Chapa Atornillar, Serie ligera

Elongated Weld Plate Light Series

Plaque à souder allongée, série légère

Piastra inferiore con fori di fissaggio (serie leggera)



GRUPO GROUP	Referencia Part n°
1	ZAPT1
2	ZAPT2
3	ZAPT3
4	ZAPT4
5	ZAPT5
6	ZAPT6



Chapa Agrupar Inox Serie Ligera



Stainless Steel Jointed plate Light Series

Plaque à joindre acier inoxydable série légère

Piastra inferiore multipla (serie leggera)



GRUPO GROUP	Nº ABRAZ CLAMP QTY.	Referencia Part n°
1	10	ZAPAG1
2	10	ZAPAG2
3	10	ZAPAG3
4	10	ZAPAG4
5	10	ZAPAG5
6	10	ZAPAG6

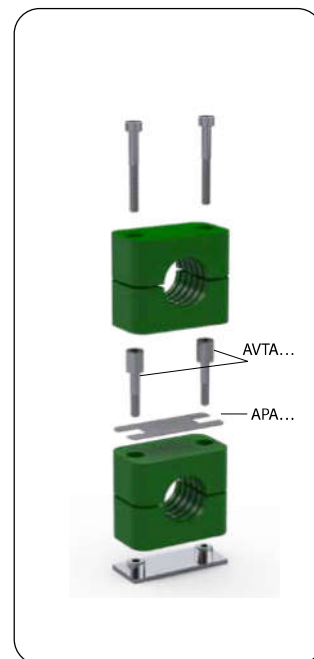
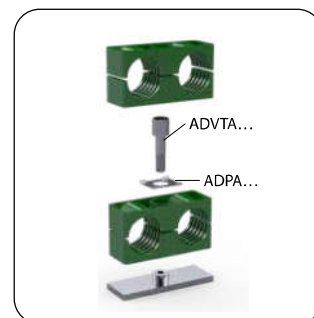

Abrazaderas TrΔle®

TrΔle® Clamps
Colliers TrΔle®
Collari fissatubo TrΔle®

Abrazaderas dobles completas

Double clamp - parallel

Colliers de fixation doubles complets

Collare verde doppio completo



DN	GRUPO GROUP	Referencia Part n°
6	1	ZAZCFS06
8	1	ZAZCFS08
10	1	ZAZCFS10
12	1	ZAZCFS12
14	2	ZAZCFS14
15	2	ZAZCFS15
16	2	ZAZCFS16
18	2	ZAZCFS18
20	3	ZAZCFS20
22	3	ZAZCFS22
25	3	ZAZCFS25
28	4	ZAZCFS28
30	4	ZAZCFS30
35	5	ZAZCFS35
38	5	ZAZCFS38
40	5	ZAZCFS40
42	5	ZAZCFS42

Chapas inferiores

Double Lower plate

Plaques inférieures à souder double

Piastra inferiore (collare doppio)



ROSCA THREAD	GRUPO GROUP	Referencia Part n°
M6	1	ZADPIN1
M8	2	ZADPIN2
M8	3	ZADPIN3
M8	4	ZADPIN4
M8	5	ZADPIN5

Chapas superiores

Double Upper plate

Plaques supérieures de protection double

Piastra superiore (collare doppio)



GRUPO GROUP	Referencia Part n°
1	ZADPS1
2	ZADPS2
3	ZADPS3
4	ZADPS4
5	ZADPS5

Plásticos polipropileno dobles

Double plastics polypropylene

Plastiques polypropylene doubles

Collare doppio polipropilene verde



DN	GRUPO GROUP	Referencia Part n°	€
6	1	AD106C	*
8	1	AD108C	*
10	1	AD110C	*
12	1	AD112C	*
1/4"	2	AD213.2C	*
14	2	AD214C	*
15	2	AD215C	*
3/8"	2	AD216.7C	*
16	2	AD216C	*
18	2	AD218C	*
19	3	AD319C	*
20	3	AD320C	*
1/2"	3	AD321.3C	*
22	3	AD322C	*
25	3	AD325C	*
3/4"	4	AD426.7C	*
28	4	AD428C	*
30	4	AD430C	*
32	5	AD532C	*
1"	5	AD533.3C	*
35	5	AD535C	*
38	5	AD538C	*
40	5	AD540C	*
42	5	AD542C	*

*Precio por pareja. Ver precios en Tarifa Conducciones Hidráulicas y Neumáticas / *Price per couple. See prices in Hydraulic and Pneumatic Connectors' Catalogue / *Prix par paire. Voir les prix dans le Catalogue Connectique Hydraulique et Pneumatique / *Prezzo per coppia. Vedere prezzi nel listino Conduzioni Idrauliche e Pneumatiche

Tornillos cabeza hexagonal

Hexagonal screw

Vis hexagonale

Vite esagonale (collare doppio)



ROSCA THREAD	GRUPO GROUP	Referencia Part n°
M6	1	ZADVTE1
M8	2	ZADVTE2
M8	3	ZADVTE3
M8	4	ZADVTE4
M8	5	ZADVTE5

Precio por unidad / Price per unit / Prix à l'unité / Prezzo unitario

Abrazaderas TrΔle®

TrΔle® Clamps
Colliers TrΔle®
Collari fissatubo TrΔle®

Chapa apilar abrazadera doble



Plates to pile up double clamps

Plaques pour empiler colliers doubles

Piastra serie componibile (collare doppio)



GRUPO GROUP	Referencia Part n°	€
1	ZADPA1	
2/3/4/5	ZADPA2	

Chapa agrupar abrazadera doble



Jointed plate double clamps

Plaque à joindre colliers doubles

Piastra multipla (collare doppio)



ROSCA THREAD	GRUPO GROUP	Nº ABRAZADERAS CLAMP QTY.	Referencia Part n°
M6	1	5	ZADPAG1
M8	2	5	ZADPAG2
M8	3	5	ZADPAG3

Tornillo apilar abrazadera doble



Stack Screws double clamps

Vis de pile colliers doubles

Vite inox (serie componibile collare doppio)



ROSCA THREAD	GRUPO GROUP	Referencia Part n°
M6	2	ZADVTA2
M6	3	ZADVTA3
M6	4	ZADVTA4
M6	5	ZADVTA5
M6	6	ZADVTA6

Para Grupo 1: ZAVTA1 (ligera) / For Group 1: ZAVTA1 (Light) / Pour le Groupe 1: ZAVTA1 (léger) *ruppo*
1: ZAVTA1 (leggera)

Abrazaderas TrΔle®

TrΔle® Clamps
Colliers TrΔle®
Collari fissatubo TrΔle®

Abrazaderas Inox Serie pesada completas

Heavy Series Stainless Steel Clamps

Pinces en acier inoxydable série lourde

Collare singolo completo (serie pesante)



DN	GRUPO GROUP	Referencia Part n°
6	1	ZAZCPS06
8	1	ZAZCPS08
10	1	ZAZCPS10
12	1	ZAZCPS12
1/4"	1	ZAZCPS13.2
14	1	ZAZCPS14
15	1	ZAZCPS15
16	1	ZAZCPS16
3/8"	1	ZAZCPS17.2
18	1	ZAZCPS18
20	2	ZAZCPS20
1/2"	2	ZAZCPS21.3
22	2	ZAZCPS22
25	2	ZAZCPS25
3/4"	2	ZAZCPS26.7
28	2	ZAZCPS28
30	2	ZAZCPS30
32	3	ZAZCPS32
1"	3	ZAZCPS33.3
35	3	ZAZCPS35
38	3	ZAZCPS38
40	3	ZAZCPS40
42 - 1" 1/4	3	ZAZCPS42
45	4	ZAZCPS45
48-1" 1/2	4	ZAZCPS48
50	4	ZAZCPS50
55	4	ZAZCPS55
2"	4	ZAZCPS60.3
65	4	ZAZCPS65
70	4	ZAZCPS70

Plásticos polipropileno, serie pesada

Plastics polypropylene, heavy serie

Plastique polypropylene, série lourde

Collare singolo polipropilene verde (serie pesante)



DN	GRUPO GROUP	Referencia Part n°	€
6	1	AMPP106C	*
8	1	AMPP108C	*
10	1	AMPP110C	*
12	1	AMPP112C	*
1/4"	1	AMPP113.2C	*
14	1	AMPP114C	*
15	1	AMPP115C	*
16	1	AMPP116C	*
3/8"	1	AMPP117.2C	*
18	1	AMPP118C	*
20	2	AMPP220C	*
1/2"	2	AMPP221.3C	*
22	2	AMPP222C	*
25	2	AMPP225C	*
3/4"	2	AMPP226.7C	*
28	2	AMPP228C	*
30	2	AMPP230C	*
30	3	AMPP330C	*
32	3	AMPP332C	*
1"	3	AMPP333.3C	*
35	3	AMPP335C	*
38	3	AMPP338C	*
40	3	AMPP340C	*
42	3	AMPP342C	*
38	4	AMPP438C	*
42-1" 1/4	4	AMPP442C	*
45	4	AMPP445C	*
48-1" 1/2	4	AMPP448C	*
50	4	AMPP450C	*
55	4	AMPP455C	*
2"	4	AMPP460.3C	*
65	4	AMPP465C	*
70	4	AMPP470C	*

*Precio por pareja. Ver precios en Tarifa Conducciones Hidráulicas y Neumáticas / *Price per couple. See prices in Hydraulic and Pneumatic Connectors' Catalogue / *Prix par paire. Voir les prix dans le Catalogue Connectique Hydraulique et Pneumatique / *Prezzo per coppia. Vedere prezzi nel listino Conduzione Idrauliche e Pneumatiche

CRIMPING FITTINGS
FOR HOSES

PIPE
FITTINGS

PIPE
FITTINGS II

ADAPTORS

WELDING
FITTINGS

INDUSTRIAL
FITTINGS

ACCESSORIES

CONTROL
COMPONENTS

FLOW
MEASURING

TRALE LOK

Abrazaderas TrΔle®

TrΔle® Clamps
Colliers TrΔle®
Collari fissatubo TrΔle®

Chapas inferiores, serie pesada

Lower plate, heavy serie

Plaque inférieure, série lourde

Piastra inferiore (serie pesante)



ROSCA THREAD	GRUPO GROUP	Referencia Part n°
M10	1	ZAPINP1
M10	2	ZAPINP2
M10	3	ZAPINP3
M12	4	ZAPINP4

Chapas superiores, serie pesada

Upper plate, heavy serie

Plaque supérieure, série lourde

Piastra superiore (serie pesante)



GRUPO GROUP	Referencia Part n°
1	ZAPSP1
2	ZAPSP2
3	ZAPSP3
4	ZAPSP4

Tornillos, serie pesada

Screw, heavy serie

Vis, série lourde

Vite (serie pesante)



ROSCA THREAD	GRUPO GROUP	Referencia Part n°
M10	1	ZAVTEP1
M10	2	ZAVTEP2
M10	3	ZAVTEP3
M12	4	ZAVTEP4

Precio por unidad / Price per unit / Prix à l'unité / Prezzo unitario

Tornillo apilar serie pesada

Stack Screws, heavy serie

Vis de pile, série lourde

Vite Inox (serie pesante componibile)



ROSCA THREAD	GRUPO GROUP	Referencia Part n°
M10	1	ZAPVTAP1
M10	2	ZAPVTAP2
M10	3	ZAPVTAP3
M12	4	ZAPVTAP4

NEW

Chapa apilar serie pesada

Plates to pile up clamps, heavy serie

Plaques pour empiler colliers, série lourde

Piastra componibile (serie pesante)



GRUPO GROUP	Referencia Part n°
1	ZAPAP1
2	ZAPAP2
3	ZAPAP3
4	ZAPAP4

NEW

Accesorios para carril

Rail accessories

Accessoires pour rail

Accessori per binario



ROSCA THREAD	DETALLE DESCRIPTION	Referencia Part n°
M6	NUT	TC6I
M8	NUT	TC8I
M10	NUT	TC10I
M12	NUT	TC12I
--	RAIL	TS11I
--	RAIL	TS14I
--	RAIL	TS22I

NEW

NEW

Adaptadores BSP 170

BSP Adaptors
Adapteurs BSP
Adattatori BSP

Adaptadores NPT 180

NPT Adaptors
Adapteurs NPT
Adattatori NPT

Adaptadores O'Ring Boss 185

O'Ring Boss Adaptors
Adapteurs O'Ring Boss
Adattatori O'Ring Boss

Adaptadores ORFS 187

ORFS Adaptors
Adapteurs ORFS
Adattatori ORFS



04

ADAPTADORES

Adaptors

Adapteurs

Adattatori

Adaptadores BSP

BSP Adaptors
Adapteurs BSP
Adattatori BSP

Uniones rectas macho ▪ Straight male adaptors ▪ Unions mâle ▪ Adattatori diritti maschio | 170



Z1010 Z1010_WD Z1011 Z1020 Z1020_WD Z1016 Z1014 Z1024 Z1012 Z1022

Uniones rectas macho-hembra ▪ Adaptors male-female ▪ Unions mâle-femelle ▪ Adattatori diritti maschio-femmina | 172



Z1060 Z1060 Z1061 Z1172 Z1170 Z1173 Z1150

Tapones ▪ Plugs ▪ Bouchons ▪ Tappi | 174



Z1072 Z1070 Z1075

Uniones hembra y pasatabiques ▪ Female adaptors and bulkheads ▪ Unions femelle et passe-cloison ▪ Raccordi femmina e passaparete | 175



Z1310 Z1031 Z1031 Z1160 Z1161

Orientables ▪ Banjos ▪ Adapteurs orientables ▪ Bulloni forati | 176



Z1090 Z1092 Z1140

Juntas metal FKM ▪ Joints ▪ Bague BS ▪ Rondelle Bonded | 176



ZVT210 ZVT320

Codos accesorios ▪ Elbows ▪ Adapteurs coude accessoiriel ▪ Adattatori a 90° e 45° tubolari | 177



Z1194 ZA1196 Z1195 ZA1195

Codos en forja ▪ Forging elbows ▪ Adapteurs coude en forge ▪ Adattatori a 90° e 45° forgiati | 178



Z1190 Z1192 Z1197 Z1191 Z1193 Z1196 Z1198 Z1183

Te y cruces en forja ▪ Forging Tees and croos ▪ Adapteurs Tés en forge et des croix ▪ Adattatori a T forgiati e croce | 179



Z1220 Z1222 Z1224 Z1228 Z1226 Z1221 Z1223 Z1227

Adaptadores NPT

NPT Adaptors
Adapteurs NPT
Adattatori NPT

Uniones rectas macho-macho ▪ Straight male adaptors ▪ Unions mâle ▪ Adattatori diritti maschio - maschio | 180



ZN1015

ZN1015

Uniones rectas macho-hembra ▪ Adaptors male-female ▪ Unions mâle-femelle ▪ Adattatori diritti maschio - femmina | 180



ZN1060

ZN1150

ZN1170

ZN1174

Tapones ▪ Plugs ▪ Bouchons ▪ Tappi | 181



ZN1072

ZN1070

ZN1071

Uniones hembra y pasatabiques ▪ Female adaptors and bulkheads ▪ Unions femelle et passe cloisson ▪ Adattatori femmina e passaparete | 181



ZN1031

Codos en forja ▪ Forging elbows ▪ Adapteurs coude en forge ▪ Adattatori a 90° e 45° forgiati | 182



ZN1190

ZN1193

ZN1196

ZN1198

ZN1396

ZN1393

Tes en forja ▪ Forging tees ▪ Adapteurs Té en forge ▪ Adattatori a T forgiati | 183



ZN1220

ZN1226

CRIMPING FITTINGS
FOR HOSES

PIPE
FITTINGS

PIPE
FITTINGS II

ADAPTORS

WELDING
FITTINGS

INDUSTRIAL
FITTINGS

ACCESSORIES

CONTROL
COMPONENTS

FLOW
MEASURING

TRALE LOK

CRIMPING FITTINGS
FOR HOSES

Adaptadores O'Ring Boss

O'Ring Boss Adaptors
Adapteurs O'Ring Boss
Adattatori O'Ring Boss

PIPE
FITTINGS

Uniones rectas macho ▪ Straight male adaptors ▪ Unions mâle ▪ Unione diritta maschio

| 185



ZS6464

ZS220

ZS3474

ZS6401

PIPE
FITTINGS II

Uniones rectas macho-hembra ▪ Adaptors male-female ▪ Unions mâle-femelle ▪ Unione diritta maschio-femmina

| 185



ZS380

ZS6405

ADAPTORS

Tapones ▪ Plugs ▪ Bouchons ▪ Tappi

| 185



ZS6408

ZS6409

WELDING
FITTINGS

Codos en forja ▪ Forging elbows and tees ▪ Adapteurs coude et té en forge ▪ Curve e T forgiati

| 186



ZS575

INDUSTRIAL
FITTINGS

Tes en forja ▪ Forging Tees ▪ Adapteurs Té en forge ▪ Adattatori a T forgiati

| 186



ZS6803

ZS6804

ACCESSORIES

CONTROL
COMPONENTS

FLOW
MEASURING

TRAILER LOK

Adaptadores ORFS

ORFS Adaptors
Adapteurs ORFS
Adattatori ORFS

Conos y tuercas ORFS ▪ ORFS Nuts and nipples ▪ Écrous et collets ORFS ▪ Dado e Ogive



ZOR102

ZOR1273

Tapones ▪ Plugs ▪ Bouchons ▪ Tappi



ZOR104

ZOR105

Uniones rectas ORFS ▪ ORFS Straight unions ▪ Unions droites ORFS ▪ Adattatori diritti ORFS



ZOR200

ZOR202

ZOR1017

ZOR106

ZOR301

ZOR204

ZOR302

ZOR305

Codos en forja ORFS ▪ ORFS Elbows ▪ Coudes ORFS ▪ Adattatori a 90° ORFS



ZOR405

ZOR600

Tes en forja ORFS ▪ ORFS Tees ▪ Tés ORFS ▪ Adattatori a T ORFS



ZOR700

ZOR701

ZOR702

JVORFS

CRIMPING FITTINGS
FOR HOSES

PIPE
FITTINGS

PIPE
FITTINGS II

ADAPTORS

WELDING
FITTINGS

INDUSTRIAL
FITTINGS

ACCESSORIES

CONTROL
COMPONENTS

FLOW
MEASURING

TRALE LOK

CRIMPING FITTINGS
FOR HOSES

PIPE
FITTINGS

PIPE
FITTINGS II

ADAPTORS

WELDING
FITTINGS

INDUSTRIAL
FITTINGS

ACCESSORIES

CONTROL
COMPONENTS

FLOW
MEASURING

TRALLE LOK

Adaptadores BSP

BSP Adaptors
Adaptateurs BSP
Adattatori BSP

Adaptador macho - macho BSP cono 60º

Adaptor male BSP 60º - male BSP 60º

Adaptateur mâle BSP - mâle BSP cône 60º

Nipples BSP 60º



Reductor macho - macho BSP cono 60º

Reducer male adaptor BSP 60º - male BSP 60º

Réduction mâle BSP - mâle BSP cône 60º

Nipples di riduzione BSP 60º



ROSCA THREAD		Referencia Part nº
1/8" BSP	1/8" BSP	Z101002
1/4" BSP	1/4" BSP	Z101004
1/4" BSP	1/4" BSP	Z101004H19
3/8" BSP	3/8" BSP	Z101006
1/2" BSP	1/2" BSP	Z101008
5/8" BSP	5/8" BSP	Z101010
3/4" BSP	3/4" BSP	Z101012
1" BSP	1" BSP	Z101016
1"1/4 BSP	1"1/4 BSP	Z101020
1"1/2 BSP	1"1/2 BSP	Z101024
2" BSP	2" BSP	Z101032
2" BSP	2" BSP	Z101032H70
2"1/2 BSP	2"1/2 BSP	Z101040
3" BSP	3" BSP	Z101048

ROSCA THREAD		Referencia Part nº
1/8" BSP	1/4" BSP	Z10200204
1/8" BSP	1/4" BSP	Z10200204H19
1/8" BSP	3/8" BSP	Z10200206
1/8" BSP	1/2" BSP	Z10200208
1/4" BSP	3/8" BSP	Z10200406
1/4" BSP	1/2" BSP	Z10200408
1/4" BSP	3/4" BSP	Z10200412
3/8" BSP	1/2" BSP	Z10200608
3/8" BSP	3/4" BSP	Z10200612
3/8" BSP	1" BSP	Z10200616
1/2" BSP	3/4" BSP	Z10200812
1/2" BSP	1" BSP	Z10200816
1/2" BSP	1"1/4 BSP	Z10200820*
1/2" BSP	1"1/2 BSP	Z10200824*
5/8" BSP	1/2" BSP	Z10201008
5/8" BSP	3/4" BSP	Z10201012
3/4" BSP	1" BSP	Z10201216
3/4" BSP	1"1/4 BSP	Z10201220
1" BSP	1"1/4 BSP	Z10201620
1" BSP	1"1/2 BSP	Z10201624
1"1/4 BSP	1"1/2 BSP	Z10202024
1"1/4 BSP	2" BSP	Z10202032
1"1/2 BSP	2" BSP	Z10202432
1"1/2 BSP	2" BSP	Z10202432H70
2" BSP	2"1/2 BSP	Z10203240
2" BSP	3" BSP	Z10203248
2"1/2 BSP	3" BSP	Z10204048

*Hasta fin de existencias / Until end of stock / Jusqu'à la fin du stock / Fino ad esaurimento

Adaptador macho - macho BSP cono 60º con junta encastrada

Adaptor male BSP 60º - male BSP 60º captive seal

Adaptateur mâle BSP - mâle BSP cône 60º avec joint plat

Nipples BSP 60º con guarnizione



ROSCA THREAD		Referencia Part nº
1/4" BSP	1/4" BSP	Z101004WD
3/8" BSP	3/8" BSP	Z101006WD
1/2" BSP	1/2" BSP	Z101008WD
3/4" BSP	3/4" BSP	Z101012WD
1" BSP	1" BSP	Z101016WD

Adaptador macho - macho BSP asiento plano

Adaptor male BSP - male BSP flat seat

Adaptateur mâle BSP - mâle BSP fond plat

Nipples sede piana



ROSCA THREAD		Referencia Part nº
1/4" BSP	1/4" BSP	Z101104
3/8" BSP	3/8" BSP	Z101106
1/2" BSP	1/2" BSP	Z101108
3/4" BSP	3/4" BSP	Z101112
1" BSP	1" BSP	Z101116
1"1/4 BSP	1"1/4 BSP	Z101120
1"1/2 BSP	1"1/2 BSP	Z101124
2" BSP	2" BSP	Z101132

Reductor macho - macho BSP cono 60º con junta encastrada

Reducer male adaptor BSP 60º - male BSP 60º captive seal

Réduction mâle BSP - mâle BSP cône 60º avec joint plat

Nipples di riduzione BSP 60º con guarnizione



ROSCA THREAD		Referencia Part nº
1/4" BSP	3/8" BSP	Z10200406WD
1/4" BSP	1/2" BSP	Z10200408WD
3/8" BSP	1/2" BSP	Z10200608WD
1/2" BSP	3/4" BSP	Z10200812WD
3/4" BSP	1" BSP	Z10201216WD

Adaptadores BSP

BSP Adaptors
Adapteurs BSP
Adattatori BSP

Adaptador macho - macho BSPT

Adaptor male BSPT - male BSPT

Adapteur mâle gaz conique BSPT - mâle gaz conique BSPT

Nipples conico BSPT



ROSCA THREAD		Referencia Part n°
1/4" BSPT	1/8" BSPT	Z10160402
1/4" BSPT	1/4" BSPT	Z10160404
1/4" BSPT	3/8" BSPT	Z10160406
3/8" BSPT	3/8" BSPT	Z10160606
1/2" BSPT	1/2" BSPT	Z10160808
3/4" BSPT	3/4" BSPT	Z10161212
1" BSPT	3/4" BSPT	Z10161612
1" BSPT	1" BSPT	Z10161616
1" 1/4 BSPT	1" 1/4 BSPT	Z10162020
1" 1/2 BSPT	1" 1/2 BSPT	Z10162424
2" BSPT	2" BSPT	Z10163232

Adaptador macho BSP 60° - macho NPT

Adaptor male BSP 60° - male NPT

Adapteur mâle BSP cône 60° - mâle BRIGGS (NPT)

Nipples BSP 60° - NPT 60°



ROSCA THREAD		Referencia Part n°
1/8" BSP	1/8" NPT	Z101402
1/4" BSP	1/4" NPT	Z101404
3/8" BSP	3/8" NPT	Z101406
1/2" BSP	1/2" NPT	Z101408
3/4" BSP	3/4" NPT	Z101412
1" BSP	1" NPT	Z101416
1" 1/4 BSP	1" 1/4 NPT	Z101420
1" 1/2 BSP	1" 1/2 NPT	Z101424
2" BSP	2" NPT	Z101432

Reductor macho BSP 60° - macho NPT

Reducer adaptor male BSP 60° - male NPT

Réduction mâle BSP cône 60° - mâle BRIGGS NPT

Nipples di riduzione BSP 60° - NPT 60°



ROSCA THREAD		Referencia Part n°
1/8" BSP	1/4" NPT	Z10240204
1/4" BSP	1/8" NPT	Z10240402
1/4" BSP	3/8" NPT	Z10240406
1/4" BSP	1/2" NPT	Z10240408
3/8" BSP	1/4" NPT	Z10240604
3/8" BSP	1/2" NPT	Z10240608
3/8" BSP	3/4" NPT	Z10240612
1/2" BSP	3/8" NPT	Z10240806
1/2" BSP	3/4" NPT	Z10240812
5/8" BSP	3/4" NPT	Z10241012
3/4" BSP	1/4" NPT	Z10241204
3/4" BSP	3/8" NPT	Z10241206
3/4" BSP	1/2" NPT	Z10241208
3/4" BSP	1" NPT	Z10241216
3/4" BSP	1" 1/4 NPT	Z10241220
3/4" BSP	1" 1/2 NPT	Z10241224
1" BSP	1/2" NPT	Z10241608
1" BSP	3/4" NPT	Z10241612
1" BSP	1" 1/4 NPT	Z10241620
1" 1/4 BSP	1" NPT	Z10242016
1" 1/4 BSP	1" 1/2 NPT	Z10242024
1" 1/2 BSP	1" 1/4 NPT	Z10242420
1" 1/2 BSP	2" NPT	Z10242432
2" BSP	1" 1/2 NPT	Z10243224

Adaptador macho BSP 60° - macho BSPT

Adaptor male BSP 60° - male BSPT

Adapteur mâle BSP cône 60° - mâle gaz conique BSPT

Niples di congiunzione BSP 60° - BSPT



ROSCA THREAD		Referencia Part n°
1/8" BSP	1/8" BSPT	Z101202
1/4" BSP	1/4" BSPT	Z101204
3/8" BSP	3/8" BSPT	Z101206
1/2" BSP	1/2" BSPT	Z101208
3/4" BSP	3/4" BSPT	Z101212
1" BSP	1" BSPT	Z101216
1" 1/4 BSP	1" 1/4 BSPT	Z101220
1" 1/2 BSP	1" 1/2 BSPT	Z101224
2" BSP	2" BSPT	Z101232

CRIMPING FITTINGS
FOR HOSES

PIPE
FITTINGS

PIPE
FITTINGS II

ADAPTORS

WELDING
FITTINGS

INDUSTRIAL
FITTINGS

ACCESSORIES

CONTROL
COMPONENTS

FLOW
MEASURING

TRALE LOK

CRIMPING FITTINGS
FOR HOSES

PIPE
FITTINGS

PIPE
FITTINGS II

ADAPTORS

WELDING
FITTINGS

INDUSTRIAL
FITTINGS

ACCESSORIES

CONTROL
COMPONENTS

FLOW
MEASURING

TRALLE LOK

Adaptadores BSP

BSP Adaptors
Adapteurs BSP
Adattatori BSP

Reductor macho BSP 60° - macho BSPT

Reducer adaptor male BSP 60° - male BSPT

Réduction mâle BSP cône 60° - mâle gaz conique BSPT

Nipples di riduzione BSP 60° - BSPT



Reductor macho BSP 60° - hembra fija BSP

Reducer adaptor male BSP 60° - fixed female BSP

Prolongateur réducteur mâle BSP cône 60° - femelle gaz

Prolunga di riduzione maschio BSP 60° - femmina BSP



ROSCA THREAD	ROSCA(H) THREAD (F)	Referencia Part n°
1/8" BSP	1/4" BSPT	Z10220204
1/4" BSP	1/8" BSPT	Z10220402
1/4" BSP	3/8" BSPT	Z10220406
1/4" BSP	1/2" BSPT	Z10220408
1/4" BSP	3/4" BSPT	Z10220412
3/8" BSP	1/2" BSPT	Z10220608
3/8" BSP	3/4" BSPT	Z10220612
1/2" BSP	1/4" BSPT	Z10220804
1/2" BSP	3/8" BSPT	Z10220806
1/2" BSP	3/4" BSPT	Z10220812
1/2" BSP	1" BSPT	Z10220816
5/8" BSP	3/4" BSPT	Z10221012
3/4" BSP	1/4" BSPT	Z10221204
3/4" BSP	3/8" BSPT	Z10221206
3/4" BSP	1/2" BSPT	Z10221208
3/4" BSP	1" BSPT	Z10221216
1" BSP	3/4" BSPT	Z10221612
1" BSP	1"1/4 BSPT	Z10221620
1" BSP	2" BSPT	Z10221632
1"1/4 BSP	1" BSPT	Z10222016
1"1/4 BSP	1"1/2 BSPT	Z10222024
1"1/4 BSP	2" BSPT	Z10222032
1 1/2" BSP	1" 1/4 BSPT	Z10222420
1 1/2" BSP	2" BSPT	Z10222432

ROSCA (M) THREAD (M)	ROSCA (H) THREAD (F)	Referencia Part n°
1/8" BSP	1/4" BSP	Z10600204
1/8" BSP	3/8" BSP	Z10600206
1/4" BSP	1/8" BSP	Z10600402
1/4" BSP	3/8" BSP	Z10600406
1/4" BSP	1/2" BSP	Z10600408
3/8" BSP	1/4" BSP	Z10600604
3/8" BSP	1/2" BSP	Z10600608
1/2" BSP	1/4" BSP	Z10600804
1/2" BSP	3/8" BSP	Z10600806
1/2" BSP	3/4" BSP	Z10600812
1/2" BSP	1" BSP	Z10600816
3/4" BSP	3/8" BSP	Z10601206
3/4" BSP	1/2" BSP	Z10601208
3/4" BSP	1" BSP	Z10601216
1" BSP	3/4" BSP	Z10601612
1" BSP	1"1/4 BSP	Z10601620
1" BSP	1"1/2 BSP	Z10601624
1"1/4 BSP	1" BSP	Z10602016
1"1/2 BSP	1"1/4 BSP	Z10602420
1"1/2 BSP	2" BSP	Z10602432
2" BSP	1"1/2 BSP	Z10603224

Prolongador macho BSP 60° - hembra fija BSP

Adaptor male BSP 60° - fixed female BSP

Prolongateur mâle BSP cône 60° - femelle gaz fixe

Prolunga maschio BSP 60° - femmina BSP



Prolongador macho BSPT - hembra fija BSP

Adaptor male BSPT - fixed female BSP

Prolongateur mâle BSPT - femelle gaz fixe

Prolunga maschio BSPT - femmina BSP



ROSCA(M) THREAD (M)	ROSCA(H) THREAD (F)	Referencia Part n°
1/8" BSP	1/8" BSP	Z1060002
1/4" BSP	1/4" BSP	Z1060004
3/8" BSP	3/8" BSP	Z1060006
1/2" BSP	1/2" BSP	Z1060008
3/4" BSP	3/4" BSP	Z1060012
1" BSP	1" BSP	Z1060016
1"1/4 BSP	1"1/4 BSP	Z1060020
1"1/2 BSP	1"1/2 BSP	Z1060024
2" BSP	2" BSP	Z1060032

ROSCA THREAD	ROSCA(H) THREAD (F)	Referencia Part n°
1/4" BSPT	1/4" BSP	Z106104
3/8" BSPT	3/8" BSP	Z106106
1/2" BSPT	1/2" BSP	Z106108
3/4" BSPT	3/4" BSP	Z106112
1" BSPT	1" BSP	Z106116

Adaptadores BSP

BSP Adaptors
Adaptateurs BSP
Adattatori BSP

Adaptador hembra giratoria - hembra giratoria BSP 60º

Adaptor BSP 60º swivel female - BSP 60º swivel female

Adaptateur femelle tournante BSP 60º - femelle tournante BSP 60º

Nipples femmina - femmina girevole BSP 60º

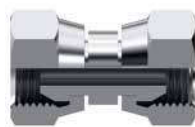

ROSCA THREAD	ROSCA THREAD	Referencia Part nº
1/4" BSP	1/4" BSP	Z117204
3/8" BSP	3/8" BSP	Z117206
1/2" BSP	1/2" BSP	Z117208
3/4" BSP	3/4" BSP	Z117212
1" BSP	1" BSP	Z117216
1" 1/4 BSP	1" 1/4 BSP	Z117220
1" 1/2 BSP	1" 1/2 BSP	Z117224
2" BSP	2" BSP	Z117232

Adaptador macho - hembra giratoria BSP cono 60º

Adaptor male BSP 60º - swivel female BSP 60º

Adaptateur mâle BSP - femelle tournante BSP cône 60º

Nipples maschio - femmina girevole BSP 60º



ROSCA (M) THREAD (M)	ROSCA (H) THREAD (F)	Referencia Part nº
1/8" BSP	1/8" BSP	Z117002
1/4" BSP	1/4" BSP	Z117004
1/4" BSP	1/4" BSP	Z117004H19
3/8" BSP	3/8" BSP	Z117006
1/2" BSP	1/2" BSP	Z117008
3/4" BSP	3/4" BSP	Z117012
1" BSP	1" BSP	Z117016
1" 1/4 BSP	1" 1/4 BSP	Z117020
1" 1/2 BSP	1" 1/2 BSP	Z117024
2" BSP	2" BSP	Z117032

Reductor macho - hembra giratoria BSP cono 60º

Reducer male BSP 60º - swivel female BSP 60º

Réduction mâle BSP - femelle tournante BSP cône 60º

Nipples di riduzione maschio - femmina girevole BSP 60º



ROSCA (M) THREAD (M)	ROSCA (H) THREAD (F)	Referencia Part nº
1/8" BSP	1/4" BSP	Z11730204
1/4" BSP	1/8" BSP	Z11730402
1/4" BSP	3/8" BSP	Z11730406
3/8" BSP	1/4" BSP	Z11730604
3/8" BSP	1/2" BSP	Z11730608
1/2" BSP	3/8" BSP	Z11730806
1/2" BSP	3/4" BSP	Z11730812
3/4" BSP	1/2" BSP	Z11731208
3/4" BSP	1" BSP	Z11731216
1" BSP	3/4" BSP	Z11731612
1" BSP	1" 1/4 BSP	Z11731620
1" 1/4 BSP	1" BSP	Z11732016
1" 1/4 BSP	1" 1/2 BSP	Z11732024
1" 1/2 BSP	1" 1/4 BSP	Z11732420
1" 1/2 BSP	2" BSP	Z11732432
2" BSP	1" 1/2 BSP	Z11733224

CRIMPING FITTINGS
FOR HOSES

PIPE
FITTINGS

PIPE
FITTINGS II

ADAPTORS

WELDING
FITTINGS

INDUSTRIAL
FITTINGS

ACCESSORIES

CONTROL
COMPONENTS

FLOW
MEASURING

TRALE LOK

Adaptadores BSP

BSP Adaptors
Adapteurs BSP
Adattatori BSP

Tapón reductor macho BSP 60° - hembra fija BSP

Reducer plug male BSP 60° - fixed female BSP

Bouchon réducteur mâle BSP cône 60° - femelle gaz

Tappo di riduzione maschio BSP 60° - femmina BSP



ROSCA (M) THREAD (M)	ROSCA (H) THREAD (F)	Referencia Part n°
1/4" BSP	1/8" BSP	Z11500402
3/8" BSP	1/8" BSP	Z11500602
3/8" BSP	1/4" BSP	Z11500604
1/2" BSP	1/4" BSP	Z11500804
1/2" BSP	3/8" BSP	Z11500806
3/4" BSP	1/2" BSP	Z11501208
1" BSP	1/2" BSP	Z11501608
1" BSP	3/4" BSP	Z11501612
1" 1/4 BSP	3/4" BSP	Z11502012
1" 1/4 BSP	1" BSP	Z11502016
1" 1/2 BSP	1" BSP	Z11502416
2" BSP	1" BSP	Z11503216
2" BSP	1" 1/2 BSP	Z11503224

Tapón hembra hexagonal rosca BSP

BSP fixed female plug

Bouchon femelle gaz

Tappo femmina fissa BSP



ROSCA THREAD	Referencia Part n°
1/4" BSP	Z107204
3/8" BSP	Z107206
1/2" BSP	Z107208
3/4" BSP	Z107212
1" BSP	Z107216
1" 1/4 BSP	Z107220
1" 1/2 BSP	Z107224
2" BSP	Z107232

Tapón macho hexagonal rosca BSP 60°

BSP male hexagonal plug

Bouchon mâle BSP cône 60°

Tappo maschio esagonale BSP 60°



ROSCA THREAD	Referencia Part n°
1/8" BSP	Z107002
1/4" BSP	Z107004
3/8" BSP	Z107006
1/2" BSP	Z107008
3/4" BSP	Z107012
1" BSP	Z107016
1" 1/4 BSP	Z107020
1" 1/2 BSP	Z107024
2" BSP	Z107032

Tapón hembra giratoria BSP cono 60°

BSP swivel female plug

Bouchon femelle tournante BSP cône 60°

Tappo femmina girevole BSP 60°



ROSCA THREAD	Referencia Part n°
1/4" BSP	Z107504
3/8" BSP	Z107506
1/2" BSP	Z107508
3/4" BSP	Z107512
1" BSP	Z107516
1" 1/4 BSP	Z107520
1" 1/2 BSP	Z107524
2" BSP	Z107532

Adaptadores BSP

BSP Adaptors
Adaptateurs BSP
Adattatori BSP

Manguito redondo roscado hembra BSP

Adaptor female fixed BSP - female fixed BSP

Manchon femelle gaz ronde

Manicotto femmina - femmina BSP



ROSCA THREAD	Referencia Part n°
1/8" BSP	Z131002
1/4" BSP	Z131004
3/8" BSP	Z131006
1/2" BSP	Z131008
5/8" BSP	Z131010
3/4" BSP	Z131012
1" BSP	Z131016
1"1/4 BSP	Z131020
1"1/2 BSP	Z131024
2" BSP	Z131032

Manguito hexagonal roscado hembra BSP

Adaptor hexagonal female fixed BSP - female fixed BSP

Manchon femelle gaz - femelle gaz hexagone

Prolunga esagonale femmina - femmina BSP



ROSCA THREAD	Referencia Part n°
1/4" BSP	Z103104
3/8" BSP	Z103106
1/2" BSP	Z103108
3/4" BSP	Z103112
1" BSP	Z103116
1"1/4 BSP	Z103120
1"1/2 BSP	Z103124

Manguito reducción hexagonal roscado hembra BSP

Reducer hexagonal female fixed BSP - female fixed BSP

Manchon réducteur femelle gaz - femelle gaz hexagone

Riduzione femmina - femmina BSP



ROSCA THREAD	Referencia Part n°
3/8" BSP	1/4" BSP Z10310604
1/2" BSP	1/4" BSP Z10310804
1/2" BSP	3/8" BSP Z10310806
3/4" BSP	1/2" BSP Z10311208
1" BSP	3/4" BSP Z10311612
1"1/4 BSP	1" BSP NEW Z10312016

Pasatabiques sin tuerca BSP cono 60°

Straight bulkhead adaptor BSP 60° without nut

Passe-cloison mâle BSP 60° - mâle BSP 60° sans équiper

Nipples passaparete BSP 60° (senza controdado)



ROSCA THREAD	Referencia Part n°
1/4" BSP	Z116004
3/8" BSP	Z116006
1/2" BSP	Z116008
3/4" BSP	Z116012
1" BSP	Z116016
1" 1/4 BSP	Z116020
1" 1/2 BSP	Z116024
2" BSP	Z116032

Tuerca pasatabiques BSP

Conter nut for BSP bulkhead

Contre-écrou passe-cloison gaz

Controdado per passaparete



ROSCA THREAD	Referencia Part n°
1/4" BSP	Z116104
3/8" BSP	Z116106
1/2" BSP	Z116108
3/4" BSP	Z116112
1" BSP	Z116116
1" 1/4 BSP	Z116120
1" 1/2 BSP	Z116124
2" BSP	Z116132

CRIMPING FITTINGS
FOR HOSES

PIPE
FITTINGS

PIPE
FITTINGS II

ADAPTORS

WELDING
FITTINGS

INDUSTRIAL
FITTINGS

ACCESSORIES

CONTROL
COMPONENTS

FLOW
MEASURING

TRALE LOK

CRIMPING FITTINGS
FOR HOSES

PIPE
FITTINGS

PIPE
FITTINGS II

ADAPTORS

WELDING
FITTINGS

INDUSTRIAL
FITTINGS

ACCESSORIES

CONTROL
COMPONENTS

FLOW
MEASURING

TRAILER LOK

Adaptadores BSP

BSP Adaptors
Adapteurs BSP
Adattatori BSP

Tornillo orientable simple BSP

BSP Bolt for banjo

Vis creuse simple pour banjo BSP

Bullone forato BSP



ROSCA THREAD	Referencia Part n°
1/8" BSP	Z109002
1/4" BSP	Z109004
3/8" BSP	Z109006
1/2" BSP	Z109008
3/4" BSP	Z109012
1" BSP	Z109016

Tornillo orientable simple Métrico

Metric bolt for banjo

Vis creuse simple for banjo Métrique

Bullone forato Metrico



ROSCA THREAD	Referencia Part n°
M12X1.5	Z109212
M14X1.5	Z109214
M16X1.5	Z109216
M18X1.5	Z109218
M22X1.5	Z109222
M26X1.5	Z109226
M30X2	Z109230

Esférico BSP - macho BSP (60°)

BSP Banjo-BSP male (60°)

Banjo passage gaz x mâle BSP (60°)

Adattatore ad occhio filettato BSP 60°



ROSCA THREAD	Ø	Referencia Part n°
1/4" BSP	1/4"	Z114004
3/8" BSP	3/8"	Z114006
1/2" BSP	1/2"	Z114008
3/4" BSP	3/4"	Z114012
1" BSP	1"	Z114016

Juntas metal FKM Gas Autocentrantes

BSP Bonded Seal FKM Self-centering

Bague BS gaz FKM auto-centrée

Rondella Bonded BSP Autocentrante (INOX-FKM)



ROSCA THREAD	Referencia Part n°
1/8" BSP	ZVT21002
1/4" BSP	ZVT21004
3/8" BSP	ZVT21006
1/2" BSP	ZVT21008
5/8" BSP	ZVT21010
3/4" BSP	ZVT21012
1" BSP	ZVT21016
1" 1/4 BSP	ZVT21020
1" 1/2 BSP	ZVT21024
2" BSP	ZVT21032
2" 1/2 BSP	ZVT21040

Juntas metal FKM Métricas Autocentrantes

Metric Bonded Seal in FKM Self-centering

Bague BS Métrique FKM auto-centrée

Rondella Bonded metrica Autocentrante (INOX-FKM)



ROSCA THREAD	Referencia Part n°
M6X1	ZVT32006
M8X1	ZVT32008
M10X1	ZVT32010
M12X1,5	ZVT32012
M14X1,5	ZVT32014
M16X1,5	ZVT32016
M18X1,5	ZVT32018
M20X1,5	ZVT32020
M22X1,5	ZVT32022
M24X1.5	ZVT32024
M26X1.5	ZVT32026
M27X1,5	ZVT32027
M30X2	ZVT32030
M36X2	ZVT32036
M42X2	ZVT32042
M48X2	ZVT32048

Adaptadores BSP

BSP Adaptors
Adapteurs BSP
Adattatori BSP

Codo 90° macho - hembra giratoria BSP cono 60°

90° Elbow swivel female BSP 60° - male BSP 60°

Adapteur coude 90° accessoiriel mâle BSP - femelle tournante BSP cône 60°

Curva 90° maschio - femmina girevole BSP 60°



ROSCA THREAD		Referencia Part n°
1/4" BSP	1/4" BSP	Z119404
3/8" BSP	3/8" BSP	Z119406
1/2" BSP	1/2" BSP	Z119408
3/4" BSP	3/4" BSP	Z119412
1" BSP	1" BSP	Z119416
1"1/4 BSP	1"1/4 BSP	Z119420
1"1/2 BSP	1"1/2 BSP	Z119424
2" BSP	2" BSP	Z119432

Codo 90° hembra giratoria - hembra giratoria BSP co

90° Elbow swivel female BSP 60° - swivel female BSP 60°

Adapteur coude 90° femelle tournante BSP - femelle tournante cône 60°

Curva 90° femmina - femmina girevole BSP 60°



ROSCA THREAD		Referencia Part n°
1/4" BSP	1/4" BSP	ZA119604
3/8" BSP	3/8" BSP	ZA119606
1/2" BSP	1/2" BSP	ZA119608
3/4" BSP	3/4" BSP	ZA119612
1" BSP	1" BSP	ZA119616
1"1/4 BSP	1"1/4 BSP	ZA119620

Codo 45° macho - hembra giratoria BSP cono 60°

45° Ebow swivel female BSP 60° - male BSP 60°

Adapteur coude 45° accessoiriel mâle BSP - femelle tournante BSP cône 60°

Curva 45° maschio - femmina girevole BSP 60°



ROSCA THREAD		Referencia Part n°
1/4" BSP	1/4" BSP	Z119504
3/8" BSP	3/8" BSP	Z119506
1/2" BSP	1/2" BSP	Z119508
3/4" BSP	3/4" BSP	Z119512
1" BSP	1" BSP	Z119516
1"1/4 BSP	1"1/4 BSP	Z119520
1"1/2 BSP	1"1/2 BSP	Z119524
2" BSP	2" BSP	Z119532

Codo 45° hembra giratoria - hembra giratoria BSP cono

45° Ebow swivel female BSP 60° - swivel female BSP 60°

Adapteur coude 45° femelle tournante BSP - femelle tournante BSP cône 60°

Curva 45° femmina girevole - femmina girevole BSP 60°



ROSCA THREAD		Referencia Part n°
1/4" BSP	1/4" BSP	ZA119504
3/8" BSP	3/8" BSP	ZA119506
1/2" BSP	1/2" BSP	ZA119508
3/4" BSP	3/4" BSP	ZA119512
1" BSP	1" BSP	ZA119516
1"1/4 BSP	1"1/4 BSP	ZA119520

CRIMPING FITTINGS
FOR HOSES

PIPE
FITTINGS

PIPE
FITTINGS II

ADAPTORS

WELDING
FITTINGS

INDUSTRIAL
FITTINGS

ACCESSORIES

CONTROL
COMPONENTS

FLOW
MEASURING

TRALE LOK

Adaptadores BSP

BSP Adaptors
Adaptateurs BSP
Adattatori BSP

CRIMPING FITTINGS
FOR HOSES

PIPE
FITTINGS

Codo 90° macho - macho BSP cono 60°

90° Adaptor male - male BSP 60°

Adaptateur coude 90° mâle BSP - mâle BSP cône 60° forge

Adattatore a 90° maschio - maschio BSP 60°



ROSCA THREAD		Referencia Part n°
1/8" BSP	1/8" BSP	Z1190002
1/4" BSP	1/4" BSP	Z1190004
3/8" BSP	3/8" BSP	Z1190006
1/2" BSP	1/2" BSP	Z1190008
3/4" BSP	3/4" BSP	Z1190012
1" BSP	1" BSP	Z1190016
1"1/4 BSP	1"1/4 BSP	Z1190020
1"1/2 BSP	1"1/2 BSP	Z1190024

PIPE
FITTINGS II

ADAPTORS

Codo 90° macho - hembra giratoria BSP cono 60°

90° Adaptor male - swivel female BSP 60°

Adaptateur coude 90° mâle BSP - femelle tournante BSP cône 60° forge

Adattatore a 90° maschio - femmina girevole BSP 60°



ROSCA THREAD		Referencia Part n°
1/8" BSP	1/8" BSP	Z119302
1/4" BSP	1/4" BSP	Z119304
3/8" BSP	3/8" BSP	Z119306
1/2" BSP	1/2" BSP	Z119308
3/4" BSP	3/4" BSP	Z119312
1" BSP	1" BSP	Z119316
1"1/4 BSP	1"1/4 BSP	Z119320
1"1/2 BSP	1"1/2 BSP	Z119324

WELDING
FITTINGS

Codo 90° macho BSP 60° - macho BSPT

90° Adaptor male BSP 60° - male BSPT

Adaptateur coude 90° mâle BSP cône 60° - mâle gaz conique BSPT forge

Adattatore a 90° maschio BSP 60° - maschio BSPT



ROSCA THREAD		Referencia Part n°
1/8" BSP	1/8" BSPT	Z119202
1/4" BSP	1/4" BSPT	Z119204
3/8" BSP	3/8" BSPT	Z119206
1/2" BSP	1/2" BSPT	Z119208
3/4" BSP	3/4" BSPT	Z119212
1" BSP	1" BSPT	Z119216
1"1/4 BSP	1"1/4 BSPT	Z119220
1"1/2 BSP	1"1/2 BSPT	Z119224

INDUSTRIAL
FITTINGS

Codo 90° hembra fija - hembra fija BSP

90° Adaptor fixed female BSP

Adaptateur coude 90° femelle fixe gaz cylindrique forge

Adattatore a 90° femmina fissa BSP



ROSCA THREAD		Referencia Part n°
1/8" BSP	1/8" BSP	Z119602
1/4" BSP	1/4" BSP	Z119604
3/8" BSP	3/8" BSP	Z119606
1/2" BSP	1/2" BSP	Z119608
3/4" BSP	3/4" BSP	Z119612
1" BSP	1" BSP	Z119616

ACCESSORIES

Codo 90° regulable macho - macho BSP

90° Adjustable stud elbow male-male BSP

Coude 90° orientable mâle - mâle BSP

Adattatore a 90° orientabile maschio - maschio BSP



ROSCA THREAD		Referencia Part n°
1/4" BSP	1/4" BSP	Z119704
3/8" BSP	3/8" BSP	Z119706
1/2" BSP	1/2" BSP	Z119708
3/4" BSP	3/4" BSP	Z119712
1" BSP	1" BSP	Z119716

CONTROL
COMPONENTS

Codo 90° hembra giratoria - hembra giratoria BSP con

90° Adaptor swivel female BSP 60°

Adaptateur coude 90° femelle tournante BSP cône 60° forge

Adattatore a 90° femmina girevole BSP 60°



ROSCA THREAD		Referencia Part n°
1/4" BSP	1/4" BSP	Z119804
3/8" BSP	3/8" BSP	Z119806
1/2" BSP	1/2" BSP	Z119808
3/4" BSP	3/4" BSP	Z119812
1" BSP	1" BSP	Z119816
1"1/4 BSP	1"1/4 BSP	Z119820
1"1/2 BSP	1"1/2 BSP	Z119824

FLOW
MEASURING

Codo 90° macho BSP 60° - macho NPT

90° Adaptor male BSP 60° - male NPT

Adaptateur coude 90° mâle BSP 60° - mâle NPT forge

Adattatore a 90° maschio BSP 60° - maschio NPT 60°



ROSCA THREAD		Referencia Part n°
1/4" BSP	1/4" NPT	Z11910404
3/8" BSP	3/8" NPT	Z11910606
1/2" BSP	1/2" NPT	Z11910808
3/4" BSP	3/4" NPT	Z11911212
1" BSP	1" NPT	Z11911616

Codo 45° macho - hembra giratoria BSP cono 60°

45° Adaptor male - swivel female BSP 60°

Adaptateur coude 45° mâle BSP - femelle tournante BSP cône 60° forge

Adattatore a 45° maschio - femmina girevole BSP 60°



ROSCA THREAD		Referencia Part n°
1/4" BSP	1/4" BSP	Z118304
3/8" BSP	3/8" BSP	Z118306
1/2" BSP	1/2" BSP	Z118308
3/4" BSP	3/4" BSP	Z118312
1" BSP	1" BSP	Z118316

TRALLE LOK

Adaptadores BSP

BSP Adaptors
Adapteurs BSP
Adattatori BSP

Tes macho - macho - macho BSP cono 60°

Tees BSP 60° male

Adapteurs Té mâle BSP cône 60° forge

Adattatore a T maschio BSP 60°



ROSCA THREAD			Referencia Part n°
1/4" BSP	1/4" BSP	1/4" BSP	Z122004
3/8" BSP	3/8" BSP	3/8" BSP	Z122006
1/2" BSP	1/2" BSP	1/2" BSP	Z122008
3/4" BSP	3/4" BSP	3/4" BSP	Z122012
1" BSP	1" BSP	1" BSP	Z122016
1"1/4 BSP	1"1/4 BSP	1"1/4 BSP	Z122020
1"1/2 BSP	1"1/2 BSP	1"1/2 BSP	Z122024

Tes macho - macho - hembra giratoria BSP 60°

Tees BSP 60° male - male - swivel female

Adapteurs Té mâle BSP - mâle BSP - femelle tournante BSP cône 60° forge

Adattatore a T maschio - maschio - femmina girevole BSP 60°



ROSCA (M) THREAD (M)	ROSCA (H) THREAD (F)	Referencia Part n°
1/4" BSP	1/4" BSP	Z122204
3/8" BSP	3/8" BSP	Z122206
1/2" BSP	1/2" BSP	Z122208
3/4" BSP	3/4" BSP	Z122212
1" BSP	1" BSP	Z122216
1"1/4 BSP	1"1/4 BSP	Z122220
1"1/2 BSP	1"1/2 BSP	Z122224

Tes macho - hembra giratoria - macho BSP 60°

Tees BSP 60° male - swivel female - male

Adapteurs Té mâle BSP - femelle tournante - mâle BSP cône 60° forge

Adattatore a T maschio - femmina girevole - maschio BSP 60°



ROSCA (M) THREAD (M)	ROSCA (H) THREAD (F)	ROSCA (M) THREAD (M)	Referencia Part n°
1/4" BSP	1/4" BSP	1/4" BSP	Z122404
3/8" BSP	3/8" BSP	3/8" BSP	Z122406
1/2" BSP	1/2" BSP	1/2" BSP	Z122408
3/4" BSP	3/4" BSP	3/4" BSP	Z122412
1" BSP	1" BSP	1" BSP	Z122416
1"1/4 BSP	1"1/4 BSP	1"1/4 BSP	Z122420
1"1/2 BSP	1"1/2 BSP	1"1/2 BSP	Z122424

Tes hembras giratorias BSP cono 60°

Tees BSP 60° swivel female

Adapteurs Té femelle tournante BSP cône 60° forge

Adattatore a T femmina girevole BSP 60°



ROSCA THREAD			Referencia Part n°
1/4" BSP	1/4" BSP	1/4" BSP	Z122804
3/8" BSP	3/8" BSP	3/8" BSP	Z122806
1/2" BSP	1/2" BSP	1/2" BSP	Z122808
3/4" BSP	3/4" BSP	3/4" BSP	Z122812
1" BSP	1" BSP	1" BSP	Z122816
1"1/4 BSP	1"1/4 BSP	1"1/4 BSP	Z122820
1"1/2 BSP	1"1/2 BSP	1"1/2 BSP	Z122824

Tes hembras fijas BSP

Tees fixed female BSP

Adapteurs Té femelle gaz forge

Adattatore a T femmina fissa BSP



ROSCA THREAD			Referencia Part n°
1/4" BSP	1/4" BSP	1/4" BSP	Z122604
3/8" BSP	3/8" BSP	3/8" BSP	Z122606
1/2" BSP	1/2" BSP	1/2" BSP	Z122608
3/4" BSP	3/4" BSP	3/4" BSP	Z122612
1" BSP	1" BSP	1" BSP	Z122616

Tes macho BSP 60° - macho NPT central - macho BSP

Tees BSP 60° male - NPT male center - BSP 60° male

Adapteurs Té mâle BSP 60° - mâle NPT central - mâle BSP 60° forge

Adattatore a T maschio BSP 60° - maschio NPT 60° centrale - maschio BSP 60°



ROSCA THREAD			Referencia Part n°
1/4" BSP	1/4" NPT	1/4" BSP	Z12210404
3/8" BSP	3/8" NPT	3/8" BSP	Z12210606
1/2" BSP	1/2" NPT	1/2" BSP	Z12210808
3/4" BSP	3/4" NPT	3/4" BSP	Z12211212
1" BSP	1" NPT	1" BSP	Z12211616

Tes macho BSP 60° - macho BSP 60° - macho NPT la

Tees BSP 60° male - BSP 60° male - NPT lateral male

Adapteurs Té mâle BSP 60° - mâle BSP 60° - mâle NPT latéral forge

Adattatore a T maschio BSP 60° - maschio BSP 60° - maschio NPT 60° laterale



ROSCA THREAD			Referencia Part n°
1/4" BSP	1/4" BSP	1/4" NPT	Z12230404
3/8" BSP	3/8" BSP	3/8" NPT	Z12230606
1/2" BSP	1/2" BSP	1/2" NPT	Z12230808
3/4" BSP	3/4" BSP	3/4" NPT	Z12231212
1" BSP	1" BSP	1" NPT	Z12231616

Cruz hembra fija BSP

Cross fixed female BSP

Croix BSP femelle fixe

Adattatore a croce femmina fissa BSP



ROSCA THREAD	Referencia Part n°
1/4" BSP	Z122704
3/8" BSP	Z122706
1/2" BSP	Z122708
3/4" BSP	Z122712
1" BSP	Z122716

CRIMPING FITTINGS
FOR HOSES

PIPE
FITTINGS

PIPE
FITTINGS II

ADAPTORS

WELDING
FITTINGS

INDUSTRIAL
FITTINGS

ACCESSORIES

CONTROL
COMPONENTS

FLOW
MEASURING

TRALLE LOK

Adaptadores NPT

NPT Adaptors
Adaptateurs NPT
Adattatori NPT

Adaptor macho - macho NPT

Adaptor male NPT - male NPT

Adaptateur mâle NPT - mâle NPT

Niples di congiunzione NPT



ROSCA THREAD	ROSCA THREAD	Referencia Part n°
1/4" NPT	1/4" NPT	Z10150404
3/8" NPT	3/8" NPT	Z10150606
1/2" NPT	1/2" NPT	Z10150808
3/4" NPT	3/4" NPT	Z10151212
1" NPT	1" NPT	Z10151616
1" 1/4 NPT	1" 1/4 NPT	Z10152020
1" 1/2 NPT	1" 1/2 NPT	Z10152424
2" NPT	2" NPT	Z10153232

Reductor macho - macho NPT

Reducer male NPT - male NPT

Réducteur mâle NPT- mâle NPT

Niples di riduzione maschio - maschio NPT



ROSCA THREAD	ROSCA THREAD	Referencia Part n°
1/4" NPT	1/8" NPT	ZN10150402
3/8" NPT	1/8" NPT	ZN10150602
3/8" NPT	1/4" NPT	ZN10150604
1/2" NPT	1/4" NPT	ZN10150804
1/2" NPT	3/8" NPT	ZN10150806
3/4" NPT	3/8" NPT	ZN10151206
3/4" NPT	1/2" NPT	ZN10151208
1" NPT	1/2" NPT	ZN10151608
1" NPT	3/4" NPT	ZN10151612
1" 1/4 NPT	1" NPT	ZN10152016
1" 1/2 NPT	1" NPT	ZN10152416
1" 1/2 NPT	1" 1/4 NPT	ZN10152420

Adaptador macho - hembra fija NPT

Adaptor male NPT - fixed female NPT

Adaptateur mâle NPT - femelle fixe NPT

Niples di congiunzione maschio NPT - femmina fissa NPT



ROSCA (M) THREAD (M)	ROSCA (H) THREAD (F)	Referencia Part n°
1/8" NPT	1/8" NPT	ZN10600202
1/8" NPT	1/4" NPT	ZN10600204
1/4" NPT	1/8" NPT	ZN10600402
1/4" NPT	1/4" NPT	ZN10600404
1/4" NPT	3/8" NPT	ZN10600406
1/4" NPT	1/2" NPT	ZN10600408
3/8" NPT	1/4" NPT	ZN10600604
3/8" NPT	3/8" NPT	ZN10600606
3/8" NPT	1/2" NPT	ZN10600608
1/2" NPT	3/8" NPT	ZN10600806
1/2" NPT	1/2" NPT	ZN10600808
1/2" NPT	3/4" NPT	ZN10600812
3/4" NPT	1/2" NPT	ZN10601208
3/4" NPT	3/4" NPT	ZN10601212
3/4" NPT	1" NPT	ZN10601216
1" NPT	3/4" NPT	ZN10601612
1" NPT	1" NPT	ZN10601616

Reductor macho - hembra fija NPT

Reducer male NPT - fixed female NPT

Réducteur mâle NPT - femelle fixe NPT

Niples di riduzione maschio NPT - femmina fissa NPT



ROSCA (M) THREAD (M)	ROSCA (H) THREAD (F)	Referencia Part n°
3/8" NPT	1/8" NPT	ZN11500602
3/8" NPT	1/4" NPT	ZN11500604
1/2" NPT	1/4" NPT	ZN11500804
1/2" NPT	3/8" NPT	ZN11500806
3/4" NPT	1/4" NPT	ZN11501204
3/4" NPT	3/8" NPT	ZN11501206
3/4" NPT	1/2" NPT	ZN11501208
1" NPT	3/8" NPT	ZN11501606
1" NPT	1/2" NPT	ZN11501608
1" NPT	3/4" NPT	ZN11501612
1" 1/4 NPT	1" NPT	ZN11502016
1" 1/2 NPT	1" NPT	ZN11502416
1" 1/2 NPT	1" 1/4 NPT	ZN11502420

Adaptador macho NPT - hembra giratoria NPSM

Adaptor male NPT - swivel female NPSM

Adaptateur mâle NPT - femelle tournante NPSM

Niples di congiunzione maschio NPT - femmina girevole NPSM



ROSCA (M) THREAD (M)	ROSCA (H) THREAD (F)	Referencia Part n°
1/8" NPT	1/8" NPSM	ZN11700202
1/4" NPT	1/4" NPSM	ZN11700404
3/8" NPT	3/8" NPSM	ZN11700606
3/8" NPT	1/2" NPSM	ZN11700608
1/2" NPT	1/2" NPSM	ZN11700808
1/2" NPT	3/4" NPSM	ZN11700812
3/4" NPT	3/4" NPSM	ZN11701212
3/4" NPT	1" NPSM	ZN11701216
1" NPT	1" NPSM	ZN11701616
1" 1/4 NPT	1" 1/4 NPSM	ZN11702020
1" 1/2 NPT	1" 1/2 NPSM	ZN11702424

Adaptador macho UNF - hembra giratoria NPSM

Adaptor male UNF - swivel female NPSM

Adaptateur mâle UNF - femelle tournante NPSM

Niples di giunzione maschio UNF - femmina girevole NPSM



ROSCA THREAD	ROSCA THREAD	Referencia Part n°
7/16" 20h UNF	1/4" 18h NPSM	ZN11740404
9/16" 18h UNF	3/8" 18h NPSM	ZN11740606
9/16" 18h UNF	1/2" 14h NPSM	ZN11740608
3/4" 16h UNF	1/2" 14h NPSM	ZN11740808
3/4" 16h UNF	3/4" 14h NPSM	ZN11740812
7/8" 14h UNF	1/2" 14h NPSM	ZN11741008
7/8" 14h UNF	3/4" 14h NPSM	ZN11741012
1" 1/16 12h UNF	3/4" 14h NPSM	ZN11741212
1" 5/16 12h UNF	1" 11 1/2h NPSM	ZN11741616
1" 5/8 12h UNF	1" 1/4 11-1/2h NPSM	ZN11742020

Adaptadores NPT

NPT Adaptors
Adapteurs NPT
Adattatori NPT

Tapón hembra fija NPT

S.S. NPT fixed cap

Bouchon femelle fixe NPT

Tappo femmina fissa NPT



ROSCA THREAD	Referencia Part n°
1/8" NPT	ZN107202
1/4" NPT	ZN107204
3/8" NPT	ZN107206
1/2" NPT	ZN107208
3/4" NPT	ZN107212
1" NPT	ZN107216

Tapón macho NPT

S.S. NPT male plug

Bouchon mâle NPT

Tappo maschio NPT



ROSCA THREAD	Referencia Part n°
1/8" NPT	ZN107002
1/4" NPT	ZN107004
3/8" NPT	ZN107006
1/2" NPT	ZN107008
3/4" NPT	ZN107012
1" NPT	ZN107016
1"1/4 NPT	ZN107020
1"1/2 NPT	ZN107024

Tapón Allen NPT

S.S. NPT Allen plug

Bouchon Allen NPT

Tappo conico NPT con esagono incassato



ROSCA THREAD	Referencia Part n°
1/4" NPT	ZN107104
3/8" NPT	ZN107106
1/2" NPT	ZN107108
3/4" NPT	ZN107112
1" NPT	ZN107116

Adaptador hexagonal hembra fija NPT

NPT hexagonal adaptor fixed female

Adapteur hexagonal femelle fixe NPT

Adattatore esagonale femmina fissa NPT



ROSCA THREAD	Referencia Part n°
1/8" NPT	1/8" NPT ZN10310202
1/4" NPT	1/4" NPT ZN10310404
3/8" NPT	3/8" NPT ZN10310606
1/2" NPT	1/2" NPT ZN10310808
3/4" NPT	3/4" NPT ZN10311212
1" NPT	1" NPT ZN10311616
1" 1/4 NPT	1" 1/4 NPT ZN10312020

CRIMPING FITTINGS
FOR HOSES

PIPE
FITTINGS

PIPE
FITTINGS II

ADAPTORS

WELDING
FITTINGS

INDUSTRIAL
FITTINGS

ACCESSORIES

CONTROL
COMPONENTS

FLOW
MEASURING

TRALE LOK

CRIMPING FITTINGS
FOR HOSES

PIPE
FITTINGS

PIPE
FITTINGS II

ADAPTORS

WELDING
FITTINGS

INDUSTRIAL
FITTINGS

ACCESSORIES

CONTROL
COMPONENTS

FLOW
MEASURING

TRALLE LOK

Adaptadores NPT

NPT Adaptors
Adapteurs NPT
Adattatori NPT

Codo 90° macho - macho NPT

90° elbow male NPT - male NPT

Coude 90° mâle NPT - mâle NPT

Adattatore a 90° maschio - maschio NPT



ROSCA THREAD		Referencia Part n°
1/8" NPT	1/8" NPT	ZN119002
1/4" NPT	1/4" NPT	ZN119004
3/8" NPT	3/8" NPT	ZN119006
1/2" NPT	1/2" NPT	ZN119008
3/4" NPT	3/4" NPT	ZN119012
1" NPT	1" NPT	ZN119016
1" 1/4 NPT	1" 1/4 NPT	ZN119020

Codo 90° macho NPT - hembra giratoria NPSM

90° elbow male NPT - swivel female NPSM

Coude 90° mâle NPT - femelle tournante NPSM

Adattatore a 90° maschio NPT - femmina girevole NPSM



ROSCA THREAD		Referencia Part n°
1/8" NPT	1/8" 27h NPSM	ZN11930202
1/4" NPT	1/4" - 18h NPSM	ZN11930404
1/4" NPT	3/8" - 18h NPSM	ZN11930406
3/8" NPT	3/8" - 18h NPSM	ZN11930606
3/8" NPT	1/2" - 14h NPSM	ZN11930608
1/2" NPT	1/2" - 14h NPSM	ZN11930808
1/2" NPT	3/4" - 14h NPSM	ZN11930812
3/4" NPT	1/2" - 14h NPSM	ZN11931208
3/4" NPT	3/4" - 14h NPSM	ZN11931212
3/4" NPT	1" - 11 1/2 h NPSM	ZN11931216
1" NPT	1" - 11 1/2 h NPSM	ZN11931616
1" 1/4 NPT	1" 1/4 - 11 1/2 h NPSM	ZN11932020

Codo 90° hembra fija - hembra fija NPT

90° elbow fixed female NPT - fixed female NPT

Coude 90° femelle fixe NPT - femelle fixe NPT

Adattatore a 90° femmina fissa - femmina fissa NPT



ROSCA THREAD		Referencia Part n°
1/8" NPT	1/8" NPT	ZN11960202
1/4" NPT	1/4" NPT	ZN11960404
3/8" NPT	3/8" NPT	ZN11960606
1/2" NPT	1/2" NPT	ZN11960808
3/4" NPT	3/4" NPT	ZN11961212
1" NPT	1" NPT	ZN11961616

Codo 45° macho - macho NPT

45° elbow male NPT - male NPT

Coude 45° mâle NPT - mâle NPT

Adattatore a 45° maschio - maschio NPT



ROSCA THREAD		Referencia Part n°
1/4" NPT	1/4" NPT	ZN119804
3/8" NPT	3/8" NPT	ZN119806
1/2" NPT	1/2" NPT	ZN119808
3/4" NPT	3/4" NPT	ZN119812
1" NPT	1" NPT	ZN119816

Codo 45° hembra fija- hembra fija NPT

45° elbow fixed female NPT - fixed female NPT

Coude 45° femelle fixe NPT - femelle fixe NPT

Adattatore a 45° femmina fissa - femmina fissa NPT



ROSCA THREAD		Referencia Part n°
1/4" NPT	1/4" NPT	ZN139604
3/8" NPT	3/8" NPT	ZN139606
1/2" NPT	1/2" NPT	ZN139608
3/4" NPT	3/4" NPT	ZN139612
1" NPT	1" NPT	ZN139616

Codo 45° macho NPT - hembra giratoria NPSM

45° elbow male NPT - swivel female NPSM

Coude 45° mâle NPT - swivel female NPSM

Adattatore a 45° maschio NPT - femmina girevole NPSM



ROSCA THREAD		Referencia Part n°
1/4" NPT	1/4" - 18h NPSM	ZN139304
3/8" NPT	3/8" - 18h NPSM	ZN139306
1/2" NPT	1/2" - 14h NPSM	ZN139308
3/4" NPT	3/4" - 14h NPSM	ZN139312
1" NPT	1" - 11 1/2 h NPSM	ZN139316

Adaptadores NPT

NPT Adaptors
 Adapteurs NPT
 Adattatori NPT

Tes macho-macho-macho NPT

NPT male tee

Té mâle NPT

Adattatore a T maschio conico NPT



ROSCA THREAD			Referencia Part n°
1/8" NPT	1/8" NPT	1/8" NPT	ZN122002
1/4" NPT	1/4" NPT	1/4" NPT	ZN122004
3/8" NPT	3/8" NPT	3/8" NPT	ZN122006
1/2" NPT	1/2" NPT	1/2" NPT	ZN122008
3/4" NPT	3/4" NPT	3/4" NPT	ZN122012
1" NPT	1" NPT	1" NPT	ZN122016

Tes hembra fija-hembra fija-hembra fija NPT

NPT fixed female tee

Té femelle fixe NPT

Adattatore a T femmina fissa NPT



ROSCA THREAD			Referencia Part n°
1/8" NPT	1/8" NPT	1/8" NPT	ZN122602
1/4" NPT	1/4" NPT	1/4" NPT	ZN122604
3/8" NPT	3/8" NPT	3/8" NPT	ZN122606
1/2" NPT	1/2" NPT	1/2" NPT	ZN122608
3/4" NPT	3/4" NPT	3/4" NPT	ZN122612
1" NPT	1" NPT	1" NPT	ZN122616

CRIMPING FITTINGS
FOR HOSES

PIPE
FITTINGS

PIPE
FITTINGS II

ADAPTORS

WELDING
FITTINGS

INDUSTRIAL
FITTINGS

ACCESSORIES

CONTROL
COMPONENTS

FLOW
MEASURING

TRALE LOK

Adaptadores O'Ring Boss

O'Ring Boss Adaptors
Adapteurs O'Ring Boss
Adattatori O'Ring Boss

Adaptador macho - macho O'Ring Boss

Adaptor male - male O'Ring Boss

Adapteur mâle - mâle O'Ring Boss

Adattatore maschio-maschio o-ring Boss



TUBO PIPE	ROSCA THREAD	Referencia Part n°
6	1/4" 7/16"-20h UNF	ZS64640606
8	5/16" 1/2"-20h UNF	ZS64640808
10	3/8" 9/16"-18h UNF	ZS64641010
12	1/2" 3/4"-16h UNF	ZS64641212
14-15-16	5/8" 7/8"-14h UNF	ZS64641616
18-20	3/4" 1"1/16-12h UN	ZS64642020
25	1" 1"5/16-12h UN	ZS64642525

Adaptador macho O'Ring Boss - macho JIC 37º

Adaptor male O'Ring Boss - male JIC 37º

Adapteur mâle O'Ring Boss- mâle JIC 37º

Adattatore maschio o-ring Boss - maschio JIC 37º

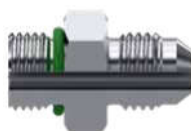

TUBO PIPE	ROSCA THREAD	Referencia Part n°
6	1/4" 7/16"-20h UNF	ZS22006
8	5/16" 1/2"-20h UNF	ZS22008
10	3/8" 9/16"-18h UNF	ZS22010
12	1/2" 3/4"-16h UNF	ZS22012
14-15-16	5/8" 7/8"-14h UNF	ZS22016
18-20	3/4" 1"1/16-12h UN	ZS22020
25	1" 1"5/16-12h UN	ZS22025
30-32	1"1/4" 1"5/8-12h UN	ZS22032
38	1"1/2" 1"7/8-12h UN	ZS22038

Adaptador macho O'Ring Boss - macho regulable O'Ring Bo

Adaptor male O'Ring Boss - adjustable male O'Ring Boss

Adapteur mâle O'Ring Boss - mâle réglable O'Ring Boss

Adattatore maschio o-ring Boss - maschio regolabile o-ring Boss



TUBO PIPE	ROSCA THREAD	Referencia Part n°
6	1/4" 7/16"-20h UNF	ZS34740606
10	3/8" 9/16"-18h UNF	ZS34741010
12	1/2" 3/4"-16h UNF	ZS34741212
14-15-16	5/8" 7/8"-14h UNF	ZS34741616
18-20	3/4" 1"1/16-12h UN	ZS34742020
25	1" 1"5/16-12h UN	ZS34742525

Adaptador macho O'Ring Boss - macho NPT

Adaptor male O'Ring Boss - male NPT

Adapteur mâle O'Ring Boss- mâle NPT

Adattatore maschio o-ring Boss - maschio NPT

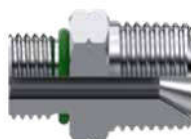

TUBO PIPE	ROSCA THREAD	Referencia Part n°
6	1/4" 7/16"-20h UNF	ZS64010613
10	3/8" 9/16"-18h UNF	ZS64011017
12	1/2" 3/4"-16h UNF	ZS64011221
14-15-16	5/8" 7/8"-14h UNF	ZS64011621
18-20	3/4" 1"1/16-12h UN	ZS64012026
25	1" 1"5/16-12h UN	ZS64012533

Adaptador macho O'Ring Boss - hembra giratoria JIC 37º

Adaptor male O'Ring Boss - swivel female JIC 37º

Adapteur mâle O'Ring Boss - femelle tournante JIC 37º

Adattatore maschio o-ring Boss - femmina gir. JIC 37º



TUBO PIPE	ROSCA (H) THREAD (F)	ROSCA (M) THREAD (M)	Referencia Part n°
6	1/4" 7/16" 20h UNF	7/16" 20h UNF	ZS38006
10	3/8" 9/16" 18h UNF	9/16" 18h UNF	ZS38010
12	1/2" 3/4" 16h UNF	3/4" 16h UNF	ZS38012
14-15-16	5/8" 7/8" 14h UNF	7/8" 14h UNF	ZS38016
18-20	3/4" 1"1/16 12h UN	1"1/16 12h UN	ZS38020
25	1" 1"5/16 12h UN	1"5/16 12h UN	ZS38025

Prolongador macho O'Ring Boss - hembra fija NPT

Adaptor male O'Ring Boss - fixed female NPT

Prolongateur mâle O'Ring Boss - femelle fixe NPT

Prolunga machio o-ring Boss - femmina fissa NPT

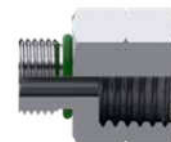

TUBO PIPE	ROSCA THREAD	Referencia Part n°
6	1/4" 7/16"-20h UNF	ZS64050613
10	3/8" 9/16"-18h UNF	ZS64051017
12	1/2" 3/4"-16h UNF	ZS64051221
14-15-16	5/8" 7/8"-14h UNF	ZS64051621
18-20	3/4" 1"1/16-12h UN	ZS64052026
25	1" 1"5/16-12h UN	ZS64052533

Tapón macho O'Ring Boss hexagonal

Male hexagonal O'Ring Boss plug

Bouchon mâle O'Ring Boss hexagonal

Tappo maschio o-ring Boss testa esagonale



ROSCA THREAD	Referencia Part n°
7/16"-20h UNF	ZS640806
1/2"-20h UNF	ZS640808
9/16"-18h UNF	ZS640810
3/4"-16h UNF	ZS640812
7/8"-14h UNF	ZS640816
1"1/16-12h UN	ZS640820
1"5/16-12h UN	ZS640825

Tapón macho O'Ring Boss Allen

Male allen O'Ring Boss plug

Bouchon mâle O'Ring Boss allen

Tappo maschio o-ring Boss esagono incassato



ROSCA THREAD	Referencia Part n°
7/16"-20h UNF	ZS640906
1/2"-20h UNF	ZS640908
9/16"-18h UNF	ZS640910
3/4"-16h UNF	ZS640912
7/8"-14h UNF	ZS640916
1"1/16-12h UN	ZS640920
1"5/16-12h UN	ZS640925

CRIMPING FITTINGS
FOR HOSES

PIPE
FITTINGS

PIPE
FITTINGS II

ADAPTORS

WELDING
FITTINGS

INDUSTRIAL
FITTINGS

ACCESSORIES

CONTROL
COMPONENTS

FLOW
MEASURING

TRAILER LOK

Adaptadores O'Ring Boss

O'Ring Boss Adaptors
Adapteurs O'Ring Boss
Adattatori O'Ring Boss

Codo 90º regulable macho O'Ring Boss - macho JIC 37º

90º Adjustable elbow male O'Ring Boss -male JIC 37º

Coude 90º orientable mâle O'Ring Boss - mâle JIC 37º

Curva a 90º regolabile maschio o-ring Boss - maschio JIC 37º



TUBO PIPE	ROSCA THREAD	Referencia Part nº
6 1/4"	7/16"-20h UNF	ZS57506
8 5/16"	1/2"-20h UNF	ZS57508
10 3/8"	9/16"-18h UNF	ZS57510
12 1/2"	3/4"-16h UNF	ZS57512
14-15-16 5/8"	7/8"-14h UNF	ZS57516
18-20 3/4"	1"1/16-12h UN	ZS57520
25 1"	1"5/16-12h UN	ZS57525

Te regulable macho JIC 37º - macho O'Ring Boss - macho JIC 37º

Adjustable Tee male JIC 37º - male O'Ring Boss - male JIC 37º

Té orientable macho JIC 37º - macho O'Ring Boss - macho JIC 37º

Tee regolabile maschio JIC 37º - maschio o-ring Boss- maschio JIC 37º



TUBO PIPE	ROSCA THREAD	Referencia Part nº
6 1/4"	7/16"-20h UNF	ZS680406
8 5/16"	1/2"-20h UNF	ZS680408
10 3/8"	9/16"-18h UNF	ZS680410
12 1/2"	3/4"-16h UNF	ZS680412
14-15-16 5/8"	7/8"-14h UNF	ZS680416
18-20 3/4"	1"1/16-12h UN	ZS680420
25 1"	1"5/16-12h UN	ZS680425

Te regulable macho O'Ring Boss - macho JIC 37º - macho

Adjustable Tee male O'Ring Boss - male JIC 37º - male JIC 37º

Té orientable macho O'Ring Boss - macho JIC 37º - macho JIC 37º

Tee regolabile maschio o-ring Boss - maschio JIC 37º - maschio JIC 37º



TUBO PIPE	ROSCA THREAD	Referencia Part nº
6 1/4"	7/16"-20h UNF	ZS680306
8 5/16"	1/2"-20h UNF	ZS680308
10 3/8"	9/16"-18h UNF	ZS680310
12 1/2"	3/4"-16h UNF	ZS680312
14-15-16 5/8"	7/8"-14h UNF	ZS680316
18-20 3/4"	1"1/16-12h UN	ZS680320
25 1"	1"5/16-12h UN	ZS680325

Adaptadores ORFS

ORFS Adaptors
Adapteurs ORFS
Adattatori ORFS

Tuerca ORFS

ORFS Nut

Écrou ORFS

Dado ORFS



TUBO PIPE	ROSCA THREAD	Referencia Part n°
6-8	ORFS 9/16"-18h	ZOR1020400
10	ORFS 11/16"-16h	ZOR1020600
12	ORFS 13/16"-16h	ZOR1020800
14-15-16	ORFS 1"-14h	ZOR1021000
18-20	ORFS 1"3/16-12h	ZOR1021200
22-25	ORFS 1"7/16-12h	ZOR1021600
28-30-32	ORFS 1"11/16-12h	ZOR1022000
35-38	ORFS 2"-12h	ZOR1022400

Cono soldar ORFS

ORFS Welding nipple

Collet à souder ORFS

Ogiva a saldare ORFS



TUBO PIPE	ROSCA THREAD	Referencia Part n°
6	ORFS 9/16"-18h	ZOR12730406
8	ORFS 9/16"-18h	ZOR12730408
10	ORFS 11/16"-16h	ZOR12730610
12	ORFS 13/16"-16h	ZOR12730812
14	ORFS 1"-14h	ZOR12731014
15	ORFS 1"-14h	ZOR12731015
16	ORFS 1"-14h	ZOR12731016
18	ORFS 1" 3/16-12h	ZOR12731218
20	ORFS 1" 3/16-12h	ZOR12731220
22	ORFS 1" 7/16-12h	ZOR12731622
30	ORFS 1"11/16-12h	ZOR12732030
32	ORFS 1"11/16-12h	ZOR12732032
38	ORFS 2"-12h	ZOR12732438

Tapón macho ORFS

ORFS Male plug

Bouchon mâle ORFS

Tappo maschio ORFS



ROSCA THREAD	Referencia Part n°
ORFS 9/16"-18h	ZOR1040400
ORFS 11/16"-16h	ZOR1040600
ORFS 13/16"-16h	ZOR1040800
ORFS 1"-14h	ZOR1041000
ORFS 1"3/16-12h	ZOR1041200
ORFS 1"7/16-12h	ZOR1041600
ORFS 1"11/16-12h	ZOR1042000
ORFS 2"-12h	ZOR1042400

Tapón hembra ORFS

ORFS cap

Bouchon femelle ORFS

Tappo femmina ORFS



ROSCA THREAD	Referencia Part n°
ORFS 9/16"-18h	ZOR1050400
ORFS 11/16"-16h	ZOR1050600
ORFS 13/16"-16h	ZOR1050800
ORFS 1"-14h	ZOR1051000
ORFS 1"3/16-12h	ZOR1051200
ORFS 1"7/16-12h	ZOR1051600
ORFS 1"11/16-12h	ZOR1052000
ORFS 2"-12h	ZOR1052400

Adaptador macho-macho ORFS

ORFS Male adaptor

Adapteur mâle ORFS

Adattatore maschio-maschio ORFS



ROSCA THREAD	ROSCA THREAD	Referencia Part n°
ORFS 9/16"-18h	ORFS 9/16"-18h	ZOR2000404
ORFS 11/16"-16h	ORFS 11/16"-16h	ZOR2000606
ORFS 13/16"-16h	ORFS 13/16"-16h	ZOR2000808
ORFS 1"-14h	ORFS 1"-14h	ZOR2001010
ORFS 1"3/16-12h	ORFS 1"3/16-12h	ZOR2001212
ORFS 1"7/16-12h	ORFS 1"7/16-12h	ZOR2001616
ORFS 1"11/16-12h	ORFS 1"11/16-12h	ZOR2002020
ORFS 2"-12h	ORFS 2"-12h	ZOR2002424

Adaptador macho ORFS-macho BSP

ORFS Male - BSP Male

Adapteur mâle ORFS - mâle BSP

Adattatore maschio ORFS- maschio BSP con
guarnizione

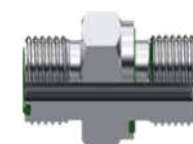

ROSCA THREAD	ROSCA THREAD	Referencia Part n°
ORFS 9/16"-18h	BSP 1/4"	ZOR2020404
ORFS 11/16"-16h	BSP 3/8"	ZOR2020606
ORFS 13/16"-16h	BSP 3/8"	NEW ZOR2020806
ORFS 13/16"-16h	BSP 1/2"	ZOR2020808
ORFS 1"3/16-12h	BSP 1/2"	ZOR2021208
ORFS 1"3/16-12h	BSP 3/4"	ZOR2021212
ORFS 1"7/16-12h	BSP 1"	ZOR2021616
ORFS 1"7/16-12h	BSP 1" 1/4	ZOR2021620
ORFS 1"11/16-12h	BSP 1"	NEW ZOR2022016
ORFS 1"11/16-12h	BSP 1" 1/4	ZOR2022020
ORFS 2"-12h	BSP 1" 1/2	ZOR2022424

CRIMPING FITTINGS
FOR HOSES

PIPE
FITTINGS

PIPE
FITTINGS II

ADAPTORS

WELDING
FITTINGS

INDUSTRIAL
FITTINGS

ACCESSORIES

CONTROL
COMPONENTS

FLOW
MEASURING

TRALE LOK

CRIMPING FITTINGS
FOR HOSES

PIPE
FITTINGS

PIPE
FITTINGS II

ADAPTORS

WELDING
FITTINGS

INDUSTRIAL
FITTINGS

ACCESSORIES

CONTROL
COMPONENTS

FLOW
MEASURING

TRALLE LOK

Adaptadores ORFS

ORFS Adaptors
Adapteurs ORFS
Adattatori ORFS

Adaptador macho ORFS-macho Métrico

ORFS Male - Metric Male

Adapteur mâle ORFS - mâle Métrique

Adattatore maschio ORFS - maschio metrico con guarnizione

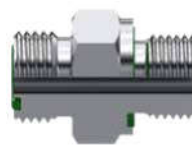

ROSCA THREAD		Referencia Part n°
ORFS 9/16"-18h	M12x1,5	ZOR10170412
ORFS 11/16"-16h	M16x1,5	ZOR10170616
ORFS 13/16"-16h	M18x1,5	ZOR10170818
ORFS 1"-14h	M22x1,5	ZOR10171022
ORFS 1"7/16-12h	M33x2	ZOR10171633
ORFS 1"11/16-12h	M42x2	ZOR10172042
ORFS 2"-12h	M48x2	ZOR10172448

Pasatabiques ORFS

ORFS Bulkhead

Passé-cloison ORFS

Passaparete ORFS

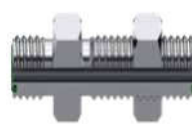

ROSCA THREAD	Referencia Part n°	
ORFS 9/16"-18h	ZOR1060404	
ORFS 11/16"-16h	ZOR1060606	
ORFS 13/16"-16h	ZOR1060808	
ORFS 1"-14h	ZOR1061010	
ORFS 1"3/16-12h	ZOR1061212	
ORFS 1"7/16-12h	ZOR1061616	
ORFS 1"11/16-12h	ZOR1062020	
ORFS 2"-12h	ZOR1062424	18

Adaptador macho-hembra giratoria ORFS

ORFS Male - ORFS Swivel female

Adapteur mâle - femelle tournante ORFS

Adattatore femmina girevole ORFS-maschio ORFS



ROSCA (H) THREAD (F)	ROSCA (M) THREAD (M)	Referencia Part n°
ORFS 9/16"-18h	ORFS 11/16"-16h	ZOR3010406
ORFS 11/16"-16h	ORFS 9/16"-18h	ZOR3010604
ORFS 13/16"-16h	ORFS 9/16"-18h	ZOR3010804
ORFS 13/16"-16h	ORFS 11/16"-16h	ZOR3010806
ORFS 1"-14h	ORFS 9/16"-18h	ZOR3011004
ORFS 1"-14h	ORFS 11/16"-16h	ZOR3011006
ORFS 1"-14h	ORFS 13/16"-16h	ZOR3011008
ORFS 1"3/16-12h	ORFS 11/16"-16h	ZOR3011206
ORFS 1"3/16-12h	ORFS 13/16"-16h	ZOR3011208
ORFS 1"3/16-12h	ORFS 1"-14h	ZOR3011210
ORFS 1"7/16-12h	ORFS 13/16"-16h	ZOR3011608
ORFS 1"7/16-12h	ORFS 1"-14h	ZOR3011610
ORFS 1"7/16-12h	ORFS 1"3/16-12h	ZOR3011612
ORFS 1"11/16-12h	ORFS 1"3/16-12h	ZOR3012012
ORFS 1"11/16-12h	ORFS 1"7/16-12h	ZOR3012016

Adaptador macho ORFS-macho JIC 37°

ORFS Male - 37° JIC Male

Adapteur mâle ORFS - mâle JIC 37°

Adattatore maschio ORFS-JIC 37°



ROSCA THREAD		Referencia Part n°
ORFS 9/16"-18h	JIC 7/16"	ZOR2040404
ORFS 11/16"-16h	JIC 9/16"	ZOR2040606
ORFS 13/16"-16h	JIC 3/4"	ZOR2040808
ORFS 1"-14h	JIC 7/8"	ZOR2041010
ORFS 1"3/16-12h	JIC 1"1/16	ZOR2041212
ORFS 1"7/16-12h	JIC 1"5/16	ZOR2041616
ORFS 1"11/16-12h	JIC 1"5/8	ZOR2042020
ORFS 2"-12h	JIC 1"7/8	ZOR2042424

Adaptador macho ORFS-hembra giratoria JIC 37°

ORFS Male - 37° JIC Swivel female

Adapteur mâle ORFS - femelle tournante JIC 37°

Adattatore maschio ORFS-femmina girevole JIC 37°



ROSCA THREAD		Referencia Part n°
ORFS 9/16"-18h	JIC 7/16"	ZOR3020404
ORFS 11/16"-16h	JIC 9/16"	ZOR3020606
ORFS 13/16"-16h	JIC 3/4"	ZOR3020808
ORFS 1"-14h	JIC 7/8"	ZOR3021010
ORFS 1"3/16-12h	JIC 1"1/16	ZOR3021212
ORFS 1"7/16-12h	JIC 1"5/16	ZOR3021616
ORFS 1"11/16-12h	JIC 1"5/8	ZOR3022020
ORFS 2"-12h	JIC 1"7/8	ZOR3022424

Adaptador macho JIC 37°-hembra giratoria ORFS

JIC Male - ORFS Swivel female

Adapteur mâle JIC 37° - femelle tournante ORFS

Adattatore maschio JIC 37° -femmina girevole ORFS



ROSCA THREAD		Referencia Part n°
JIC 7/16"	ORFS 9/16"-18 h	ZOR3050404
JIC 9/16"	ORFS 11/16"-16h	ZOR3050606
JIC 3/4"	ORFS 13/16"-16 h	ZOR3050808
JIC 7/8"	ORFS 1"-14h	ZOR3051010
JIC 1"1/16	ORFS 1"3/16-12 h	ZOR3051212
JIC 1"5/16	ORFS 1"7/16-12 h	ZOR3051616
JIC 1"5/8	ORFS 1"11/16"-12h	ZOR3052020
JIC 1"7/8"	ORFS 2"-12h	ZOR3052424

Adaptadores ORFS

ORFS Adaptors
Adaptateurs ORFS
Adattatori ORFS

Codo 90° macho-macho ORFS

90° ORFS male - ORFS male

Coude 90° mâle ORFS - mâle ORFS

Adattatore 90° maschio-maschio ORFS



ROSCA THREAD	Referencia Part n°
ORFS 9/16"-18h	ZOR4050404
ORFS 11/16"-16h	ZOR4050606
ORFS 13/16"-16h	ZOR4050808
ORFS 1"-14h	ZOR4051010
ORFS 1"3/16-12h	ZOR4051212
ORFS 1"7/16-12h	ZOR4051616
ORFS 1"11/16-12h	ZOR4052020
ORFS 2"-12h	ZOR4052424

Codo 90° macho-hembra giratoria ORFS

90° ORFS swivel female - ORFS male

Coude 90° femelle tournante ORFS- mâle ORFS

Adattatore 90° maschio-femmina girevole ORFS



ROSCA (M) THREAD (M)	ROSCA (H) THREAD (F)	Referencia Part n°
ORFS 9/16"-18h	ORFS 9/16"-18h	ZOR6000404
ORFS 11/16"-16h	ORFS 11/16"-16h	ZOR6000606
ORFS 13/16"-16h	ORFS 13/16"-16h	ZOR6000808
ORFS 1"-14h	ORFS 1"-14h	ZOR6001010
ORFS 1"3/16-12h	ORFS 1"3/16-12h	ZOR6001212
ORFS 1"7/16-12h	ORFS 1"7/16-12h	ZOR6001616
ORFS 1"11/16-12h	ORFS 1"11/16-12h	ZOR6002020

Te macho-macho-macho ORFS

ORFS Male Tee

Té Mâle ORFS

Adattatore a T maschio ORFS



ROSCA THREAD	Referencia Part n°
ORFS 9/16"-18h	ZOR7000404
ORFS 11/16"-16h	ZOR7000606
ORFS 13/16"-16h	ZOR7000808
ORFS 1"-14h	ZOR7001010
ORFS 1"3/16-12h	ZOR7001212
ORFS 1"7/16-12h	ZOR7001616
ORFS 1"11/16-12h	ZOR7002020
ORFS 2"-12h	ZOR7002424

Te macho-hembra giratoria-macho ORFS

ORFS Male-Swivel female-Male Tee

Té Mâle-Femelle tournante-Mâle ORFS

Adattatore a T maschio-femmina girevole centrale-maschio ORFS



ROSCA THREAD	Referencia Part n°	€
ORFS 9/16"-18h	ZOR7010404	66,78
ORFS 11/16"-16h	ZOR7010606	68,27
ORFS 13/16"-16h	ZOR7010808	74,95
ORFS 1"-14h	ZOR7011010	107,75
ORFS 1"3/16-12h	ZOR7011212	144,10
ORFS 1"7/16-12h	ZOR7011616	175,17
ORFS 1"11/16-12h	ZOR7012020	216,23
ORFS 2"-12h	ZOR7012424	284,43

Te macho-macho-hembra giratoria ORFS

ORFS Male-Male-Swivel Female Tee

Té Mâle-Mâle-Femelle tournante ORFS

Adattatore a T maschio-maschio-femmina girevole laterale ORFS



ROSCA THREAD	Referencia Part n°	€
ORFS 9/16"-18h	ZOR7020404	66,78
ORFS 11/16"-16h	ZOR7020606	70,22
ORFS 13/16"-16h	ZOR7020808	77,95
ORFS 1"-14h	ZOR7021010	107,75
ORFS 1"3/16-12h	ZOR7021212	142,44
ORFS 1"7/16-12h	ZOR7021616	175,17
ORFS 1" 11/16-12h	ZOR7022020	198,58

Juntas tóricas FKM verde para rosca ORFS

O'ring FKM green for ORFS thread

Joint torique FKM vert pour filetage ORFS

O'ring FKM verde per filetto ORFS



ROSCA THREAD	Referencia Part n°
ORFS 9/16"-18h	JVORFS04
ORFS 11/16"-16h	JVORFS06
ORFS 13/16"-16h	JVORFS08
ORFS 1"-14h	JVORFS10
ORFS 1"3/16-12h	JVORFS12
ORFS 1"7/16-12h	JVORFS16
ORFS 1" 11/16-12h	JVORFS20
ORFS 2"-12h	JVORFS24

CRIMPING FITTINGS
FOR HOSES

PIPE
FITTINGS

PIPE
FITTINGS II

ADAPTORS

WELDING
FITTINGS

INDUSTRIAL
FITTINGS

ACCESSORIES

CONTROL
COMPONENTS

FLOW
MEASURING

TRALE LOK

Racores soldables 195

Welding fittings
Embouts à souder
Raccordi a saldare

Bridas soldables 203

Welding flanges
Brides à souder
Flangia a saldare



05

| RACORES SOLDABLES

Welding fittings

Embouts à souder

Raccordi a saldare

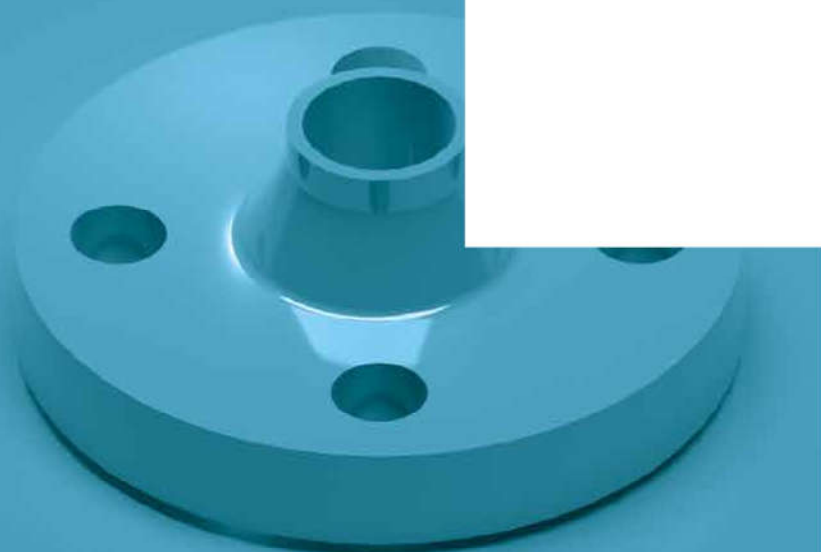

CRIMPING FITTINGS
FOR HOSES

PIPE
FITTINGS

PIPE
FITTINGS II

ADAPTORS

WELDING
FITTINGS

INDUSTRIAL
FITTINGS

ACCESSORIES

CONTROL
COMPONENTS

FLOW
MEASURING

TRALE LOK

Racores soldables

Welding fittings
Embouts à souder
Raccordi a saldare

Racores macho para soldar ▪ Welding Male ▪ Raccords mâle à souder ▪ Maschio a saldare | 195



Racores BSP para soldar ▪ Welding BSP nuts ▪ Écrous tournants à souder ▪ Raccordi BSP a saldare | 196



Racores JIC para soldar ▪ Welding JIC fittings ▪ Raccords JIC à souder ▪ Raccordi JIC a saldare | 197



Racores Métricos para soldar ▪ Welding metric fittings ▪ Raccords métriques à souder ▪ Raccordi metrici a saldare | 198



BSP >2" ▪ Welding fittings >2" ▪ Raccords à souder >2" ▪ Raccordi a saldare > 2" | 200



Conos ajuste BSP ▪ Other welding BSP fittings ▪ Autres raccords à souder BSP ▪ Raccordi a saldare vari BSP | 201



Conos ajuste JIC ▪ Other welding JIC fittings ▪ Autres raccords à souder JIC ▪ Raccordi a saldare vari JIC | 201



Racores Microfundido para soldar ▪ Welding fittings microcast ▪ Raccords à souder micro-moulés ▪ Raccordi per saldatura microfuso | 202



Bridas soldables

Welding flanges
Brides à souder
Flangia a saldare

Bridas fijas para soldar ▪ Fixed Forged flanges ▪ Brides DIN à souder fixes ▪ Flange a saldare

203



ZBPN162633

ZBPN402635

ZBANSAWN150

ZBANSAWN300

Conjunto bridas DIN 2642 ▪ DIN 2642 swivel flanges set ▪ Ensemble brides tournantes DIN 2642 ▪ Flangia girevole DIN 2642

204



ZBPN102642

ZABARO2642

ZBTUBO

Conjunto bridas DIN 2656 ▪ DIN 2656 swivel flanges set ▪ Ensemble brides tournantes DIN 2656 ▪ Flangia girevole DIN 2656

205



ZBPN402656

ZABARO2656

ZBTUBO

Conjunto bridas ANSI-ASA ▪ ANSI-ASA swivel flanges set ▪ Ensemble brides ANSI-ASA ▪ Flangia girevole ANSI-ASA

206



ZBANSASO150

ZBANSASO300

ZABAROANSA

ZBTUBO

CRIMPING FITTINGS
FOR HOSES

PIPE
FITTINGS

PIPE
FITTINGS II

ADAPTORS

WELDING
FITTINGS

INDUSTRIAL
FITTINGS

ACCESSORIES

CONTROL
COMPONENTS

FLOW
MEASURING

TRALE LOK

Racores soldables

Welding fittings
Embouts à souder
Raccordi a saldare

Casquillo soldable

Welding ferrule

Jupe à souder

Boccola a saldare



DN	Ø INT. Ø INNER	Referencia Part n°	€
1/4"	14	810700400	1,67
1/4"	12	810700401	1,80
3/8"	19	810700600	2,60
3/8"	17	810700601	1,91
1/2"	22	810700800	2,44
1/2"	19	810700801	2,44
5/8"	25	810701000	2,83
3/4"	30	810701200	3,01
3/4"	32	810701201	3,30
1"	35	810701500	3,45
1"	37	810701600	5,56
1 1/4"	47,8	810702000	6,34
1 1/4"	44,3	810702001	6,13
1 1/2"	56,3	810702400	7,41
2"	66	810703201	11,54
2 1/2"	84,9	810704000	15,48
2 1/2"	95,6	810704001	23,17
3"	100	810704801	27,05
4"	125	810706400	35,86

Macho soldable BSP cono 60° con guía

Welding BSP 60° Male with guide

Mâle gaz BSP 60° à souder avec guide

Maschio a saldare BSP 60° con guida



ROSCA THREAD	DN	Referencia Part n°	€
1/4" BSP	1/4"	Z103504	12,58
3/8" BSP	3/8"	Z103506	12,67
1/2" BSP	1/2"	Z103508	13,54
3/4" BSP	3/4"	Z103512	18,89
1" BSP	1"	Z103516	30,27
1 1/4" BSP	1 1/4"	Z103520	48,87
1 1/2" BSP	1 1/2"	Z103524	67,74
2" BSP	2"	Z103532	85,36

Macho BSP 60° soldable interior

Inside welding BSP Male

Mâle à souder int. BSP

Maschio BSP 60° a saldare interno



ROSCA THREAD	DN	Referencia Part n°	€
1/4" BSP	1/4"	Z1035104	13,31
3/8" BSP	3/8"	Z1035106	17,03
1/2" BSP	1/2"	Z1035108	18,31
3/4" BSP	3/4"	Z1035112	23,71
1" BSP	1"	Z1035116	32,00
1 1/4" BSP	1 1/4"	Z1035120	49,10
1 1/2" BSP	1 1/2"	Z1035124	59,41
2" BSP	2"	Z1035132	99,65

Macho soldable BSP asiento plano con guía

Welding BSP Male flat seat with guide

Mâle gaz BSP fond plat à souder avec guide

Maschio a saldare BSP faccia piana con guida



ROSCA THREAD	DN	Referencia Part n°	€
1/4" BSP	1/4"	Z103304	12,13
3/8" BSP	3/8"	Z103306	19,41
1/2" BSP	1/2"	Z103308	14,85
3/4" BSP	3/4"	Z103312	19,69
1" BSP	1"	Z103316	31,51
1 1/4" BSP	1 1/4"	Z103320	59,63
1 1/2" BSP	1 1/2"	Z103324	79,86
2" BSP	2"	Z103332	108,32

Empalme liso soldable macho BSP 60°

Welding male BSP 60° union

Embout mâle lisse à souder BSP cône 60°

Mezzo Niples tondo maschio a saldare BSP 60°



ROSCA THREAD	DN	Referencia Part n°	€
1/8" BSP	1/8"	Z129002	8,06
1/4" BSP	1/4"	Z129004	8,26
3/8" BSP	3/8"	Z129006	10,31
1/2" BSP	1/2"	Z129008	10,49
3/4" BSP	3/4"	Z129012	17,67
1" BSP	1"	Z129016	25,06
1 1/4" BSP	1 1/4"	Z129020	34,45
1 1/2" BSP	1 1/2"	Z129024	45,39
2" BSP	2"	Z129032	98,75

Macho soldable BSPT cono 60° con guía

Welding BSPT Male 60° with guide

Mâle gaz conique à souder 60° avec guide

Maschio conico BSPT 60° con guida



ROSCA THREAD	DN	Referencia Part n°	€
1/4" BSPT	1/4"	Z103204	11,45
3/8" BSPT	3/8"	Z103206	14,19
1/2" BSPT	1/2"	Z103208	13,77
3/4" BSPT	3/4"	Z103212	19,31
1" BSPT	1"	Z103216	27,20
1 1/4" BSPT	1 1/4"	Z103220	48,74
1 1/2" BSPT	1 1/2"	Z103224	55,65
2" BSPT	2"	Z103232	94,84

CRIMPING FITTINGS
FOR HOSES

PIPE
FITTINGS

PIPE
FITTINGS II

ADAPTORS

WELDING
FITTINGS

INDUSTRIAL
FITTINGS

ACCESSORIES

CONTROL
COMPONENTS

FLOW
MEASURING

TRAILER LOK

Racores soldables

Welding fittings
Embouts à souder
Raccordi a saldare

Macho soldable NPT cono 60° con guía

Welding NPT Male 60° with guide

Mâle NPT à souder 60° avec guide

Maschio a saldare NPT 60° con guida



ROSCA THREAD	DN	Referencia Part n°
1/8" NPT	1/4"	Z10340204
1/4" NPT	1/4"	Z10340400
3/8" NPT	3/8"	Z10340600
1/2" NPT	1/2"	Z10340800
3/4" NPT	3/4"	Z10341200
1" NPT	1"	Z10341600
1"1/4 NPT	1"1/4"	Z10342000
1"1/2 NPT	1"1/2"	Z10342400
2" NPT	2"	Z10343200

Hembra giratoria prensada soldable BSP 60° con gu

Welding BSP 60° swept with guide

Femelle tournante BSP 60° à souder avec guide

Femmina girevole a saldare BSP 60° con guida



ROSCA THREAD	DN	Referencia Part n°
1/4" BSP	1/4"	Z128104
3/8" BSP	3/8"	Z128106
1/2" BSP	1/2"	Z128108
3/4" BSP	3/4"	Z128112
1" BSP	1"	Z128116
1"1/4 BSP	1"1/4"	Z128120
1"1/2 BSP	1"1/2"	Z128124
2" BSP	2"	Z128132

Hembra giratoria 90° prensada soldable BSP 60°

Welding BSP 60° swept 90°

Femelle tournante à souder 90° BSP cône 60°

Femmina girevole 90° a saldare BSP 60°



ROSCA THREAD	DN	Referencia Part n°
1/4" BSP	1/4"	Z103704
3/8" BSP	3/8"	Z103706
1/2" BSP	1/2"	Z103708
3/4" BSP	3/4"	Z103712
1" BSP	1"	Z103716
1"1/4 BSP	1"1/4"	Z103720
1"1/2 BSP	1"1/2"	Z103724
2" BSP	2"	Z103732

Hembra giratoria 45° prensada soldable BSP 60°

Welding BSP 60° swept 45°

Femelle tournante à souder 45° BSP cône 60°

Femmina girevole 45° a saldare BSP 60°



ROSCA THREAD	DN	Referencia Part n°
1/4" BSP	1/4"	Z103804
3/8" BSP	3/8"	Z103806
1/2" BSP	1/2"	Z103808
3/4" BSP	3/4"	Z103812
1" BSP	1"	Z103816
1"1/4 BSP	1"1/4"	Z103820
1"1/2 BSP	1"1/2"	Z103824
2" BSP	2"	Z103832

Hembra giratoria prensada soldable BSP asiento plan

Welding BSP flat seat swept with guide

Femelle tournante BSP fond plat à souder avec guide

Femmina girevole a saldare BSP faccia piana con guida



ROSCA THREAD	DN	Referencia Part n°
1/4" BSP	1/4"	Z128204
3/8" BSP	3/8"	Z128206
1/2" BSP	1/2"	Z128208
3/4" BSP	3/4"	Z128212
1" BSP	1"	Z128216
1"1/4 BSP	1"1/4"	Z128220
1"1/2 BSP	1"1/2"	Z128224
2" BSP	2"	Z128232

Hembra giratoria 90° prensada soldable BSP asiento

Welding BSP Female 90° flat seat swept

Femelle tournante à souder 90° BSP fond plat

Femmina 90° girevole a saldare BSP faccia piana



ROSCA THREAD	DN	Referencia Part n°
1/4" BSP	1/4"	Z103904
3/8" BSP	3/8"	Z103906
1/2" BSP	1/2"	Z103908
3/4" BSP	3/4"	Z103912
1" BSP	1"	Z103916
1"1/4 BSP	1"1/4"	Z103920
1"1/2 BSP	1"1/2"	Z103924
2" BSP	2"	Z103932

Racores soldables

Welding fittings
Embouts à souder
Raccordi a saldare

Hembra giratoria 45° prensada soldable BSP asiento plano

Welding BSP Female 45° flat seat swept

Femelle tournante à souder 45° BSP fond plat

Femmina 45° girevole a saldare BSP faccia piana



ROSCA THREAD	DN	Referencia Part n°
1/4" BSP	1/4"	Z104004
3/8" BSP	3/8"	Z104006
1/2" BSP	1/2"	Z104008
3/4" BSP	3/4"	Z104012
1" BSP	1"	Z104016
1"1/4 BSP	1"1/4	Z104020
1"1/2 BSP	1"1/2	Z104024
2" BSP	2"	Z104032

Hembra giratoria prensada soldable JIC 37° con guía

Welding JIC female 37° swept with guide

Femelle tournante JIC 37° à souder avec guide

Femmina girevole a saldare JIC 37°



ROSCA THREAD	DN	Referencia Part n°
7/16" 20h UNF	1/4"	Z12830704
1/2" 20h UNF	1/4"	Z12830804
9/16" 18h UNF	3/8"	Z12830906
3/4" 16h UNF	3/8"	Z12831206
3/4" 16h UNF	1/2"	Z12831208
7/8" 14h UNF	1/2"	Z12831408
7/8" 14h UNF	5/8"	NEW Z12831410
1"1/16 12h UN	3/4"	Z12831712
1"5/16 12h UN	1"	Z12832116
1"5/8 12h UN	1"1/4	Z12832620
1"7/8 12h UN	1"1/2	Z12833024

Macho soldable JIC 37° con guía

Welding fixed male JIC 37° with guide

Mâle à souder JIC 37° avec guide

Maschio JIC 37° a saldare



ROSCA THREAD	DN	Referencia Part n°
7/16" 20h UNF	1/4"	Z10360704
1/2" 20h UNF	1/4"	Z10360804
9/16" 18h UNF	3/8"	Z10360906
3/4" 16h UNF	3/8"	Z10361206
3/4" 16h UNF	1/2"	Z10361208
7/8" 14h UNF	1/2"	Z10361408
7/8" 14h UNF	5/8"	Z10361410
1"1/16 12h UN	3/4"	Z10361712
1"5/16 12h UN	1"	Z10362116
1"5/8 12h UN	1"1/4	Z10362620
1"7/8 12h UN	1"1/4	Z10363020
1"7/8 12h UN	1"1/2	NEW Z10363024
2" 1/2 12h UN	2"	Z10364032

Hembra giratoria 90° prensada soldable JIC 37°

Welding 90° JIC Female 37° swept

Femelle tournante à souder 90° JIC 37°

Femmina 90° girevole a saldare JIC



ROSCA THREAD	DN	Referencia Part n°
7/16" 20h UNF	1/4"	Z10410704
1/2" 20h UNF	1/4"	Z10410804
9/16" 18h UNF	3/8"	Z10410906
3/4" 16h UNF	1/2"	Z10411208
7/8" 14h UNF	1/2"	Z10411408
1"1/16 12h UN	3/4"	Z10411712
1"5/16 12h UN	1"	Z10412116
1"5/8 12h UN	1"1/4	Z10412620
1"7/8 12h UN	1"1/2	Z10413024

Hembra giratoria 45° prensada soldable JIC 37°

Welding 45° JIC Female 37° swept

Femelle tournante à souder 45° JIC 37°

Femmina 45° girevole a saldare JIC



ROSCA THREAD	DN	Referencia Part n°
7/16" 20h UNF	1/4"	Z10420704
1/2" 20h UNF	1/4"	Z10420804
9/16" 18h UNF	3/8"	Z10420906
3/4" 16h UNF	1/2"	Z10421208
7/8" 14h UNF	1/2"	Z10421408
1"1/16 12h UN	3/4"	Z10421712
1"5/16 12h UN	1"	Z10422116
1"5/8 12h UN	1"1/4	Z10422620
1"7/8 12h UN	1"1/2	Z10423024

Hembra giratoria prensada soldable JIC 37° con guía doble hexágono

Welding JIC female 37° swept with guide double hexagon

Femelle tournante JIC 37° à souder avec guide double hex.

Femmina girevole a saldare JIC 37° doppio esagono



ROSCA THREAD	DN	Referencia Part n°	€
7/16" 20 UNF	1/4"	Z12840704	
1/2" 20 UNF	1/4"	Z12840804	
9/16" 18 UNF	3/8"	Z12840906	
3/4" 16 UNF	1/2"	Z12841208	
7/8" 14 UNF	1/2"	Z12841408	
7/8" 14 UNF	5/8"	NEW Z12841410	
1" 1/16 12 UN	3/4"	Z12841712	
1"5/16 12 UN	1"	Z12842116	
1"5/8 12 UN	1"1/4	Z12842620	
1"7/8 12 UN	1"1/2	Z12843024	
2" 1/2 12 UN	2"	NEW Z12844032	

Racores soldables

Welding fittings
Embouts à souder
Raccordi a saldare

Tuercas Métricas

DIN nut

Écrou DIN

Dado DIN



TUBO PIPE	ROSCA THREAD	Referencia Part n°
6	M12X1,5	Z10510612
6	M14X1,5	Z10510614
8	M14X1,5	Z10510814
8	M16X1,5	Z10510816
10	M16X1,5	Z10511016
10	M18X1,5	Z10511018
12	M18X1,5	Z10511218
12	M20X1,5	Z10511220
14	M22X1,5	Z10511422
15	M22X1,5	Z10511522
16	M24X1,5	Z10511624
18	M26X1,5	Z10511826
20	M30X2	Z10512030
22	M30X2	Z10512230
25	M36X2	Z10512536
28	M36X2	Z10512836
30	M42X2	Z10513042
35	M45X2	Z10513545
38	M52X2	Z10513852
42	M52X2	Z10514252

Boquilla para soldar cono metal

Welding metal cone nipple

Raccord collet cône métallique à souder

Ogiva a saldare senza o'ring



TUBO PIPE	SERIE	Referencia Part n°
15X2,5	L	Z CMORIL 15
18X2,5	L	Z CMORIL 18
22X2,5	L	Z CMORIL 22
28X3	L	Z CMORIL 28
35X4	L	Z CMORIL 35
42X3	L	Z CMORIL 42
6X2	L/S	Z CMORIS 6
8X2	L/S	Z CMORIS 8
10X2	L/S	Z CMORIS 10
12X2	L/S	Z CMORIS 12
14X3	S	Z CMORIS 14
16X3	S	Z CMORIS 16
20X3	S	Z CMORIS 20
25X4	S	Z CMORIS 25
30X5	S	Z CMORIS 30
38X5	S	Z CMORIS 38

En caso de querer la pieza con junta, ver pág. 118 / If you want the item with o'ring, please
vous voulez la pièce avec le joint, voir page 118 / En caso de querer la pieza con junta, ver pág

/ Si

Espiga lisa métrica recta

Welding metric standpipe

Embout lisse métrique à souder

Estremità tubolare metrica diritta



Ø EXT. Ø OUTER	Ø INT. Ø INNER	Referencia Part n°
10	7	KZL0010
12	9	KZL0012
14	10	KZL0014
15	12	KZL0015
16	12	KZL0016
18	14	KZL0018
20	14	KZL0020
22	18	KZL0022
28	24	NEW KZL0028

Espiga lisa métrica 90°

Welding metric standpipe 90°

Embout lisse métrique 90° à souder

Estremità tubolare metrica a 90°



Ø EXT. Ø OUTER	Ø INT. Ø INNER	Referencia Part n°
6	4	KZC9006
8	4	KZC9008
10	6	KZC9010
12	8	KZC9012
15	11	KZC9015
18	14	KZC9018
20	12	KZC9020
22	18	KZC9022

Espiga lisa métrica 45°

Welding metric standpipe 45°

Embout lisse métrique 45° à souder

Estremità tubolare metrica a 45°



Ø EXT. Ø OUTER	Ø INT. Ø INNER	Referencia Part n°
6	4	KZC4506
8	4	KZC4508
10	6	KZC4510
12	8	KZC4512
14	10	KZC4514
15	11	KZC4515
16	11	KZC4516
18	14	KZC4518
20	12	KZC4520
22	18	KZC4522

Racores soldables

Welding fittings
Embouts à souder
Raccordi a saldare

Hembra giratoria 90º soldable métrica

Weldable metrical swivel female 90º

Femelle tournante 90º métrique à souder

Femmina girevole 90º metrica a saldare



TUBO PIPE	ROSCA THREAD	Referencia Part nº
10	M16X1,5	Z10521610
12	M18X1,5	Z10521812
12	M20X1,5	Z10522012
15	M22X1,5	Z10522215
18	M26X1,5	Z10522618
20	M30X2	Z10523020
22	M30X2	Z10523022
28	M36X2	Z10523628
42	M52X2	Z10525242

Hasta fin de existencias / Until end of stock / Jusqu'à la fin du stock / Fino ad esaurimento

Hembra giratoria 90º soldable métrica sin junta

Weldable metrical swivel female 90º without o´ring

Femelle tournante 90º métrique à souder sans joint

Femmina girevole 90º metrica a saldare senza O´ring



TUBO PIPE	ROSCA THREAD	Referencia Part nº
6	M12X1,5	Z10541206
8	M14X1,5	Z10541408
10	M16X1,5	Z10541610
12	M18X1,5	Z10541812
15	M22X1,5	Z10542215
18	M26X1,5	Z10542618
22	M30X2	Z10543022
28	M36X2	Z10543628
35	M45X2	Z10544535
42	M52X2	Z10545242
6	M14X1,5	Z10541406
8	M16X1,5	Z10541608
10	M18X1,5	Z10541810
12	M20X1,5	Z10542012
14	M22X1,5	Z10542214
16	M24X1,5	Z10542416
20	M30X2	Z10543020
25	M36X2	Z10543625
30	M42X2	Z10544230
38	M52X2	Z10545238

Hembra giratoria 45º soldable métrica

Weldable metrical swivel female 45º

Femelle tournante 45º métrique à souder

Femmina girevole 45º metrica a saldare



TUBO PIPE	ROSCA THREAD	Referencia Part nº
10	M16X1,5	Z10531610
12	M18X1,5	Z10531812
15	M22X1,5	Z10532215
22	M30X2	Z10533022
28	M36X2	Z10533628
42	M52X2	Z10535242
20	M30X2	Z10533020

Hasta fin de existencias / Until end of stock / Jusqu'à la fin du stock / Fino ad esaurimento

Hembra giratoria 45º soldable métrica sin junta

Weldable metrical swivel female 45º without o´ring

Femelle tournante 45º métrique à souder sans joint

Femmina girevole 45º metrica a saldare senza O´ring



TUBO PIPE	ROSCA THREAD	Referencia Part nº
6	M12X1,5	Z10551206
8	M14X1,5	Z10551408
10	M16X1,5	Z10551610
12	M18X1,5	Z10551812
15	M22X1,5	Z10552215
18	M26X1,5	Z10552618
22	M30X2	Z10553022
28	M36X2	Z10553628
35	M45X2	Z10554535
42	M52X2	Z10555242
6	M14X1,5	Z10551406
8	M16X1,5	Z10551608
10	M18X1,5	Z10551810
12	M20X1,5	Z10552012
14	M22X1,5	Z10552214
16	M24X1,5	Z10552416
20	M30X2	Z10553020
25	M36X2	Z10553625
30	M42X2	Z10554230
38	M52X2	Z10555238

Macho soldable Métrico

Welding DIN Male

Male métrique à souder

Maschio metrico sede 24º a saldare



TUBO PIPE	SERIE	Referencia Part nº
6	L	Z1050L06
8	L	Z1050L08
10	L	Z1050L10
12	L	Z1050L12
15	L	Z1050L15
18	L	Z1050L18
22	L	Z1050L22
28	L	Z1050L28
35	L	Z1050L35
42	L	Z1050L42
6	S	Z1050S06
8	S	Z1050S08
10	S	Z1050S10
12	S	Z1050S12
14	S	Z1050S14
16	S	Z1050S16
20	S	Z1050S20
25	S	Z1050S25
30	S	Z1050S30
38	S	Z1050S38

CRIMPING FITTINGS
FOR HOSES

PIPE
FITTINGS

PIPE
FITTINGS II

ADAPTORS

WELDING
FITTINGS

INDUSTRIAL
FITTINGS

ACCESSORIES

CONTROL
COMPONENTS

FLOW
MEASURING

TRAILER LOK

Racores soldables

Welding fittings
Embouts à souder
Raccordi a saldare

Tuercas BSP Microfundido AISI-316

Micro-casting BSP nuts AISI-316

Écrous BSP en acier moulé AISI-316

Dadi BSP microfusi AISI-316



ROSCA THREAD	Referencia Part n°
2" 1/2 BSP	Z127040
3" BSP	Z127048
4" BSP	Z127064

Macho BSPT soldar microfundido AISI-316

Micro-casting BSPT welding male AISI-316

Mâle BSPT à souder en acier moulé AISI-316

Maschio BSPT a saldare microfuso AISI-316



DN	ROSCA THREAD	Referencia Part n°
2"1/2	2"1/2 BSPT	ZM103240
3"	3" BSPT	ZM103248
4"	4" BSPT	ZM103264

Cono ajuste BSP 60° con guía

Welding nipple with 60° cone for BSP nut with guide

Collet à souder BSP cône 60° avec guide

Ogiva a saldare cono 60° con guida per dado BSP



DN	ROSCA THREAD	Referencia Part n°
2"1/2	2"1/2 BSP	Z127840
3"	3" BSP	Z127848
4"	4" BSP	Z127864

Racores soldables

Welding fittings
Embouts à souder
Raccordi a saldare

Tuerca cono ajuste BSP

BSP Nut for welding 60° cone nipple

Écrou gaz pour collet à souder

Dado BSP per ogiva a saldare cono 60°



ROSCA THREAD	Referencia Part n°
1/4" BSP	Z127004
3/8" BSP	Z127006
1/2" BSP	Z127008
3/4" BSP	Z127012
1" BSP	Z127016
1"1/4 BSP	Z127020
1"1/2 BSP	Z127024
2" BSP	Z127032

Cono ajuste BSP 60°

Welding nipple BSP 60°

Collet à souder BSP cône 60°

Ogiva a saldare BSP



ROSCA THREAD	Referencia Part n°
1/4" BSP	Z127304
3/8" BSP	Z127306
1/2" BSP	Z127308
3/4" BSP	Z127312
1" BSP	Z127316
1"1/4 BSP	Z127320
1"1/2 BSP	Z127324
2" BSP	Z127332

Cono ajuste BSP asiento plano

Welding nipple BSP flat seat

Collet à souder BSP fond plat

Ogiva a saldare sede piana



ROSCA THREAD	Ø EXT. Ø OUTER	Referencia Part n°
1"1/4 BSP	33	Z127420
1"1/4 BSP	33	Z127920

Hasta fin de existencias / Until end of stock / Jusqu'à la fin du stock / Fino ad esaurimento

Z127920 con guía. / Z127920 with guide / Z127920 avec guide. / Z127920 con guida

Cono ajuste JIC 37° con guía

Welding nipple for JIC 37° with guide

Collet à souder femelle JIC cône 37° avec guide

Ogiva a saldare cono JIC 37° con guida



ROSCA THREAD	DN	Referencia Part n°
7/16" 20h UNF	1/4"	Z12770704
1/2" 20h UNF	1/4"	Z12770804
9/16" 18h UNF	3/8"	Z12770906
3/4" 16h UNF	3/8"	Z12771206
7/8" 14h UNF	5/8"	Z12771410
1"1/16 12h UN	3/4"	Z12771712

Hasta fin de existencias / Until end of stock / Jusqu'à la fin du stock / Fino ad esaurimento

Tuercas JIC

JIC nut

Écrou JIC

Dado JIC



TUBO PIPE	ROSCA THREAD	Referencia Part n°	€
6	1/4"	7/16" 20h UNF	ZS11006 *
8	5/16"	1/2" 20h UNF	ZS11008 *
10	3/8"	9/16" 18h UNF	ZS11010 *
12	1/2"	3/4" 16h UNF	ZS11012 *
14-15-16	5/8"	7/8" 14h UNF	ZS11016 *
18-20	-	1"1/16 12h UN	ZS11020 *
-	3/4"	1"1/16 12h UNF	ZS11020W *
25	1"	1"5/16 12h UN	ZS11025 *
30-32	1 1/4"	1"5/8 12h UN	ZS11032 *
38	1 1/2"	1"7/8 12h UN	ZS11038 *

*Ver precios en p.125 (R. JIC) / *See prices in p.125 (JIC Fittings) / *Prix à la page 125 (R. JIC) / *Vedere prezzi p.125 (R. JIC)

Racores soldables

Welding fittings
Embouts à souder
Raccordi a saldare

Unión 3 piezas hembra-soldar FIG.340HS microfundido

Union 3 fem. welding pieces fig.340hs micro-casting

Union 3 pcs fem. à souder fig.340hs inox acier moulé

Unione a 3 pezzi f.saldare fig.340hs inox microfusione



ROSCA THREAD	Referencia Part n°	€
1/4"	ZFIG34004HS	*
3/8"	ZFIG34006HS	*
1/2"	ZFIG34008HS	*
3/4"	ZFIG34012HS	*
1"	ZFIG34016HS	*
1" 1/4	ZFIG34020HS	*
1" 1/2	ZFIG34024HS	*
2"	ZFIG34032HS	*

*Ver precios en p.232 / *See prices p.232 / *Voir prix p.232 / *Vedere prezzi p.232

Unión 3 piezas macho-soldar FIG.341MS microfundido

Union 3 welding male pieces fig.341ms micro-casting

Union 3 pcs mâle à souder fig.341ms inox acier moulé

Unione a 3 pezzi m.saldare fig.341ms inox microfusione



ROSCA THREAD	Referencia Part n°	€
1/4"	ZFIG34104MS	*
3/8"	ZFIG34106MS	*
1/2"	ZFIG34108MS	*
3/4"	ZFIG34112MS	*
1"	ZFIG34116MS	*
1" 1/4	ZFIG34120MS	*
1" 1/2	ZFIG34124MS	*
2"	ZFIG34132MS	*

*Ver precios en p.232 / *See prices p.232 / *Voir prix p.232 / *Vedere prezzi p.232

Unión 3 piezas soldar FIG.340S microfundido

Union 3 welding pieces fig. 340s micro-casting

Union 3 pièces à souder fig. 340s inox acier moulé

Unione a 3 pezzi a saldare fig.340s inox microfusione



ROSCA THREAD	Referencia Part n°	€
1/4"	ZFIG34004S	*
3/8"	ZFIG34006S	*
1/2"	ZFIG34008S	*
3/4"	ZFIG34012S	*
1"	ZFIG34016S	*
1" 1/4	ZFIG34020S	*
1" 1/2	ZFIG34024S	*
2"	ZFIG34032S	*

*Ver precios en p.232 / *See prices p.232 / *Voir prix p.232 / *Vedere prezzi p.232

Bridas soldables

Welding flanges
Brides à souder
Flangia a saldare

Brida fija soldable PN10/16 DIN 2633

Welding forged flange DIN 2633 PN 10/16

Bride fixe à souder DIN 2633 PN10/16

Flangia forgiata a saldare DIN 2633 PN 10/16



DN	Referencia Part n°
15-1/2"	ZBPN16263308
20-3/4"	ZBPN16263312
25-1"	ZBPN16263316
32-1"1/4	ZBPN16263320
40-1"1/2	ZBPN16263324
50-2"	ZBPN16263332
65-2"1/2	ZBPN16263340
80-3"	ZBPN16263348
100-4"	ZBPN16263364

Brida fija soldable PN40 DIN 2635

Welding forged flange DIN 2635 PN 40

Bride fixe à souder DIN 2635 PN 40

Flangia forgiata a saldare DIN 2635 PN 40



DN	Referencia Part n°
13-3/8"	ZBPN40263506*
15-1/2"	ZBPN40263508
20-3/4"	ZBPN40263512
25-1"	ZBPN40263516
32-1"1/4	ZBPN40263520
40-1"1/2	ZBPN40263524
50-2"	ZBPN40263532
65-2"1/2	ZBPN40263540
80-3"	ZBPN40263548
100-4"	ZBPN40263564

*Hasta fin de existencias / Until end of stock / Jusqu'à la fin du stock / Fino ad esauri

Brida fija ANSI-ASA 150 LBS

Flange ANSI-ASA Welding Neck 150 LBS

Bride ANSI-ASA Welding Neck 150 LBS

Flangia ANSI-ASA a saldare 150 LBS



DN	Referencia Part n°
15-1/2"	ZBANSAWN15008
20-3/4"	ZBANSAWN15012
25-1"	ZBANSAWN15016
32-1"1/4	ZBANSAWN15020
40-1"1/2	ZBANSAWN15024
50-2"	ZBANSAWN15032
65-2"1/2	ZBANSAWN15040
80-3"	ZBANSAWN15048
100-4"	ZBANSAWN15064

Brida fija ANSI-ASA 350 LBS

FLANGE ANSI-ASA Welding Neck 300 LBS

Bride ANSI-ASA Welding Neck 300 LBS

Flangia ANSI-ASA a saldare 300 LBS



DN	Referencia Part n°
15-1/2"	ZBANSAWN30008
20-3/4"	ZBANSAWN30012
25-1"	ZBANSAWN30016
32-1"1/4	ZBANSAWN30020
40-1"1/2	ZBANSAWN30024
50-2"	ZBANSAWN30032
65-2"1/2	ZBANSAWN30040
80-3"	ZBANSAWN30048
100-4"	ZBANSAWN30064

CRIMPING FITTINGS
FOR HOSES

PIPE
FITTINGS

PIPE
FITTINGS II

ADAPTORS

WELDING
FITTINGS

INDUSTRIAL
FITTINGS

ACCESSORIES

CONTROL
COMPONENTS

FLOW
MEASURING

TRALE LOK

Bridas soldables

Welding flanges
Brides à souder
Flangia a saldare

Brida loca PN10 DIN 2642

Welding forged slip on flange DIN 2642 PN 10

Bride tournante à souder DIN 2642 PN 10

Flangia girevole a saldare DIN 2642 PN 10



Tubo para soldar bridas ANSI-DIN

Tube for welding flanges ANSI-DIN

Tube à souder brides ANSI-DIN

Tubo per flangia a saldare ANSI-DIN



DN	Referencia Part n°
15-1/2"	ZBPN10264208
20-3/4"	ZBPN10264212
25-1"	ZBPN10264216
32-1 1/4"	ZBPN10264220
40-1 1/2"	ZBPN10264224
50-2"	ZBPN10264232
65-2 1/2"	ZBPN10264240
80-3"	ZBPN10264248
100-4"	ZBPN10264264

DN	Referencia Part n°
3/8"	ZBTUBO06
1/2"	ZBTUBO08
3/4"	ZBTUBO12
1"	ZBTUBO16
1 1/4"	ZBTUBO20
1 1/2"	ZBTUBO24
2"	ZBTUBO32
2 1/2"	ZBTUBO40
3"	ZBTUBO48
4"	ZBTUBO64

Aro para brida DIN 2642

Ring for flange DIN 2642

Collet épais pour bride DIN 2642

Anello per flangia DIN 2642



DN	Referencia Part n°
1 1/2"	ZABARO264208
3/4"	ZABARO264212
1"	ZABARO264216
1 1/4"	ZABARO264220
1 1/2"	ZABARO264224
2"	ZABARO264232
2 1/2"	ZABARO264240
3"	ZABARO264248
4"	ZABARO264264

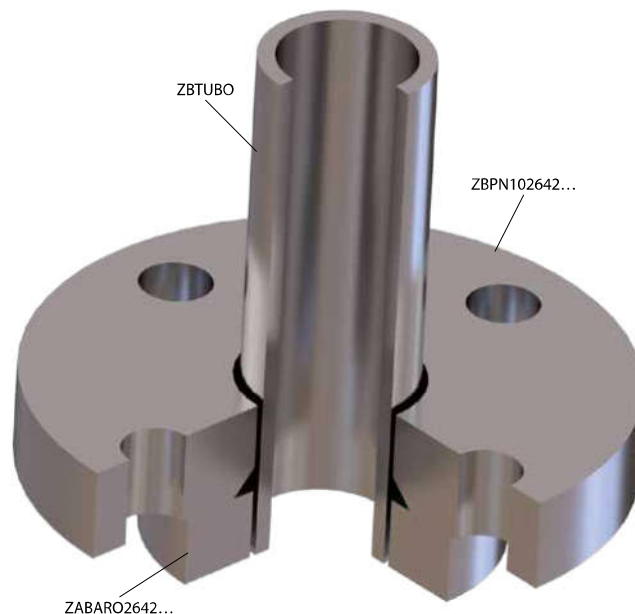

Bridas soldables

Welding flanges
Brides à souder
Flangia a saldare

Brida plana PN40 DIN 2656

Welding forged flange DIN 2656 PN 40

Bride tournante à souder DIN 2656 PN 40

Flangia girevole a saldare DIN 2656 PN 40



DN	Referencia Part n°
15-1/2"	ZBPN40265608
20-3/4"	ZBPN40265612
25-1"	ZBPN40265616
32-1"1/4	ZBPN40265620
40-1"1/2	ZBPN40265624
50-2"	ZBPN40265632
65-2"1/2	ZBPN40265640
80-3"	ZBPN40265648
100-4"	ZBPN40265664

Aro para brida DIN 2656

Ring for flange DIN 2656

Collet épais pour bride DIN 2656

Anello per flangia DIN 2656



DN	Referencia Part n°
1/2"	ZABARO265608
3/4"	ZABARO265612
1"	ZABARO265616
1"1/4	ZABARO265620
1"1/2	ZABARO265624
2"	ZABARO265632
2"1/2	ZABARO265640
3"	ZABARO265648

Tubo para soldar bridas ANSI-DIN

Tube for welding flanges ANSI-DIN

Tube à souder brides ANSI-DIN

Tubo per flangia a saldare ANSI-DIN



DN	Referencia Part n°
3/8"	ZBTUBO06
1/2"	ZBTUBO08
3/4"	ZBTUBO12
1"	ZBTUBO16
1"1/4	ZBTUBO20
1"1/2	ZBTUBO24
2"	ZBTUBO32
2"1/2	ZBTUBO40
3"	ZBTUBO48
4"	ZBTUBO64

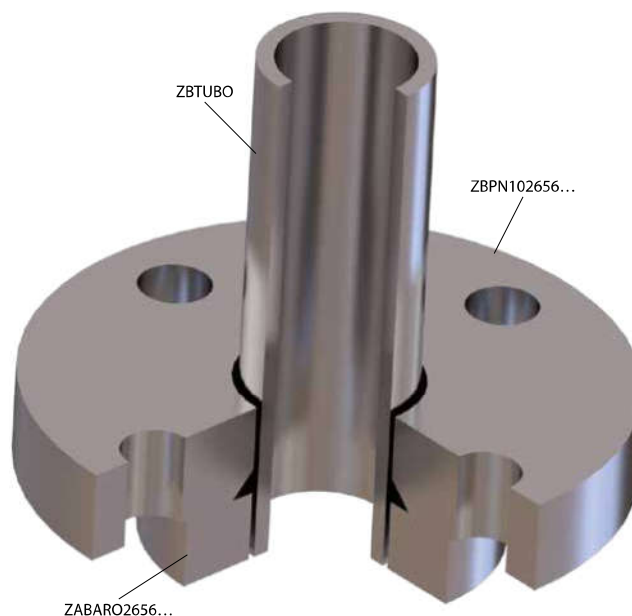

CRIMPING FITTINGS
FOR HOSES

PIPE
FITTINGS

PIPE
FITTINGS II

ADAPTORS

WELDING
FITTINGS

INDUSTRIAL
FITTINGS

ACCESSORIES

CONTROL
COMPONENTS

FLOW
MEASURING

TRALE LOK

CRIMPING FITTINGS
FOR HOSES

PIPE
FITTINGS

PIPE
FITTINGS II

ADAPTORS

WELDING
FITTINGS

INDUSTRIAL
FITTINGS

ACCESSORIES

CONTROL
COMPONENTS

FLOW
MEASURING

TRAILER LOK

Bridas soldables

Welding flanges
Brides à souder
Flangia a saldare

Brida plana ANSI-ASA 150 LBS

Swivel flange ANSI-ASA 150 LBS

Bride tournante ANSI-ASA 150 LBS

Flangia girevole ANSI-ASA 150 LBS



DN	Referencia Part n°
15-1/2"	ZBANSASO15008
20-3/4"	ZBANSASO15012
25-1"	ZBANSASO15016
32-1"1/4	ZBANSASO15020
40-1"1/2	ZBANSASO15024
50-2"	ZBANSASO15032
65-2"1/2	ZBANSASO15040
80-3"	ZBANSASO15048
100-4"	ZBANSASO15064

Brida plana ANSI-ASA 300 LBS

Swivel flange ANSI-ASA 300 LBS

Bride tournante ANSI-ASA 300 LBS

Flangia girevole ANSI-ASA 300 LBS



DN	Referencia Part n°
15-1/2"	ZBANSASO30008
20-3/4"	ZBANSASO30012
25-1"	ZBANSASO30016
32-1"1/4	ZBANSASO30020
40-1"1/2	ZBANSASO30024
50-2"	ZBANSASO30032
65-2"1/2	ZBANSASO30040
80-3"	ZBANSASO30048
100-4"	ZBANSASO30064

Aro para brida ANSI-ASA

Ring for flange ANSI-ASA

Collet épais pour bride ANSI-ASA

Anello per flangia ANSI-ASA



DN	Referencia Part n°
1/2"	ZABAROANSA08
3/4"	ZABAROANSA12
1"	ZABAROANSA16
1"1/4	ZABAROANSA20
1"1/2	ZABAROANSA24
2"	ZABAROANSA32
2"1/2	ZABAROANSA40
3"	ZABAROANSA48
4"	ZABAROANSA64

Tubo para soldar bridas ANSI-DIN

Tube for welding flanges ANSI-DIN

Tube à souder brides ANSI-DIN

Tubo per flangia a saldare ANSI-DIN



DN	Referencia Part n°
3/8"	ZBTUBO06
1/2"	ZBTUBO08
3/4"	ZBTUBO12
1"	ZBTUBO16
1"1/4	ZBTUBO20
1"1/2	ZBTUBO24
2"	ZBTUBO32
2"1/2	ZBTUBO40
3"	ZBTUBO48
4"	ZBTUBO64

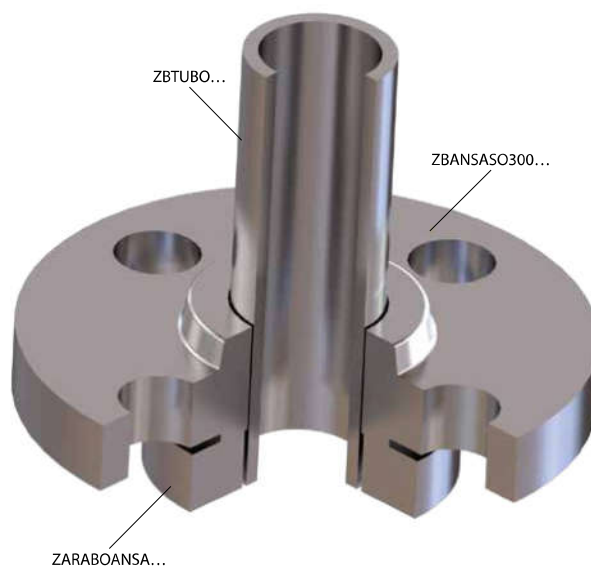
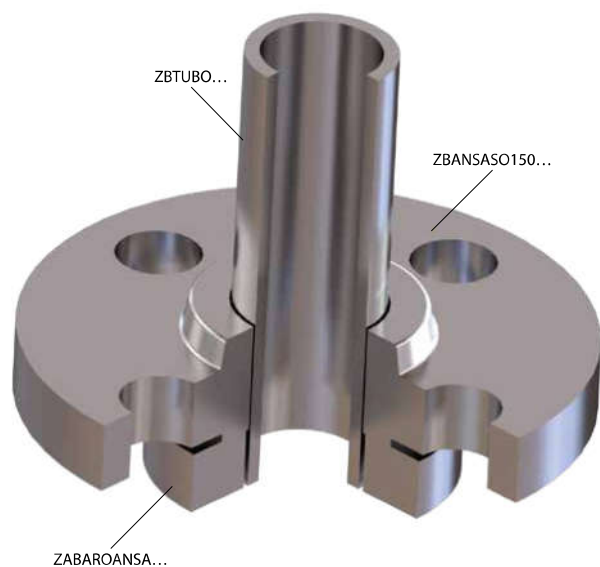

Racores industria alimentaria 213

Food industry fittings
Raccords alimentaires
Raccordi alimentari

Serie Camlock DIN 2828 221

DIN 2828 Camlock Fittings
Raccords Camlock DIN 2828
Camlock DIN 2828

Acoples GUILLEMIN NF E-29572 225

GUILLEMIN NF E-29572 Fittings
Raccords GUILLEMIN NF E-29572
Raccordi GUILLEMIN NF E-29572

Acoples TW (Tankwagen) DIN 28450 227

TW (Tankwagen) DIN 28450 Fittings
Raccords TW (Tankwagen) DIN 28450
Raccordi TW (Tankwagen) DIN 28450

**Accesorios inox para
racor industrial 228**

Stainless Steel accessories for industrial fitting
Accessoires acier inox pour raccord industriel
Accessori in acciaio inossidabile per raccordo industriale

Racores baja presión 150 LBS 229

Screw low pressure fittings 150 LBS
Raccords basse pression 150 LBS
Raccordi bassa pressione 150 LBS



06

RACORES INDUSTRIALES

Industrial fittings

Raccords industriels

Raccordi industriali

CRIMPING FITTINGS
FOR HOSES

Racores industria alimentaria

Food industry fittings
Raccords alimentaires
Raccordi alimentari

PIPE
FITTINGS

Casquillos para prensar ▪ Crimping ferrules ▪ Jupes à sertir ▪ Boccole a pressare

213



81042

PIPE
FITTINGS II

Racores SMS ▪ SMS Unions ▪ Raccords SMS ▪ Raccordi SMS

214



ZRA200



ZRA212



ZSMS H



ZSMS S



ZSMS M



Z SMS BN



JSMSS



JSMSP

ADAPTORS

Racores Tri-Clamp ▪ Clamp Unions ▪ Raccords Tri-Clamp ▪ Raccordi Tri-Clamp

216



ZTC



ZC



JCLAMPS



JCLAMPP



ZAC1P



ZPC

WELDING
FITTINGS

Racores DIN 11851 ▪ DIN 11851 Unions ▪ Raccords DIN 11851 ▪ Raccordi DIN 11851

217



ZRA100



ZRA112



ZDIN H



Z DIN BN



ZDIN S



ZDIN M



JDINS



JDINP

INDUSTRIAL
FITTINGS

Racores Macon ▪ Macon Unions ▪ Raccords Macon ▪ Raccordi Macon

218



ZRA300



ZRA312



ZMAC H

ACCESSORIES

Racores alimentarios para manguera PTFE Serie STD ▪ Food industry fittings for PTFE hose STD Series ▪ Raccords alimentaires pour tuyau PTFE Série STD ▪ Raccordi alimentari per tubo PTFE Serie STD

219



ZRA250



ZRA150



ZRA252



ZRA152



ZTCS



81040



81041

CONTROL
COMPONENTS

Racores RJT ▪ RJT Fittings ▪ Raccords RJT ▪ Raccordi RJT

220



ZRJT H



ZRJT M



ZRJT WL



JRJT NBR

FLOW
MEASURING

TRALE LOK

Serie Camlock DIN 2828

DIN 2828 Camlock Fittings
Raccords Camlock DIN 2828
Camlock DIN 2828

Racores Camlock AISI 316 ▪ Camlock Unions AISI 316 ▪ Raccords Camlock AISI 316 ▪ Raccordi Camlock AISI 316 | 221



Serie Autolock AISI 316

Autolock Unions AISI 316
Raccords Autolock AISI 316
Raccordi Autolock AISI 316

Racores Autolock AISI 316 ▪ Autolock Unions AISI 316 ▪ Raccords Autolock AISI 316 ▪ Raccordi Autolock AISI 316 | 224



Acoples GUILLEMIN NF E-29572

GUILLEMIN NF E-29572 Fittings
Raccords GUILLEMIN NF E-29572
Raccordi GUILLEMIN NF E-29572

GUILLEMIN inox ▪ GUILLEMIN Stainless Steel ▪ GUILLEMIN acier inox ▪ GUILLEMIN acciaio inossidabile | 225



Acoples TW (Tankwagen) DIN 28450

TW (Tankwagen) DIN 28450 Fittings
Raccords TW (Tankwagen) DIN 28450
Raccordi TW (Tankwagen) DIN 28450

TW (Tankwagen) inox ▪ TW Stainless Steel ▪ TW acier inox ▪ TW Acciaio Inossidabile | 227



CRIMPING FITTINGS
FOR HOSES

PIPE
FITTINGS

PIPE
FITTINGS II

ADAPTORS

WELDING
FITTINGS

INDUSTRIAL
FITTINGS

ACCESSORIES

CONTROL
COMPONENTS

FLOW
MEASURING

TRALE LOK

Accesorios inox para racor industrial

Stainless Steel accessories for industrial fitting
Accessoires acier inox pour raccord industriel
Accessori in acciaio inossidabile per raccordo industriale

Campana inox para racor industrial ▪ Stainless Steel Crimping Ferrule for industrial fitting ▪ Jupe pour raccord industriel acier inox ▪ Boccola in acciaio inossidabile per raccordo industriale

228



ZCA

Abrazadera inox para racor industrial ▪ Stainless Steel clamp for industrial fitting ▪ Collier pour raccord industriel acier inox ▪ Collare in acciaio inossidabile per raccordo industriale

228



ZAB01



ZAB02

Racores baja presión 150 LBS

Screw low pressure fittings 150 LBS
Raccords basse pression 150 LBS
Raccordi bassa pressione 150 LBS

150 LBS Microfundido ▪ Screwed fittings low pressure 150 LBS ▪ Adapteurs basse pression 150 LBS ▪ Raccordi bassa pressione

229



ZFIG399

ZFIG150

ZFIG290

ZFIG280

ZFIG245

ZFIG312

ZFIG300

ZFIG270

ZFIG291

ZFIG301

ZFIG241

ZFIG531

ZFIG240

ZFIG090

ZFIG120

ZFIG092

ZFIG130

ZFIG180

ZFIG340

ZFIG341

ZFIG149

150 LBS Soldables ▪ Welding fittings low pressure 150 LBS ▪ Raccords à souder basse pression 150 LBS ▪ Raccordi bassa pressione per saldare 150 LBS

232



ZFIG340...HS



ZFIG340...S



ZFIG341...MS

150 LBS Válvulas ▪ 150 LBS fittings Valves ▪ Raccords Vannes 150 LBS ▪ Raccordi Valvole 150 LBS

233



BP2V3P



BP2V

Racores industria alimentaria

Food industry fittings
Raccords alimentaires
Raccordi alimentari

Casquillos para mangueras alimentarias

Food industry hoses ferrules

Jupes à sertir tuyaux alimentaires

Boccola a pressare per tubi alimentari



DN	Ø MANGUERA Ø HOSE	Referencia Part n°
13-1/2"	23	810421324
19-3/4"	32	810421933
25-1"	39	810422540
32-1"1/4	48	810423248
38-1"1/2	52	810423852
38-1"1/2	56	810423857
40-1"1/2	54	810424055
40-1"1/2	60	810424061
50-2"	63	810425064
50-2"	68	810425069
50-2"	73	810425073
65-2"1/2	79	810426580
65-2"1/2	93	810426593
70-3"	89	810427090
75-3"	94	810427595
75-3"	106	8104275107
100-4"	122	81042100123
100-4"	134	81042100135



FOOD INDUSTRY HOSES | MANGUERAS ALIMENTARIAS



Hoses suitable for suction and discharge:
Milk, wine, oils, fatty foods, alcohol drinks (max 40%), etc. /

Mangueras aptas para productos alimentarios de aspiración e impulsión:

Leche, vino, aceites, alimentos grasos, bebidas alcohol (máx. 40%), etc.

Ver precios en Catálogo Conducciones. | See prices in Connectors Catalogue.



CRIMPING FITTINGS
FOR HOSES

PIPE
FITTINGS

PIPE
FITTINGS II

ADAPTORS

WELDING
FITTINGS

INDUSTRIAL
FITTINGS

ACCESSORIES

CONTROL
COMPONENTS

FLOW
MEASURING

TRALE LOK

Racores industria alimentaria

Food industry fittings
Raccords alimentaires
Raccordi alimentari

Hembras giratorias SMS

Swivel female SMS

Raccord femelle tournante SMS

Femmina girevole SMS



ROSCA THREAD	DN	Referencia Part n°
40x1/6"	25	ZRA2004025
48x1/6"	32	ZRA2004832
60x1/6"	38	ZRA2006038
60x1/6"	40	ZRA2006040
70x1/6"	50	ZRA2007050
85x1/6"	63	ZRA2008563
85x1/6"	65	ZRA2008565
98x1/6"	70	ZRA2009870
98x1/6"	75	ZRA2009875
98x1/6"	80	ZRA2009880
125x1/4"	100	ZRA200125100
132x1/4"	100	ZRA200132100

Machos fijos SMS

Fixed male SMS

Raccord mâle SMS

Maschio fisso SMS



ROSCA THREAD	DN	Referencia Part n°
40x1/6"	25	ZRA2124025
48x1/6"	32	ZRA2124832
60x1/6"	38	ZRA2126038
60x1/6"	40	ZRA2126040
70x1/6"	50	ZRA2127050
85x1/6"	63	ZRA2128563
85x1/6"	65	ZRA2128565
98x1/6"	70	ZRA2129870
98x1/6"	75	ZRA2129875
98x1/6"	80	ZRA2129880
125x1/4"	100	ZRA212125100
132x1/4"	100	ZRA212132100

Tuercas SMS

Nuts SMS

Écrou SMS

Dadi SMS



ROSCA THREAD	DN	Referencia Part n°
40x1/6"	25	ZSMS H 25
48x1/6"	32	ZSMS H 32
60x1/6"	38	ZSMS H 38
70x1/6"	51	ZSMS H 51
85x1/6"	63	ZSMS H 63
98x1/6"	76	ZSMS H 76
125x1/4"	104	ZSMS H 104
132x1/4"	104	ZSMS H 105

Conos soldables SMS

Liner to weld SMS

Douilles à souder SMS

Sede a saldare per femmina SMS



DN	Referencia Part n°
25	ZSMS S 25
32	ZSMS S 32
38	ZSMS S 38
51	ZSMS S 51
63	ZSMS S 63
76	ZSMS S 76
104	ZSMS S 104

Machos soldables SMS

Weld male SMS

Nez à souder SMS

Maschio a saldare SMS



ROSCA THREAD	DN	Referencia Part n°
40x1/6"	25	ZSMS M 25
48x1/6"	32	ZSMS M 32
60x1/6"	38	ZSMS M 38
70x1/6"	51	ZSMS M 51
85x1/6"	63	ZSMS M 63
98x1/6"	76	ZSMS M 76
125x1/4"	104	ZSMS M 104

Racores industria alimentaria

Food industry fittings
Raccords alimentaires
Raccordi alimentari

Tapones SMS

Blind round nut SMS

Ecrou Bouchon Avec Chainette

Dado tondo cieco SMS



DN	ROSCA THREAD	Referencia Part n°
25	40X1/6"	Z SMS BN 25
38	60X1/6"	Z SMS BN 38
51	70X1/6"	Z SMS BN 51
63	85X1/6"	Z SMS BN 63
76	98X1/6"	Z SMS BN 76
104	125X1/4"	Z SMS BN 104

Junta SMS silicona

Silicone joint for SMS

Joint silicône pour SMS

Guarnizione in silicone per SMS



DN	Referencia Part n°
25	JSMSS 25
32	JSMSS 32
38	JSMSS 38
51	JSMSS 51
63	JSMSS 63
76	JSMSS 76
104	JSMSS 104

Juntas SMS PTFE

PTFE Joint for SMS

Joint PTFE pour SMS

Guarnizione in PTFE per SMS



DN	Referencia Part n°
25	JSMSP 25
32	JSMSP 32
38	JSMSP 38
51	JSMSP 51
63	JSMSP 63
76	JSMSP 76

CRIMPING FITTINGS
FOR HOSES

PIPE
FITTINGS

PIPE
FITTINGS II

ADAPTORS

WELDING
FITTINGS

INDUSTRIAL
FITTINGS

ACCESSORIES

CONTROL
COMPONENTS

FLOW
MEASURING

TRALE LOK

CRIMPING FITTINGS
FOR HOSES

PIPE
FITTINGS

PIPE
FITTINGS II

ADAPTORS

WELDING
FITTINGS

INDUSTRIAL
FITTINGS

ACCESSORIES

CONTROL
COMPONENTS

FLOW
MEASURING

TRALE LOK

Racores industria alimentaria

Food industry fittings
Raccords alimentaires
Raccordi alimentari

Tri-Clamp ISO 2852

Tri-Clamp ISO 2852

Raccord Tri-Clamp ISO 2852

Tri-Clamp ISO 2852 per tubo flessibile



∅	DN	Referencia Part n°
25	12	ZTC2512
25	19	NEW ZTC2519
34	12	ZTC3412
34	19	ZTC3419
50,5	19	ZTC5019
50,5	25	ZTC5025
50,5	32	ZTC5032
50,5	38	ZTC5038
50,5	40	ZTC5040
64	38	ZTC6438
64	40	ZTC6440
64	50	ZTC6450
77,5	50	ZTC7750
77,5	65	ZTC7763
91	65	ZTC9165
91	75	ZTC9175

Tri-Clamp para soldar en tubo

Welding Tri-Clamp for pipe

Raccord Tri-Clamp à souder pour tube

Tri-Clamp a saldare per tubo rigido



∅	DN	Referencia Part n°
25	12	ZC25-12
34	12	ZC34-12
34	18	ZC34-18
50,5	18	ZC50-18
50,5	25	ZC50-25
50,5	33,7	ZC50-33,7
50,5	38	ZC50-38
64	38	ZC64-38
64	51	ZC64-51
91	65	ZC91-65

Juntas para Clamp Silicona

Joint for silicone clamp

Joint pour clamp silicône

Guarnizione per clamp Silicone



∅	Referencia Part n°
25	JCLAMPS 25
34	JCLAMPS 34
50	JCLAMPS 50
64	JCLAMPS 64
77	JCLAMPS 77
91	JCLAMPS 91

Juntas para Clamp PTFE

Joint for PTFE clamp

Joint pour clamp PTFE

Guarnizione per clamp PTFE



∅	Referencia Part n°
25	JCLAMPP 25
34	JCLAMPP 34
50	JCLAMPP 50
64	JCLAMPP 64
77	JCLAMPP 77
91	JCLAMPP 91

Abrazaderas Tri-clamp con 1 pin

Tri-Clamp with 1 pin

Collier Tri-Clamp avec 1 pin

Collare Tri-Clam con 1 pim



∅	Referencia Part n°
25	ZAC1P25
34	ZAC1P34
50	ZAC1P50
64	ZAC1P64
77	ZAC1P77
91	ZAC1P91

Tri-Clamp Tapa

Tri-Clamp cover

Tri-Clamp Couverture

Tri-Clamp copertura



∅	Referencia Part n°
25	ZPC25
34	ZPC34
50,5	ZPC50
64	ZPC64
77,5	ZPC77
91	ZPC91

Racores industria alimentaria

Food industry fittings
Raccords alimentaires
Raccordi alimentari

Hembras giratorias DIN 11851

Swivel female DIN 11851

Raccord femelle tournante DIN 11851

Femmina girevole DIN 11851



ROSCA THREAD	DN	Referencia Part n°
44x1/6"	20	ZRA1004420
52x1/6"	25	ZRA1005225
58x1/6"	32	ZRA1005832
65x1/6"	38	ZRA1006538
65x1/6"	40	ZRA1006540
78x1/6"	50	ZRA1007850
95x1/6"	63	ZRA1009563
95x1/6"	65	ZRA1009565
110x1/4"	75	ZRA10011075
110x1/4"	80	ZRA10011080
130x1/4"	100	ZRA100130100

Machos fijos DIN 11851

Fixed male DIN 11851

Raccord mâle DIN 11851

Maschio fisso DIN 11851



ROSCA THREAD	DN	Referencia Part n°
52x1/6"	25	ZRA1125225
58x1/6"	32	ZRA1125832
65x1/6"	38	ZRA1126538
65x1/6"	40	ZRA1126540
78x1/6"	50	ZRA1127850
95x1/6"	63	ZRA1129563
95x1/6"	65	ZRA1129565
110x1/4"	75	ZRA11211075
110x1/4"	80	ZRA11211080
130x1/4"	100	ZRA112130100

Tuercas DIN 11851

Nuts DIN 11851

Écrous DIN 11851

Dado DIN 11851



ROSCA THREAD	DN	Referencia Part n°
34x1/8"	16	ZDIN H 16
44x1/6"	20	ZDIN H 20
52x1/6"	25	ZDIN H 25
58x1/6"	32	ZDIN H 32
65x1/6"	40	ZDIN H 40
78x1/6"	50	ZDIN H 50
95x1/6"	65	ZDIN H 65
110x1/4"	80	ZDIN H 80
130x1/4"	100	ZDIN H 100

Tapones DIN 11851

DIN 11851 Blind round nut

DIN 11851 Ecrou Bouchon Avec Chainette

DIN 11851 Dado tondo cieco



DN	ROSCA	Referencia Part n°
20	44X1/6"	Z DIN BN 20
25	52X1/6"	Z DIN BN 25
32	58X1/6"	Z DIN BN 32
40	65X1/6"	Z DIN BN 40
50	78X1/6"	Z DIN BN 50
65	95X1/6"	Z DIN BN 65
80	110X1/4"	Z DIN BN 80

Conos soldables DIN 11851

Liner to weld DIN 11851

Douilles à souder DIN 11851

Ogiva a saldare per dado DIN 11851



DN	Referencia Part n°
16	ZDIN S 16
20	ZDIN S 20
25	ZDIN S 25
32	ZDIN S 32
40	ZDIN S 40
50	ZDIN S 50
65	ZDIN S 65
75/80	ZDIN S 80
100	ZDIN S 100

Machos soldables DIN 11851

Weld male DIN 11851

Nez à souder DIN 11851

Maschio a saldare DIN 11851



ROSCA THREAD	DN	Referencia Part n°
34x1/8"	16	ZDIN M 16
44x1/6"	20	ZDIN M 20
52x1/6"	25	ZDIN M 25
58x1/6"	32	ZDIN M 32
65x1/6"	40	ZDIN M 40
78x1/6"	50	ZDIN M 50
95x1/6"	65	ZDIN M 65
110x1/4"	75/80	ZDIN M 80
130x1/4"	100	ZDIN M 100

Racores industria alimentaria

Food industry fittings
Raccords alimentaires
Raccordi alimentari

Juntas DIN 11851 silicona

Silicone joint for DIN 11851

Joint silicône pour DIN 11851

Guarnizione in silicone per DIN 11851



DN	Referencia Part n°
20	JDINS 20
25	JDINS 25
32	JDINS 32
40	JDINS 40
50	JDINS 50
65	JDINS 65
80	JDINS 80

Juntas DIN 11851 PTFE

PTFE Joint for DIN 11851

Joint PTFE pour DIN 11851

Guarnizione in PTFE per DIN 11851



DN	Referencia Part n°
20	JDINP 20
25	JDINP 25
32	JDINP 32
40	JDINP 40
50	JDINP 50
65	JDINP 65
80	JDINP 80
100	JDINP 100

Hembras giratorias Macon

Swivel female Macon

Raccord femelle tournante Macon

Femmina girevole Macon



ROSCA THREAD	DN	Referencia Part n°
M55x3	38	ZRA3005538
M55x3	40	ZRA3005540
M67x3	50	ZRA3006750
M79x3,5	65	ZRA3007965
M90x3,5	65	ZRA3009065
M90x3,5	70	ZRA3009070
M90x3,5	80	ZRA3009080
M102x4	80	ZRA30010280

Machos fijos Macon

Male fixe Macon

Raccord mâle fixe Macon

Maschio fisso Macon



ROSCA THREAD	DN	Referencia Part n°
M55x3	38	ZRA3125538
M55x3	40	ZRA3125540
M67x3	50	ZRA3126750
M79x3,5	65	ZRA3127965
M90x3,5	70	ZRA3129070
M90x3,5	80	ZRA3129080
M102x4	80	ZRA31210280

Tuercas Macon

Macon nuts

Écrous à crans Macon

Dadi Macon



ROSCA THREAD	DN	Referencia Part n°
M55x3	40	ZMAC H 40
M67x3	50	ZMAC H 50
M79x3,5	60	ZMAC H 60
M90x3,5	70	ZMAC H 70
M102x4	80	ZMAC H 80
M125x4	100	ZMAC H 100

Racores industria alimentaria

Food industry fittings
Raccords alimentaires
Raccordi alimentari

Hembras giratorias prensar SMS para PTFE Serie STD

Swivel female SMS for PTFE STD Series

Femelle tournante SMS pour PTFE Série STD

Femmina girevole SMS per tubo PTFE Serie STD



ROSCA THREAD	DN	Referencia Part n°
40x1/6"	1"	ZRA2504016
48x1/6"	1" 1/4	ZRA2504820
60x1/6"	1" 1/2	ZRA2506024
70x1/6"	2"	ZRA2507032
85x1/6"	2" 1/2	ZRA2508540

Hembras giratorias DIN 11851 para PTFE Serie ST

Swivel female DIN 11851 for PTFE hose STD Series

Raccord femelle tournante DIN 11851 pour PTFE Série STD

Femmina girevole DIN 11851 per tubo PTFE Serie STD



ROSCA THREAD	DN	Referencia Part n°
52x1/6"	1"	ZRA1505216
58x1/6"	1" 1/4	ZRA1505820
65x1/6"	1" 1/2	ZRA1506524
78x1/6"	2"	ZRA1507832
95x1/6"	2" 1/2	ZRA1509540

Machos SMS para PTFE Serie STD

Fixed male SMS for PTFE hose STD Series

Raccord mâle SMS pour PTFE Série STD

Maschio SMS per tubo PTFE Serie STD



ROSCA THREAD	DN	Referencia Part n°
40x1/6"	1"	ZRA2524016
48x1/6"	1" 1/4	ZRA2524820
60x1/6"	1" 1/2	ZRA2526024
70x1/6"	2"	ZRA2527032
85x1/6"	2" 1/2	ZRA2528540

Machos DIN 11851 para PTFE Serie STD

Fixed male DIN 11851 for PTFE hose STD Series

Raccord mâle DIN 11851 pour PTFE Série STD

Maschio DIN 11851 per tubo PTFE Serie STD



ROSCA THREAD	DN	Referencia Part n°
52x1/6"	1"	ZRA1525216
78x1/6"	2"	ZRA1527832
58x1/6"	1" 1/4	ZRA1525820
65x1/6"	1" 1/2	ZRA1526524
95x1/6"	2" 1/2	ZRA1529540



Racores Tri-Clamp Serie STD

Tri-Clamp Fittings STD Series

Raccords Tri-Clamp Série STD

Raccordi Tri-Clamp Serie STD



∅	DN	Referencia Part n°
34	3/8"	ZTCS3406
50,5	3/4"	ZTCS5012
50,5	1"	ZTCS5016
50,5	1" 1/4	ZTCS5020
50,5	1" 1/2	ZTCS5024
64	1" 1/2	ZTCS6424
64	2"	ZTCS6432
77,5	2"	ZTCS7732

Casquillos PTFE liso

Ferrules for smooth PTFE

Jupes PTFE lisse

Boccole pressare per PTFE liscio



DN	Referencia Part n°	€
1/8"	810400100	*
3/16"	810400300	*
1/4"	810400400	*
5/16"	810400500	*
3/8"	810400600	*
1/2"	810400800	*
5/8"	810401000	*
3/4"	810401200	*
1"	810401600	*

*Ver precios en p.23 / *See prices p.23 / *Voir prix p.23 / *Vedere prezzi p.23

Casquillos PTFE corrugado

Ferrules for convoluted PTFE

Jupes PTFE convoluté

Boccola pressare per PTFE corrugato



DN	Referencia Part n°	€
1/4"	810410400	*
5/16"	810410500	*
3/8"	810410600	*
1/2"	810410800	*
5/8"	810411000	*
3/4"	810411201	*
1"	810411600	*
1"1/4	810412000	*
1"1/2	810412400	*
2"	810413200	*
2"1/2	810414000	*

*Ver precios en p.23 / *See prices p.23 / *Voir prix p.23 / *Vedere prezzi p.23

CRIMPING FITTINGS
FOR HOSES

PIPE
FITTINGS

PIPE
FITTINGS II

ADAPTORS

WELDING
FITTINGS

INDUSTRIAL
FITTINGS

ACCESSORIES

CONTROL
COMPONENTS

FLOW
MEASURING

TRALE LOK

CRIMPING FITTINGS FOR HOSES
PIPE FITTINGS
PIPE FITTINGS II
ADAPTORS
WELDING FITTINGS
INDUSTRIAL FITTINGS
ACCESSORIES
CONTROL COMPONENTS
FLOW MEASURING
TRALE LOK

Racores industria alimentaria

Food industry fittings
Raccords alimentaires
Raccordi alimentari

Tuercas RJT - 304

RJT Nuts - 304

Écrous RJT - 304

Dadi RJT - 304



Welded Liner RJT

Welded Liner RJT

Revêtement soudé RJT

Rivestimento saldato RJT



ROSCA THREAD	DN	Referencia Part n°
42.6X1/8	1"	ZRJT H 25
55.3X1/8	1" 1/2	ZRJT H 38
68.3X1/6	2"	ZRJT H 51
80.9X1/6	2" 1/2	ZRJT H 63
93.6X1/6	3"	ZRJT H 76
119.1X1/6	4"	ZRJT H 102
169.6X1/6	6"	ZRJT H 152

DN	Referencia Part n°
1"	ZRJT WL 25
1" 1/2	ZRJT WL 38
2"	ZRJT WL 51
2" 1/2	ZRJT WL 63
3"	ZRJT WL 76
4"	ZRJT WL 102
6"	ZRJT WL 152

Macho RJT

RJT Male

RJT Mâle

RJT maschio



Junta NBR RJT

NBR RJT Gasket

Joint NBR RJT

Guarnizione NBR RJT



ROSCA THREAD	DN	Referencia Part n°
45.72x8	1"	ZRJT M 25
58.42x8	1" 1/2	ZRJT M 38
72.72x6	2"	ZRJT M 51
85.42x6	2" 1/2	ZRJT M 63
98.12x6	3"	ZRJT M 76
123.52x6	4"	ZRJT M 102
174.32x6	6"	ZRJT M 152

DN	Referencia Part n°
1"	JRJT NBR 25
1" 1/2	JRJT NBR 38
2"	JRJT NBR 51
2" 1/2	JRJT NBR 63
3"	JRJT NBR 76
4"	JRJT NBR 102
6"	JRJT NBR 152

RING JOINT TYPE (RJT)

RENDIMIENTO EXCEPCIONAL EXCEPTIONAL PERFORMANCE

UK'S MOST POPULAR

Industrias Lácteas, Cerveceras, Alimentaria e Industria General
Dairy, Brewery, Food Processing & General Engineering Industries



+ RJT ESPIGA MANGUERA (consultar)
+ RJT HOSE TAIL (on request)

Serie Camlock DIN 2828

DIN 2828 Camlock Fittings
Raccords Camlock DIN 2828
Camlock DIN 2828

Camlock macho - rosca hembra BSP Tipo A

Male Camlock coupling, female BSP threaded Type A

Adapteur mâle Camlock- filetage femelle BSP Type A

Camlock maschio - filetto femmina BSP - TIPO A



DN	ROSCA THREAD	Referencia Part n°
12	1/2"	ZA012
20	1/2"	ZA015
20	3/4"	ZA020
25	1"	ZA025
32	1"1/4	ZA032
40	1"1/2	ZA040
50	2"	ZA050
65	2"1/2	ZA065
80	3"	ZA080
100	4"	ZA100

Camlock hembra - rosca macho BSPT Tipo B

Female Camlock coupling, female BSPT threaded Type B

Adapteur Camlock femelle - filetage mâle BSPT Type B

Camlock femmina - filetto maschio conico BSPT - TIPO B



DN	ROSCA THREAD	Referencia Part n°
12	1/2"	ZB012
20	1/2"	ZB015
20	3/4"	ZB020
25	1"	ZB025
32	1"1/4	ZB032
40	1"1/2	ZB040
50	2"	ZB050
65	2"1/2	ZB065
80	3"	ZB080
100	4"	ZB100

Camlock hembra - para manguera Tipo C

Female Camlock coupling with serrated hose shank Type C

Coupleur Camlock femelle - pour tuyau Type C

Camlock femmina con inserto per tubo - TIPO C



DN	ROSCA THREAD	Referencia Part n°
12	1/2"	ZC012
20	1/2"	ZC015
20	3/4"	ZC020
25	1"	ZC025
32	1"1/4	ZC032
40	1"1/2	ZC040
50	2"	ZC050
65	2"1/2	ZC065
80	3"	ZC080
100	4"	ZC100

Camlock hembra - rosca hembra BSP Tipo D

Female Camlock coupling, female BSP threaded Type D

Adapteur Camlock femelle BSP Type D

Camlock femmina - filetto femmina BSP - TIPO D



DN	ROSCA THREAD	Referencia Part n°
12	1/2"	ZD012
20	1/2"	ZD015
20	3/4"	ZD020
25	1"	ZD025
32	1"1/4	ZD032
40	1"1/2	ZD040
50	2"	ZD050
65	2"1/2	ZD065
80	3"	ZD080
100	4"	ZD100

Camlock macho - para manguera Tipo E

Male Camlock coupling, with serrated hose shank Type E

Coupleur Camlock mâle Type E

Camlock maschio con inserto per tubo - TIPO E



DN	ROSCA THREAD	Referencia Part n°
12	1/2"	ZE012
20	1/2"	ZE015
20	3/4"	ZE020
25	1"	ZE025
32	1"1/4	ZE032
40	1"1/2	ZE040
50	2"	ZE050
65	2"1/2	ZE065
80	3"	ZE080
100	4"	ZE100

Camlock macho - rosca macho BSPT Tipo F

Male Camlock coupling, male BSPT threaded Type F

Adapteur Camlock mâle BSPT Type F

Camlock maschio - filetto maschio conico BSPT - TIPO F



DN	ROSCA THREAD	Referencia Part n°
12	1/2"	ZF012
20	1/2"	ZF015
20	3/4"	ZF020
25	1"	ZF025
32	1"1/4	ZF032
40	1"1/2	ZF040
50	2"	ZF050
65	2"1/2	ZF065
80	3"	ZF080
100	4"	ZF100

Serie Camlock DIN 2828

DIN 2828 Camlock Fittings
Raccords Camlock DIN 2828
Camlock DIN 2828

Camlock hembra - tapón Tipo DC

Female Camlock Coupling-Dust caps Type DC

Bouchon Camlock femelle Type DC

Tappo femmina per maschio Camlock - TIPO DC



DN	Referencia Part n°
12	ZDC012
20	ZDC020
25	ZDC025
32	ZDC032
40	ZDC040
50	ZDC050
65	ZDC065
80	ZDC080
100	ZDC100

Camlock macho - tapón tipo DP

Male Camlock coupling-Dust plugs Type DP

Bouchon Camlock mâle Type DP

Tappo maschio per femmina Camlock - TIPO DP



DN	Referencia Part n°
12	ZDP012
20	ZDP020
25	ZDP025
32	ZDP032
40	ZDP040
50	ZDP050
65	ZDP065
80	ZDP080
100	ZDP100

Junta Camlock NBR

Camlock NBR Seal

Joint Camlock NBR

Guarnizione in NBR per Camlock



DN	Referencia Part n°
12	JCAMNBR012
20	JCAMNBR020
25	JCAMNBR025
32	JCAMNBR032
40	JCAMNBR040
50	JCAMNBR050
65	JCAMNBR065
80	JCAMNBR080
100	JCAMNBR100

Camlock macho - soldable BW

Camlock male - weldable BW

Adapteur Camlock mâle à souder BW

Camlock maschio a saldare - TIPO BW



TUBO PIPE	Referencia Part n°
21,3	ZABW012
26,9	ZABW020
33,7	ZABW025
42,4	ZABW032
48,3	ZABW040
60,3	ZABW050

Camlock hembra - soldable BW

Camlock female - weldable BW

Adapteur Camlock femelle à souder BW

Camlock femmina a saldare - TIPO BW



TUBO PIPE	Referencia Part n°
21,3	ZDBW012
26,9	ZDBW020
33,7	ZDBW025
42,4	ZDBW032
48,3	ZDBW040
60,3	ZDBW050

Junta Camlock silicona

Camlock silicone seal

Joint Camlock silicone

Guarnizione in silicone per Camlock



DN	Referencia Part n°
12	JCAMS012
20	JCAMS020
25	JCAMS025
32	JCAMS032
40	JCAMS040
50	JCAMS050
65	JCAMS065
80	JCAMS080
100	JCAMS100

Serie Camlock DIN 2828

DIN 2828 Camlock Fittings
Raccords Camlock DIN 2828
Camlock DIN 2828

Camlock macho - rosca hembra NPT Tipo A

Male Camlock coupling, female NPT threaded Type A

Adapteur Camlock mâle - filetage femelle NPT Type A

Camlock maschio - filetto femmina NPT - TIPO A



DN	ROSCA THREAD	Referencia Part n°	€
12	1/2"	ZA012NPT	6,37
20	3/4"	ZA020NPT	9,90
25	1"	ZA025NPT	12,91
32	1" 1/4	ZA032NPT	16,11
40	1" 1/2	ZA040NPT	21,96
50	2"	ZA050NPT	30,43
65	2" 1/2	ZA065NPT	41,62
80	3"	ZA080NPT	53,16
100	4"	ZA100NPT	73,71

Camlock hembra - rosca macho NPT Tipo B

Female CamlockCoupling, male NPT threaded Type B

Adapteur Camlock femelle - filetage mâle NPT Type B

Camlock femmina - filetto maschio conico NPT - TIPO B



DN	ROSCA THREAD	Referencia Part n°	€
12	1/2"	ZB012NPT	14,66
20	3/4"	ZB020NPT	15,40
25	1"	ZB025NPT	21,30
32	1" 1/4	ZB032NPT	31,73
40	1" 1/2	ZB040NPT	32,15
50	2"	ZB050NPT	45,44
65	2" 1/2	ZB065NPT	58,46
80	3"	ZB080NPT	82,09
100	4"	ZB100NPT	116,72

Camlock hembra - rosca hembra NPT Tipo D

Female Camlock Coupling, female NPT threaded Type D

Adapteur Camlock femelle NPT Type D

Camlock femmina - filetto femmina NPT - TIPO D



DN	ROSCA THREAD	Referencia Part n°	€
12	1/2"	ZD012NPT	14,18
20	3/4"	ZD020NPT	16,49
25	1"	ZD025NPT	23,46
32	1" 1/4	ZD032NPT	34,57
40	1" 1/2	ZD040NPT	34,05
50	2"	ZD050NPT	47,56
65	2" 1/2	ZD065NPT	59,40
80	3"	ZD080NPT	84,45
100	4"	ZD100NPT	121,60

Camlock macho - rosca macho NPT Tipo F

Male Camlock coupling, male NPT threaded Type F

Adapteur Camlock mâle NPT Type F

Camlock maschio - filetto maschio conico NPT - TIPO F



DN	ROSCA THREAD	Referencia Part n°	€
12	1/2"	ZF012NPT	7,55
20	3/4"	ZF020NPT	9,29
25	1"	ZF025NPT	13,04
32	1" 1/4	ZF032NPT	17,52
40	1" 1/2	ZF040NPT	27,12
50	2"	ZF050NPT	31,54
65	2" 1/2	ZF065NPT	49,58
80	3"	ZF080NPT	63,17
100	4"	ZF100NPT	103,00

CAMLOCK NPT



EN 14420-7 | DIN 2828

Ver ficha técnica | Check technical sheet

Para una amplia gama de aplicaciones como agua petróleo y productos químicos
For a wide range of applications such as water, petroleum and chemical liquids

CRIMPING FITTINGS FOR HOSES
PIPE FITTINGS
PIPE FITTINGS II
ADAPTORS
WELDING FITTINGS
INDUSTRIAL FITTINGS
ACCESSORIES
CONTROL COMPONENTS
FLOW MEASURING
TRALE LOK

Serie Camlock DIN 2828

DIN 2828 Camlock Fittings
Raccords Camlock DIN 2828
Camlock DIN 2828

Autolock hembra - rosca macho BSP Tipo B

Autolock, female, BSP male threaded Type B

Autolock femelle - filetage mâle BSP Type B

Autolock femmina - filetto maschio conico BSPT - TIPO B



DN	ROSCA THREAD	Referencia Part n°
12	1/2"	ZB012S
20	3/4"	ZB020S
25	1"	ZB025S
32	1"1/4	ZB032S
40	1"1/2	ZB040S
50	2"	ZB050S
65	2"1/2	ZB065S
80	3"	ZB080S
100	4"	ZB100S

Autolock hembra - para manguera Tipo C

Autolock, female, with serrated hose shank Type C

Autolock femelle - pour tuyau Type C

Autolock femmina con inserto per tubo - TIPO C



DN	ROSCA THREAD	Referencia Part n°
12	1/2"	ZC012S
20	3/4"	ZC020S
25	1"	ZC025S
32	1"1/4	ZC032S
40	1"1/2	ZC040S
50	2"	ZC050S
65	2"1/2	ZC065S
80	3"	ZC080S
100	4"	ZC100S

Autolock hembra - rosca hembra BSP Tipo D

Autolock, female, BSP female threaded Type D

Autolock femelle - filetage femelle BSP Type D

Autolock femmina - filetto femmina BSP - TIPO D



DN	ROSCA THREAD	Referencia Part n°
12	1/2"	ZD012S
20	3/4"	ZD020S
25	1"	ZD025S
32	1"1/4	ZD032S
40	1"1/2	ZD040S
50	2"	ZD050S
65	2"1/2	ZD065S
80	3"	ZD080S
100	4"	ZD100S

Autolock hembra - tapón Tipo DC

Autolock, female, DC type dust cap

Autolock femelle - bouchon Type DC

Tappo femmina per Autolock maschio - TIPO DC



DN	Referencia Part n°
12	ZDC012S
20	ZDC020S
25	ZDC025S
32	ZDC032S
40	ZDC040S
50	ZDC050S
65	ZDC065S
80	ZDC080S
100	ZDC100S

AUTOLOCK



Camlock con cierre de seguridad, múltiples aplicaciones como agua, petróleo y productos químicos

Camlock with security lock, for multiple applications such as water, petroleum and chemical liquids

Ver ficha técnica | Check technical sheet

Acoples GUILLEMIN NF E-29572

GUILLEMIN NF E-29572 Fittings
Raccords GUILLEMIN NF E-29572
Raccordi GUILLEMIN NF E-29572

GUILLEMIN con cierre-rosca hembra BSP

GUILLEMIN S.S. with closure-BSP Female thread

GUILLEMIN Inox avec fermeture-Filetage Femelle BSP

GUILLEMIN Inox con chiusura-Filetto femmina BSP



DN	ROSCA THREAD	Referencia Part n°	
20	3/4"	ZGU01C020	
25	1"	ZGU01C025	
32	1" 1/4	ZGU01C032	
40	1" 1/2	ZGU01C040	
50	2"	ZGU01C050	
65	2" 1/2	ZGU01C065	7
80	3"	ZGU01C080	5
100	4"	ZGU01C100	4

GUILLEMIN con cierre-rosca macho BSP

GUILLEMIN S.S. with closure-BSP Male thread

GUILLEMIN Inox avec fermeture-Filetage Mâle BSP

GUILLEMIN Inox con chiusura-Filetto maschio BSP



DN	ROSCA THREAD	Referencia Part n°	
20	3/4"	ZGU02C020	
25	1"	ZGU02C025	
32	1" 1/4	ZGU02C032	
40	1" 1/2	ZGU02C040	
50	2"	ZGU02C050	
65	2" 1/2	ZGU02C065	0
80	3"	ZGU02C080	6
100	4"	ZGU02C100	3

GUILLEMIN con cierre-tapón

GUILLEMIN S.S. with closure-Plug

GUILLEMIN Inox avec fermeture-Bouchon

GUILLEMIN Inox con chiusura-Tappo



DN	Referencia Part n°
20	ZGU04C020
25	ZGU04C025
32	ZGU04C032
40	ZGU04C040
50	ZGU04C050
65	ZGU04C065
80	ZGU04C080
100	ZGU04C100

GUILLEMIN sin cierre-rosca hembra BSP

GUILLEMIN S.S. without closure-BSP Female thread

GUILLEMIN Inox sans fermeture-Filetage Femelle BSP

GUILLEMIN Inox senza chiusura- Filetto femmina BSP



DN	ROSCA THREAD	Referencia Part n°
20	3/4"	ZGU01S020
25	1"	ZGU01S025
32	1" 1/4	ZGU01S032
40	1" 1/2	ZGU01S040
50	2"	ZGU01S050
65	2" 1/2	ZGU01S065
80	3"	ZGU01S080
100	4"	ZGU01S100

GUILLEMIN sin cierre-rosca macho BSP

GUILLEMIN S.S. without closure-BSP Male thread

GUILLEMIN Inox sans fermeture-Filetage Mâle BSP

GUILLEMIN Inox senza chiusura-Filetto maschio BSP



DN	ROSCA THREAD	Referencia Part n°
20	3/4"	ZGU02S020
25	1"	ZGU02S025
32	1" 1/4	ZGU02S032
40	1" 1/2	ZGU02S040
50	2"	ZGU02S050
65	2" 1/2	ZGU02S065
80	3"	ZGU02S080
100	4"	ZGU02S100

GUILLEMIN con cierre-reductor

GUILLEMIN S.S. with closure-Reducer

GUILLEMIN Inox avec fermeture-Réduction

GUILLEMIN Inox con chiusura-Riduzione



DN	Referencia Part n°
40-32	ZGU03C040032
50-32	ZGU03C050032
50-40	ZGU03C050040
65-50	ZGU03C065050
80-65	ZGU03C080065
100-80	ZGU03C100080

Acoples GUILLEMIN NF E-29572

GUILLEMIN NF E-29572 Fittings
Raccords GUILLEMIN NF E-29572
Raccordi GUILLEMIN NF E-29572

GUILLEMIN con cierre-para manguera

GUILLEMIN S.S. with closure-For hose

GUILLEMIN Inox avec fermeture-Pour tuyau

GUILLEMIN Inox con chiusura-Per tubo



DN	L (mm)	TAMAÑO SIZE	Referencia Part n°
40	37	40	ZGU05C040040
45	37	40	ZGU05C040045
50	48	50	ZGU05C050050
50	45,5	50	ZGU05C050055
65	50	65	ZGU05C065065
80	70	80	ZGU05C080080

GUILLEMIN con cierre-soldable

GUILLEMIN S.S. with closure-Welding

GUILLEMIN Inox avec fermeture-À souder

GUILLEMIN Inox con chiusura-Saldabile



DN	Referencia Part n°
40	ZGU06C040040
50	ZGU06C050050
65	ZGU06C065065
80	ZGU06C080080

GUILLEMIN



EN 14420-8 | NF E-29572

Ver ficha técnica | Check technical sheet

Aplicaciones de presión y aspiración en un amplio rango de industrias

Pressure and suction purposes in a wide range of industries

Acoples TW (Tankwagen) DIN 28450

TW (Tankwagen) DIN 28450 Fittings
Raccords TW (Tankwagen) DIN 28450
Raccordi TW (Tankwagen) DIN 28450

TW rosca hembra BSP - acople hembra

TW BSP Female thread - female coupling

TW Filetage Femelle BSP - accouplement Femelle

TW Filetto femmina BSP - accoppiamento femmina



DN	Referencia Part n°
2"	ZMK05032
3"	ZMK08048
4"	ZMK10064

TW rosca hembra BSP - acople macho

TW BSP Female thread - male coupling

TW Filetage Femelle BSP - accouplement Mâle

TW Filetto femmina BSP - accoppiamento maschio



DN	∅	Referencia Part n°
2"	70.5	ZVK05032
3"	102	ZVK08048
4"	128	ZVK10064

TW tapón - acople hembra

TW cap coupling

TW Bouchon - accouplement Femelle

TW Tappo - accoppiamento femmina



DN	Referencia Part n°
2"	ZMB050
3"	ZMB080
4"	ZMB100

TW tapón - acople macho

TW Plug - male coupling

TW Bouchon - accouplement Mâle

TW Tappo - accoppiamento maschio



DN	∅	Referencia Part n°
2"	70.5	ZVB050
3"	102	ZVB080
4"	128	ZVB100

TW acople hembra

TW Female coupling

TW Accouplement Femelle

TW Accoppiamento femmina



DN	Referencia Part n°
2"	ZMKS050050
3"	ZMKS080080

TW acople macho

TW Male coupling

TW Accouplement Mâle

TW Accoppiamento maschio



DN	Referencia Part n°
2"	ZVKS050050
3"	ZVKS080080

CRIMPING FITTINGS
FOR HOSES

PIPE
FITTINGS

PIPE
FITTINGS II

ADAPTORS

WELDING
FITTINGS

INDUSTRIAL
FITTINGS

ACCESSORIES

CONTROL
COMPONENTS

FLOW
MEASURING

TRALE LOK

Accesorios inox para racor industrial

Stainless Steel accessories for industrial fitting
Accessoires acier inox pour raccord industriel
Accessori in acciaio inossidabile per raccordo industriale

Campana inox 304 para racor industrial - cierre 45°

Stainless Steel 304 Crimping Ferrule 45° closure

Jupe pour raccord industriel acier inox 304
-fermeture 45°

Boccola in AISI 304 per raccordo industriale -
chiusura 45°



DN	Ø INT. Ø INNER	Referencia Part n°
25	42,5	ZCA025
32	47	ZCA032
40	55	ZCA040
50	64	ZCA050
65	79	ZCA065
80	98	ZCA080
100	120	ZCA100

Abrazadera EN 14420-3 inox para racor industrial

Stainless Steel clamp for industrial fitting EN14420-3

Collier pour raccord industriel acier inox EN 14420-3

Collare Inox EN 14420-3 per raccordo industriale



Ø MANGUERA Ø HOSE	Ø INT. Ø INNER	Referencia Part n°
12	21-25	ZAB01021025
19	29-33	ZAB01029033
25	36-39	ZAB01035039
32	42-46	ZAB01042046
38	47-51	ZAB01047051
38	49-53	ZAB01049053
38	52-56	ZAB01052056
38	58-62	ZAB01058062
50	60-64	ZAB01060064
50	63-67	ZAB01063067
50	68-72	ZAB01068072
63	74-77	ZAB01074077
63	77-81	ZAB01077081
75	87-90	ZAB01087090
75	89-94	ZAB01089094
80	94-98	ZAB01094098
100	114-119	ZAB01114119

Abrazadera alta presión W4 inox

Stainless steel high pressure clamp W4

Collier haute pression W4 acier inox.

Collare Inox W4 alta pressione



Ø INT. Ø INNER	Referencia Part n°
17-19	ZAB02017019
20-22	ZAB02020022
23-25	ZAB02023025
26-28	ZAB02026028
29-31	ZAB02029031
32-35	ZAB02032035
36-39	ZAB02036039
40-43	ZAB02040043
44-47	ZAB02044047
48-51	ZAB02048051
52-55	ZAB02052055
56-59	ZAB02056059
60-63	ZAB02060063
64-67	ZAB02064067
68-73	ZAB02068073
74-79	ZAB02074079
80-85	ZAB02080085
86-91	ZAB02086091
92-97	ZAB02092097
98-103	ZAB02098103
104-112	ZAB02104112
113-121	ZAB02113121
122-130	ZAB02122130
131-139	ZAB02131139
140-148	ZAB02140148
149-161	ZAB02149161
162-174	ZAB02162174
175-187	ZAB02175187
188-200	ZAB02188200

Racores baja presión 150 LBS

Screw low pressure fittings 150 LBS

Raccords basse pression 150 LBS

Raccordi bassa pressione 150 LBS

Macho fijo espiga FIG.399

Nipple fixed male fig.399

Mâle fixe nipple fig. 399 inox

FIG. 399 - Maschio portagomma



ROSCA THREAD	DN	Referencia Part n°
1/4"	10	ZFIG39904
3/8"	12	ZFIG39906
1/2"	15	ZFIG39908
3/4"	20	ZFIG39912
1"	25	ZFIG39916
1" 1/4	32	ZFIG39920
1" 1/2	40	ZFIG39924
2"	52	ZFIG39932

Uniön macho-macho FIG.150

Union male-male fig.150

Union mâle-mâle fig.150 inox

FIG. 150 - Barilotto maschio - maschio



ROSCA THREAD	Referencia Part n°
1/4"	ZFIG15004
3/8"	ZFIG15006
1/2"	ZFIG15008
3/4"	ZFIG15012
1"	ZFIG15016
1" 1/4	ZFIG15020
1" 1/2	ZFIG15024
2"	ZFIG15032

Tapón macho hexagonal FIG.290

Hexagon male plug FIG.290

Bouchon mâle 150 LBS tête hexagonale FIG.290

FIG. 290 - Tappo maschio testa esagonale



ROSCA THREAD	Referencia Part n°
1/8"	ZFIG29002
1/4"	ZFIG29004
3/8"	ZFIG29006
1/2"	ZFIG29008
3/4"	ZFIG29012
1"	ZFIG29016
1" 1/4	ZFIG29020
1" 1/2	ZFIG29024
2"	ZFIG29032
2" 1/2	ZFIG29040
3"	ZFIG29048
4"	ZFIG29060

Adaptador hexagonal FIG.280

Hexagon nipple FIG.280

Mamelon hexagonal 150 LBS FIG.280

FIG. 280 - Nipples maschio - maschio



ROSCA THREAD	Referencia Part n°
1/4"	ZFIG28004
3/8"	ZFIG28006
1/2"	ZFIG28008
3/4"	ZFIG28012
1"	ZFIG28016
1" 1/4	ZFIG28020
1" 1/2	ZFIG28024
2"	ZFIG28032
2" 1/2	ZFIG28040
3"	ZFIG28048
4"	ZFIG28060

Reducción macho-macho FIG.245

Reducer male-male fig. 245

Réduction mâle-mâle fig. 245 inox

FIG. 245 - Nipples di riduzione maschio - maschio



ROSCA THREAD	Referencia Part n°	
1/4"	ZFIG2450402	
3/8"	ZFIG2450604	
1/2"	ZFIG2450804	
1/2"	ZFIG2450806	
3/4"	ZFIG2451206	
3/4"	ZFIG2451208	
1"	ZFIG2451608	
1"	ZFIG2451612	
1" 1/4	ZFIG2452012	
1" 1/4	ZFIG2452016	2
1" 1/2	ZFIG2452416	7
1" 1/2	ZFIG2452420	1
2"	ZFIG2453220	4
2"	ZFIG2453224	3
2" 1/2	ZFIG2454032	8
3"	ZFIG2454840	3

Tuerca plana FIG.312

Flat nut fig.312

Écrou plat fig.312 inox

FIG. 312 - Dado piano



ROSCA THREAD	Referencia Part n°
1/4"	ZFIG31204
3/8"	ZFIG31206
1/2"	ZFIG31208
3/4"	ZFIG31212
1"	ZFIG31216
1" 1/4	ZFIG31220
1" 1/2	ZFIG31224
2"	ZFIG31232

CRIMPING FITTINGS
FOR HOSES

PIPE
FITTINGS

PIPE
FITTINGS II

ADAPTORS

WELDING
FITTINGS

INDUSTRIAL
FITTINGS

ACCESSORIES

CONTROL
COMPONENTS

FLOW
MEASURING

TRALE LOK

Racores baja presión 150 LBS

Screw low pressure fittings 150 LBS

Raccords basse pression 150 LBS

Raccordi bassa pressione 150 LBS

Tapón hembra hexagonal FIG.300

Hexagon female cap. FIG.300

Bouchon femelle hexagonal 150 LBS FIG.300

FIG. 300 - Tappo esagonale femmina fissa



ROSCA THREAD	Referencia Part n°
1/8"	ZFIG30002
1/4"	ZFIG30004
3/8"	ZFIG30006
1/2"	ZFIG30008
3/4"	ZFIG30012
1"	ZFIG30016
1"1/4	ZFIG30020
1"1/2	ZFIG30024
2"	ZFIG30032
2"1/2	ZFIG30040
3"	ZFIG30048
4"	ZFIG30060

Tapón hembra redondo FIG.301

Round female cap. FIG.301

Bouchon femelle ronde 150 LBS FIG.301

FIG. 301 - Tappo rotondo femmina fissa



ROSCA THREAD	Referencia Part n°
1/8"	ZFIG30102
1/4"	ZFIG30104
3/8"	ZFIG30106
3/4"	ZFIG30112
1"	ZFIG30116
1"1/4	ZFIG30120
1"1/2	ZFIG30124
2"	ZFIG30132
2"1/2	ZFIG30140
3"	ZFIG30148
4"	ZFIG30160

Hasta fin de existencias / Until end of stock / Jusqu'à la fin du stock / Fino ad esaurime

Adaptador hembra BSP DIN 2986 FIG.270

BSP Female coupling DIN 2986 FIG.270

Manchon femelle gaz DIN 2986 150 LBS FIG.270

FIG. 270 - Manicotto femmina-femmina DIN 2986



ROSCA THREAD	Referencia Part n°
1/4"	ZFIG27004
3/8"	ZFIG27006
1/2"	ZFIG27008
3/4"	ZFIG27012
1"	ZFIG27016
1"1/4	ZFIG27020
1"1/2	ZFIG27024
2"	ZFIG27032
2"1/2	ZFIG27040
3"	ZFIG27048
4"	ZFIG27060

Reductor macho-hembra FIG.241

Male-female reducer FIG.241

Réduction 150 LBS MG - FG FIG.241

FIG. 241 - Riduzione maschio - femmina fissa



ROSCA THREAD	R2	Referencia Part n°
1/8"	1/4"	ZFIG2410204
1/4"	3/8"	ZFIG2410406
1/4"	1/2"	ZFIG2410408
3/8"	1/2"	ZFIG2410608
1/2"	3/4"	ZFIG2410812
3/4"	1"	ZFIG2411216
3/4"	1"1/4	ZFIG2411220
1"	1"1/4	ZFIG2411620
1"	1"1/2	ZFIG2411624
1"1/4	1"1/2	ZFIG2412024
1"1/2	2"	ZFIG2412432
2"	2"1/2	ZFIG2413240
2"1/2	3"	ZFIG2414048
3"	4"	ZFIG2414860

Tapón macho cuadrado FIG.291

Male square plug FIG.291

Bouchon mâle 150 LBS tête carrée FIG.291

FIG. 291 - Tappo maschio con testa quadrata



ROSCA THREAD	Referencia Part n°
1/8"	ZFIG29102
1/4"	ZFIG29104
3/8"	ZFIG29106
1/2"	ZFIG29108
3/4"	ZFIG29112
1"	ZFIG29116
1"1/4	ZFIG29120
1"1/2	ZFIG29124
2"	ZFIG29132
2"1/2	ZFIG29140
3"	ZFIG29148
4"	ZFIG29160

Tubo roscado FIG.531

Threaded pipe fig. 531

Tube fileté fig. 531 inox

FIG. 531 - Tubo filettato



ROSCA THREAD	Referencia Part n°
1/4"	ZFIG53104
3/8"	ZFIG53106
1/2"	ZFIG53108
3/4"	ZFIG53112
1"	ZFIG53116
1"1/4	ZFIG53120
1"1/2	ZFIG53124
2"	ZFIG53132

Racores baja presión 150 LBS

Screw low pressure fittings 150 LBS

Raccords basse pression 150 LBS

Raccordi bassa pressione 150 LBS

Reducción hembra-hembra FIG.240

Female-female Reducer socket FIG.240

Réduction Femelle-femelle 150 LBS FIG.240

FIG. 240 - Riduzione femmina-femmina



ROSCA THREAD	R2	Referencia Part n°
1/4"	1/8"	ZFIG2400402
3/8"	1/4"	ZFIG2400604
1/2"	3/8"	ZFIG2400806
3/4"	1/2"	ZFIG2401208
1"	3/4"	ZFIG2401612
1"1/4"	1"	ZFIG2402016
1"1/2"	1"1/4"	ZFIG2402420
2"	1"1/2"	ZFIG2403224
2"1/2"	2"	ZFIG2404032
3"	2"	ZFIG2404832
3"	2"1/2"	ZFIG2404840
4"	2"	ZFIG2406032

Codo 90° macho-hembra FIG.092

Male-female elbow 90° FIG.092

Coude 90° 150 LBS MG - FG FIG.092

FIG. 092 - Adattatore 90° maschio - femmina



ROSCA THREAD	Referencia Part n°
1/8"	ZFIG09202
1/4"	ZFIG09204
3/8"	ZFIG09206
1/2"	ZFIG09208
3/4"	ZFIG09212
1"	ZFIG09216
1"1/4"	ZFIG09220
1"1/2"	ZFIG09224
2"	ZFIG09232
2"1/2"	ZFIG09240
3"	ZFIG09248
4"	ZFIG09260

Codo 90° hembra-hembra FIG.090

Female-female elbow 90° FIG.090

Coude 90° 150 LBS femelle gaz FIG.090

FIG. 090 - Adattatore 90° femmina fissa



ROSCA THREAD	Referencia Part n°
1/8"	ZFIG09002
1/4"	ZFIG09004
3/8"	ZFIG09006
1/2"	ZFIG09008
3/4"	ZFIG09012
1"	ZFIG09016
1"1/4"	ZFIG09020
1"1/2"	ZFIG09024
2"	ZFIG09032
2"1/2"	ZFIG09040
3"	ZFIG09048
4"	ZFIG09060

TE hembra-hembra-hembra FIG.130

Female-female TEE FIG.130

TÉS 150 LBS FG - FG - FG FIG.130

FIG. 130 - Adattatore a T femmina fissa



ROSCA THREAD	Referencia Part n°
1/8"	ZFIG13002
1/4"	ZFIG13004
3/8"	ZFIG13006
1/2"	ZFIG13008
3/4"	ZFIG13012
1"	ZFIG13016
1"1/4"	ZFIG13020
1"1/2"	ZFIG13024
2"	ZFIG13032
2"1/2"	ZFIG13040
3"	ZFIG13048
4"	ZFIG13060

Codo 45° hembra-hembra FIG.120

Female-female elbow 45° FIG.120

Coude 45° 150 LBS FG - FG FIG.120

FIG. 120 - Adattatore 45° femmina fissa



ROSCA THREAD	Referencia Part n°
1/8"	ZFIG12002
1/4"	ZFIG12004
3/8"	ZFIG12006
1/2"	ZFIG12008
3/4"	ZFIG12012
1"	ZFIG12016
1"1/4"	ZFIG12020
1"1/2"	ZFIG12024
2"	ZFIG12032
2"1/2"	ZFIG12040
3"	ZFIG12048
4"	ZFIG12060

Cruz roscada FIG.180

Threaded cross FIG.180

Croix égale 150 LBS FG FIG.180

FIG. 180 - Adattatore a croce femmina fissa



ROSCA THREAD	Referencia Part n°
1/8"	ZFIG18002
1/4"	ZFIG18004
3/8"	ZFIG18006
1/2"	ZFIG18008
3/4"	ZFIG18012
1"	ZFIG18016
1"1/4"	ZFIG18020
1"1/2"	ZFIG18024
2"	ZFIG18032
2"1/2"	ZFIG18040
3"	ZFIG18048
4"	ZFIG18060

CRIMPING FITTINGS
FOR HOSES

PIPE
FITTINGS

PIPE
FITTINGS II

ADAPTORS

WELDING
FITTINGS

INDUSTRIAL
FITTINGS

ACCESSORIES

CONTROL
COMPONENTS

FLOW
MEASURING

TRALE LOK

Racores baja presión 150 LBS

Screw low pressure fittings 150 LBS

Raccords basse pression 150 LBS

Raccordi bassa pressione 150 LBS

Unión 3 piezas hembra-hembra FIG.340

Female-female FIG.340

Union 3 pièces 150 LBS FG - FG FIG.340

FIG. 340 - Unione 3 pezzi femmina - femmina



ROSCA THREAD	Referencia Part n°
1/8"	ZFIG34002
1/4"	ZFIG34004
3/8"	ZFIG34006
1/2"	ZFIG34008
3/4"	ZFIG34012
1"	ZFIG34016
1" 1/4	ZFIG34020
1" 1/2	ZFIG34024
2"	ZFIG34032
2" 1/2	ZFIG34040
3"	ZFIG34048
4"	ZFIG34060

Unión 3 piezas macho-hembra FIG.341

Male-female union FIG.341

Union 3 pièces 150 LBS MG - FG FIG.341

FIG. 341 - Unione 3 pezzi maschio - a saldare



ROSCA THREAD	Referencia Part n°
1/4"	ZFIG34104
3/8"	ZFIG34106
1/2"	ZFIG34108
3/4"	ZFIG34112
1"	ZFIG34116
1" 1/4	ZFIG34120
1" 1/2	ZFIG34124
2"	ZFIG34132
2" 1/2	ZFIG34140
3"	ZFIG34148
4"	ZFIG34160

Macho soldar FIG.149

Welding male fig.149

Mâle à souder fig.149 inox

FIG. 149 - maschio a saldare



ROSCA THREAD	Referencia Part n°
1/4"	ZFIG14904
3/8"	ZFIG14906
1/2"	ZFIG14908
3/4"	ZFIG14912
1"	ZFIG14916
1" 1/4	ZFIG14920
1" 1/2	ZFIG14924
2"	ZFIG14932

Unión 3 piezas hembra-soldar FIG.340HS microfundido

Union 3 fem. welding pieces fig.340hs micro-casting

Union 3 pcs fem. à souder fig.340hs acier moulé

FIG. 340HS - Unione 3 pezzi femmina - a saldare (microfusione)



ROSCA THREAD	Referencia Part n°
1/4"	ZFIG34004HS
3/8"	ZFIG34006HS
1/2"	ZFIG34008HS
3/4"	ZFIG34012HS
1"	ZFIG34016HS
1" 1/4	ZFIG34020HS
1" 1/2	ZFIG34024HS
2"	ZFIG34032HS

Unión 3 piezas soldar FIG.340S microfundid

Union 3 welding pieces fig. 340s micro-casting

Union 3 pièces à souder fig. 340s acier moulé

FIG. 340S - Unione 3 pezzi a saldare (microfusione)



DN	Referencia Part n°
1/4"	ZFIG34004S
3/8"	ZFIG34006S
1/2"	ZFIG34008S
3/4"	ZFIG34012S
1"	ZFIG34016S
1" 1/4	ZFIG34020S
1" 1/2	ZFIG34024S
2"	ZFIG34032S

Unión 3 piezas macho-soldar FIG.341MS mi

Union 3 welding male pieces fig.341ms micro-casting

Union 3 pcs mâle à souder fig.341ms acier moulé

FIG. 341MS - Unione 3 pezzi maschio - a saldare (microfusione)



ROSCA THREAD	Referencia Part n°
1/4"	ZFIG34104MS
3/8"	ZFIG34106MS
1/2"	ZFIG34108MS
3/4"	ZFIG34112MS
1"	ZFIG34116MS
1" 1/4	ZFIG34120MS
1" 1/2	ZFIG34124MS
2"	ZFIG34132MS

Racores baja presión 150 LBS

Screw low pressure fittings 150 LBS

Raccords basse pression 150 LBS

Raccordi bassa pressione 150 LBS

Válvula esfera paso total baja presión 3 piezas

Ball-valve low pressure full bore 3 pcs

Robinet basse pression 2 voies boisseau sphérique passage total 3 pcs

Rubinetto a sfera bassa pressione 3 pcs



ROSCA THREAD	Referencia Part n°
1/4" BSP	BP2V3P14INOX
3/8" BSP	BP2V3P38INOX
1/2" BSP	BP2V3P12INOX
3/4" BSP	BP2V3P34INOX
1" BSP	BP2V3P11INOX
1" 1/4 BSP	BP2V3P114INOX
1" 1/2 BSP	BP2V3P112INOX
2" BSP	BP2V3P2INOX

Válvula esfera paso total baja presión 64 Bar

Ball-valve low pressure full bore 64 Bar

Robinet basse pression 2 voies boisseau sphérique passage total 64 Bar

Rubinetto a sfera bassa pressione passaggio totale 64 Bar



ROSCA THREAD	DN	Referencia Part n°
1/4" BSP	8	BP2V14INOX
3/8" BSP	10	BP2V38INOX
1/2" BSP	15	BP2V12INOX
3/4" BSP	20	BP2V34INOX
1" BSP	25	BP2V11INOX
1" 1/4 BSP	32	BP2V114INOX
1" 1/2 BSP	40	BP2V112INOX
2" BSP	50	BP2V2INOX
2" 1/2 BSP	65	BP2V212INOX
3" BSP	80	BP2V3INOX

Enchufes rápidos AISI 316 239

Quick couplings AISI 316
Coupleurs rapides AISI 316
Innesti rapidi AISI 316

Llaves de paso AISI 316 242

Ball valves AISI 316
Robinets AISI 316
Rubinetti AISI 316

Racores giratorios AISI 316 TrΔle® 245

Swivel fittings AISI 316 TrΔle®
Raccords tournants AISI 316 TrΔle®
Giunti girevole AISI 316 TrΔle®

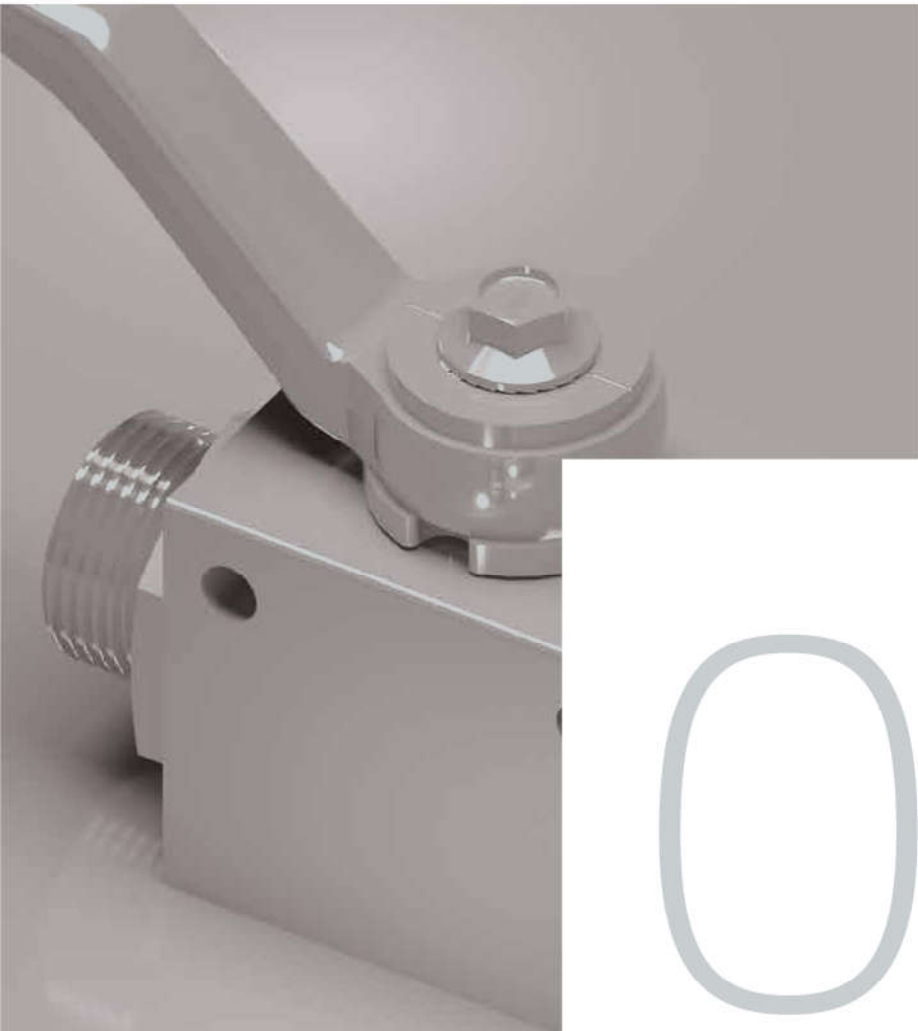

07

| ACCESORIOS

Accessories

Accessoires

Accessori

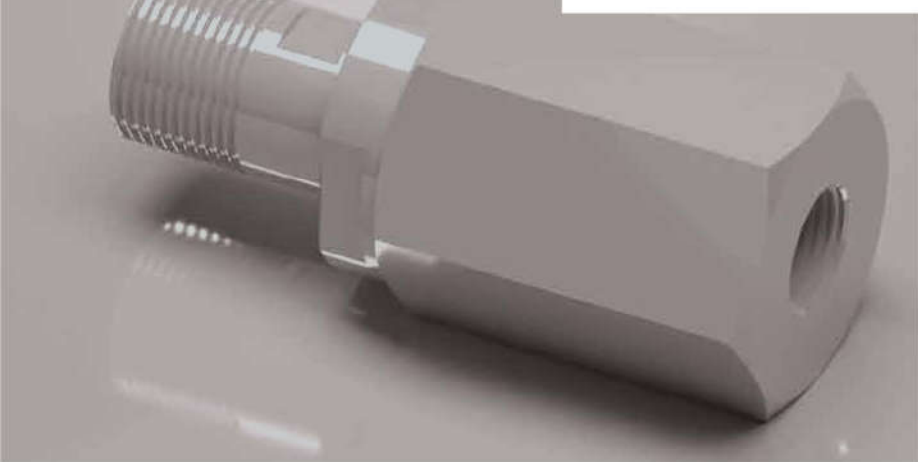

Enchufes rápidos AISI 316

Quick couplings AISI 316
Coupleurs rapides AISI 316
Innesti rapidi AISI 316

Enchufes rápidos ▪ Quick couplings ▪ Quick release couplings ▪ Innesti rapidi | 239



Z8001/Z8002

Z8201/Z8202

Z8008/Z8009

Z8301/Z8302

Z9001/Z9002

Z7111/Z7112

Z9051/Z9052

Enchufes rápidos TrΔle® ▪ Quick couplings TrΔle® ▪ Coupleurs rapides TrΔle® ▪ Innesti rapidi TrΔle® | 241



ZB820

ZB800

ZB830

ZB801

ZB811

ZB900

Llaves de paso AISI 316

Ball valves AISI 316

Robinets AISI 316

Rubinetti AISI 316

Llaves de paso ▪ Ball valves ▪ Robinets ▪ Rubinetti

242



MKH G

MKH_L

MKH_S

MKH G_DN

MKH_L_DN

MKH_S_DN

MK3A-G

Llave 2 vías TrΔle® ▪ 2 ways TrΔle® ball valve ▪ Robinet 2 voies TrΔle® ▪ Rubinetto a sfera TrΔle®

244



ZGB2V

ZGB2V NPT

ZGB2V L

ZGB2V S

Llave 3 vías TrΔle® ▪ 3 ways TrΔle® ball valve ▪ Robinet 3 voies TrΔle® ▪ Rubinetto a sfera TrΔle®

244



ZGB3VH

Manetas ▪ Handles ▪ Leviers ▪ Manopole

244



Z60013

CRIMPING FITTINGS
FOR HOSES

PIPE
FITTINGS

PIPE
FITTINGS II

ADAPTORS

WELDING
FITTINGS

INDUSTRIAL
FITTINGS

ACCESSORIES

CONTROL
COMPONENTS

FLOW
MEASURING

TRALE LOK

Racores giratorios AISI 316 TrΔle®

Swivel fittings AISI 316 TrΔle®
Raccords tournants AISI 316 TrΔle®
Giunti girevole AISI 316 TrΔle®

Racores giratorios TrΔle® ▪ Swivel fittings TrΔle® ▪ Raccords tournants TrΔle® ▪ Giunti girevole TrΔle®



Z GGL

Z GG90

Enchufes rápidos AISI 316

Quick couplings AISI 316
Coupleurs rapides AISI 316
Innesti rapidi AISI 316

Enchufes de punzón ISO 7241-B

Quick coupling ISO 7241-B

Coupleurs rapides à clapet ISO 7241-B

Innesto rapido ISO-B (ISO 7241-B)



ROSCA THREAD	TAMAÑO ISO ISO SIZE	TAMAÑO BG BG SIZE	E. C.	Referencia Part n°
1/4" BSP	6,3	1	M	Z800104
3/8" BSP	10	2	M	Z800106
1/2" BSP	12,5	3	M	Z800108
3/4" BSP	20	4	M	Z800112
1" BSP	25	5	M	Z800116
1"1/4 BSP	40	7	M	Z800120
1"1/2 BSP	40	7	M	Z800124
2" BSP	50	8	M	Z800132
1/4" BSP	6,3	1	H	Z800204
3/8" BSP	10	2	H	Z800206
1/2" BSP	12,5	3	H	Z800208
3/4" BSP	20	4	H	Z800212
1" BSP	25	5	H	Z800216
1"1/4 BSP	40	7	H	Z800220
1"1/2 BSP	40	7	H	Z800224
2" BSP	50	8	H	Z800232

Enchufes de punzón 7241-A

Quick coupling 7241-A

Coupleurs rapides à clapet 7241-A

Innesto rapido ISO-A (ISO 7241-A)



ROSCA THREAD	TAMAÑO ISO ISO SIZE	TAMAÑO BG BG SIZE	E. C.	Referencia Part n°
3/8" BSP	10	2	M	Z820106
1/2" BSP	12,5	3	M	Z820108
3/4" BSP	20	4	M	Z820112
1" BSP	25	5	M	Z820116
1"1/4 BSP	31,5	6	M	Z820120
1"1/2 BSP	40	7	M	Z820124
2" BSP	50	8	M	Z820132
3/8" BSP	10	2	H	Z820206
1/2" BSP	12,5	3	H	Z820208
3/4" BSP	20	4	H	Z820212
1" BSP	25	5	H	Z820216
1"1/4 BSP	31,5	6	H	Z820220
1"1/2 BSP	40	7	H	Z820224
2" BSP	50	8	H	Z820232

Enchufes autoroscantes ISO 14541

Quick screw couplings ISO 14541

Coupleur rapide à visser filetage ISO 14541

Innesti rapidi a vite ISO 14541



ROSCA THREAD	TAMAÑO ISO ISO SIZE	TAMAÑO BG BG SIZE	E. C.	Referencia Part n°
1/4" BSP	6,3	1	M	Z800804
3/8" BSP	10	2	M	Z800806
1/2" BSP	12,5	3	M	Z800808
3/4" BSP	20	4	M	Z800812
1" BSP	25	5	M	Z800816
1"1/4 BSP	40	7	M	Z800820
1"1/2 BSP	40	7	M	Z800824
1/4" BSP	6,3	1	H	Z800904
3/8" BSP	10	2	H	Z800906
1/2" BSP	12,5	3	H	Z800908
3/4" BSP	20	4	H	Z800912
1" BSP	25	5	H	Z800916
1"1/4 BSP	40	7	H	Z800920
1"1/2 BSP	40	7	H	Z800924

Enchufes paso total 7241-B

Quick coupling free flow 7241-B

Coupleurs rapides passage total 7241-B

Innesto rapido ISO-B a passaggio libero



ROSCA THREAD	TAMAÑO ISO ISO SIZE	TAMAÑO BG BG SIZE	E. C.	Referencia Part n°
1/8" BSP	5	0	M	Z830102
1/4" BSP	6,3	1	M	Z830104
3/8" BSP	10	2	M	Z830106
1/2" BSP	12,5	3	M	Z830108
3/4" BSP	20	4	M	Z830112
1" BSP	25	5	M	Z830116
1"1/4 BSP	40	7	M	Z830120
1"1/2 BSP	40	7	M	Z830124
2" BSP	50	8	M	Z830132
1/8" BSP	5	0	H	Z830202
1/4" BSP	6,3	1	H	Z830204
3/8" BSP	10	2	H	Z830206
1/2" BSP	12,5	3	H	Z830208
3/4" BSP	20	4	H	Z830212
1" BSP	25	5	H	Z830216
1"1/4 BSP	40	7	H	Z830220
1"1/2 BSP	40	7	H	Z830224
2" BSP	50	8	H	Z830232

CRIMPING FITTINGS
FOR HOSES

PIPE
FITTINGS

PIPE
FITTINGS II

ADAPTORS

WELDING
FITTINGS

INDUSTRIAL
FITTINGS

ACCESSORIES

CONTROL
COMPONENTS

FLOW
MEASURING

TRAIL LOK

Enchufes rápidos AISI 316

Quick couplings AISI 316
Coupleurs rapides AISI 316
Innesti rapidi AISI 316

Enchufes de válvula plana ISO16028

Flat face quick coupling ISO16028

Coupleurs à clapet face plane ISO16028

Innesto rapido faccia piana ISO16028



Válvula plana autoroscante acoplamiento en presión

Flat face screw couplings, connection u/pressure

Coupleurs face plane à visser, connexion sous pression

Innesto rapido a vite, faccia piana, innesto in pressione



ROSCA THREAD	TAMAÑO ISO ISO SIZE	TAMAÑO BG BG SIZE	E. C.	Referencia Part n°
1/4" BSP	6,3	1	M	Z900104
3/8" BSP	10	2	M	Z900106
1/2" BSP	12,5	3	M	Z900108
3/4" BSP	16	4A	M	Z900112
1" BSP	19	4	M	Z900116
1"1/4 BSP	25	5	M	Z900120
1"1/2 BSP	38	7	M	Z900124
2" BSP	51	8	M	Z900132
1/4" BSP	6,3	1	H	Z900204
3/8" BSP	10	2	H	Z900206
1/2" BSP	12,5	3	H	Z900208
3/4" BSP	16	4A	H	Z900212
1" BSP	19	4	H	Z900216
1"1/4 BSP	25	5	H	Z900220
1"1/2 BSP	38	7	H	Z900224
2" BSP	51	8	H	Z900232

ROSCA THREAD	TAMAÑO ISO ISO SIZE	TAMAÑO BG BG SIZE	Referencia Part n°
3/8" BSP	M30x2	10	Z905106
1/2" BSP	M36x2	12,5	Z905108
3/4" BSP	M36x2	16	Z905112
1" BSP	M43x3	19	Z905116
1"1/4 BSP	M48x3	25	Z905120
1"1/2 BSP	M80x4	40	Z905124
3/8" BSP	M30X2	10	Z905206
1/2" BSP	M36X2	12,5	Z905208
3/4" BSP	M36X2	16	Z905212
1" BSP	M43X3	19	Z905216
1"1/4 BSP	M48X3	25	Z905220
1"1/2 BSP	M80X4	40	Z905224

Enchufes de bola 700 bar acoplamiento en presión

Quick coupling ball type 700 bar connection u/pressure

Coupleurs rapides à bille 700 bar connexion sous pression

Innesti rapido a sfera 700 bar, connessione in pressione



ROSCA THREAD	TAMAÑO ISO ISO SIZE	TAMAÑO BG BG SIZE	E. C.	Referencia Part n°
3/8" NPT	10	2	M	Z711106
3/8" NPT	10	2	H	Z711206

Enchufes rápidos AISI 316

Quick couplings AISI 316
Coupleurs rapides AISI 316
Innesti rapidi AISI 316

TrΔle®

Enchufes TrΔle® 7241-A

Quick couplings 7241-A TrΔle®

Coupleurs 7241-A TrΔle®

Innesto rapido ISO-A (ISO 7241-A) - TrΔle®



ROSCA THREAD	TAMAÑO ISO ISO SIZE	TAMAÑO BG BG SIZE	E. C.	Referencia Part n°
1/4" BSP	6,3	1	M	ZB820104
3/8" BSP	10	2	M	ZB820106
1/2" BSP	12,5	3	M	ZB820108
3/4" BSP	20	4	M	ZB820112
1" BSP	25	5	M	ZB820116
1/4" BSP	6,3	1	H	ZB820204
3/8" BSP	10	2	H	ZB820206
1/2" BSP	12,5	3	H	ZB820208
3/4" BSP	20	4	H	ZB820212
1" BSP	25	5	H	ZB820216

Enchufes TrΔle® 7241-B

Quick couplings 7241-B TrΔle®

Coupleurs TrΔle® 7241-B

Innesto rapido ISO-B (ISO 7241-B) - TrΔle®



ROSCA THREAD	TAMAÑO ISO ISO SIZE	TAMAÑO BG BG SIZE	E. C.	Referencia Part n°
1/8" BSP	5	0	M	ZB800102
1/4" BSP	6,3	1	M	ZB800104
3/8" BSP	10	2	M	ZB800106
1/2" BSP	12,5	3	M	ZB800108
3/4" BSP	20	4	M	ZB800112
1" BSP	25	5	M	ZB800116
1/8" BSP	5	0	H	ZB800202
1/4" BSP	6,3	1	H	ZB800204
3/8" BSP	10	2	H	ZB800206
1/2" BSP	12,5	3	H	ZB800208
3/4" BSP	20	4	H	ZB800212
1" BSP	25	5	H	ZB800216

Enchufes Paso Total TrΔle® 7241-B

Quick couplings free flow TrΔle® 7241-B

Coupleurs passage total TrΔle® 7241-B

Innesto rapido ISO-B a passaggio libero - TrΔle®



ROSCA THREAD	TAMAÑO ISO ISO SIZE	TAMAÑO BG BG SIZE	E. C.	Referencia Part n°
1/4" BSP	6,3	1	M	ZB830104
3/8" BSP	10	2	M	ZB830106
1/2" BSP	12,5	3	M	ZB830108
3/4" BSP	20	4	M	ZB830112
1" BSP	25	5	M	ZB830116
1/4" BSP	6,3	1	H	ZB830204
3/8" BSP	10	2	H	ZB830206
1/2" BSP	12,5	3	H	ZB830208
3/4" BSP	20	4	H	ZB830212
1" BSP	25	5	H	ZB830216

Enchufes NPT TrΔle® 7241-A

Quick couplings 7241-A NPT TrΔle®

Coupleurs 7241-A NPT TrΔle®

Innesto rapido ISO-A (ISO 7241-A) NPT - TrΔle®



ROSCA THREAD	TAMAÑO ISO ISO SIZE	TAMAÑO BG BG SIZE	E. C.	Referencia Part n°
1/4" NPT	6,3	1	M	ZB801104
3/8" NPT	10	2	M	ZB801106
1/2" NPT	12,5	3	M	ZB801108
3/4" NPT	20	4	M	ZB801112
1" NPT	25	5	M	ZB801116
1/4" NPT	6,3	1	H	ZB801204
3/8" NPT	10	2	H	ZB801206
1/2" NPT	12,5	3	H	ZB801208
3/4" NPT	20	4	H	ZB801212
1" NPT	25	5	H	ZB801216

Enchufes NPT TrΔle® 7241-B

Quick couplings 7241-B NPT TrΔle®

Coupleurs 7241-B NPT TrΔle®

Innesto rapido ISO-B (ISO 7241-B) NPT - TrΔle®



ROSCA THREAD	TAMAÑO ISO ISO SIZE	TAMAÑO BG BG SIZE	E. C.	Referencia Part n°
1/4" NPT	6,3	1	M	ZB811104
3/8" NPT	10	2	M	ZB811106
1/2" NPT	12,5	3	M	ZB811108
3/4" NPT	20	4	M	ZB811112
1" NPT	25	5	M	ZB811116
1/4" NPT	6,3	1	H	ZB811204
3/8" NPT	10	2	H	ZB811206
1/2" NPT	12,5	3	H	ZB811208
3/4" NPT	20	4	H	ZB811212
1" NPT	25	5	H	ZB811216

Enchufes de válvula plana ISO16028 TrΔle®

Flat face quick coupling ISO16028 TrΔle®

Coupleurs à clapet face plane ISO16028 TrΔle®

Innesto rapido faccia piana ISO16028 - TrΔle®



ROSCA THREAD	TAMAÑO ISO ISO SIZE	TAMAÑO BG BG SIZE	E. C.	Referencia Part n°
1/4" BSP	6	1	M	ZB900104
3/8" BSP	10	2	M	ZB900106
1/2" BSP	12	3	M	ZB900108
3/4" BSP	16	4A	M	ZB900112
1" BSP	19	4	M	ZB900116
1/4" BSP	6	1	H	ZB900204
3/8" BSP	10	2	H	ZB900206
1/2" BSP	12	3	H	ZB900208
3/4" BSP	16	4A	H	ZB900212
1" BSP	19	4	H	ZB900216

CRIMPING FITTINGS
FOR HOSES

PIPE
FITTINGS

PIPE
FITTINGS II

ADAPTORS

WELDING
FITTINGS

INDUSTRIAL
FITTINGS

ACCESSORIES

CONTROL
COMPONENTS

FLOW
MEASURING

TRALE LOK

CRIMPING FITTINGS
FOR HOSES

PIPE
FITTINGS

PIPE
FITTINGS II

ADAPTORS

WELDING
FITTINGS

INDUSTRIAL
FITTINGS

ACCESSORIES

CONTROL
COMPONENTS

FLOW
MEASURING

TRAILER LOK

Llaves de paso AISI 316

Ball valves AISI 316

Robinets AISI 316

Rubinetti AISI 316

Llave 2 vías rosca hembra BSP

2 Way ball-valves BSP female ISO 228

Robinet haute pression 2 voies boisseau sphérique femelle BSP

Rubinetto a sfera femmina - femmina BSP



DN	ROSCA THREAD	Referencia Part n°
4	1/8" BSP	MKH G 1/8
6	1/4" BSP	MKH G 1/4
10	3/8" BSP	MKH G 3/8
13	1/2" BSP	MKH G 1/2
16	5/8" BSP	MKH G 5/8*
20	3/4" BSP	MKH G 3/4
25	1" BSP	MKH G 1
25	1" 1/4 BSP	MKH G 1 1/4 DN25
25	1" 1/2 BSP	MKH G 1 1/2 DN25

*Hasta fin de existencias / Until end of stock / Jusqu'à la fin du stock / Fino ad esaurimento

Llave 2 vías tubo rígido serie ligera

2 Way ball-valves: tube connection serie L DIN 2353

Robinet haute pression 2 voies boisseau sphérique pour tube rigide série légère

Rubinetto a sfera maschio DIN 2353 - L -



DN	TUBO PIPE	ROSCA THREAD	Referencia Part n°
4	6 L	M12X1,5	MKH 6 L
6	8 L	M14X1,5	MKH 8 L
8	10 L	M16X1,5	MKH 10 L
10	12 L	M18X1,5	MKH 12 L
13	15 L	M22X1,5	MKH 15 L
16	18 L	M26X1,5	MKH 18 L
20	22 L	M30X2	MKH 22 L
25	28 L	M36X2	MKH 28 L
25/32	35 L	M45X2	MKH 35 L
25/40	42 L	M52X2	MKH 42 L

Llave 2 vías tubo rígido serie pesada

2 Way ball-valves: tube connection serie S DIN 2353

Robinet haute pression 2 voies boisseau sphérique pour tube rigide série lourde

Rubinetto a sfera maschio DIN 2353 - S -



DN	TUBO PIPE	ROSCA THREAD	Referencia Part n°
4	8 S	M16X1,5	MKH 8 S
6	10 S	M18X1,5	MKH 10 S
8	12 S	M20X1,5	MKH 12 S
10	14 S	M22X1,5	MKH 14 S
13	16 S	M24X1,5	MKH 16 S
13	20 S	M30X2	MKH 20 S DN13
16	20 S	M30X2	MKH 20 S
25	30 S	M42X2	MKH 30 S
20	25 S	M36X2	MKH 25 S
25/32	38 S	M52X2	MKH 38 S

Llave 2 vías rosca hembra BSP paso total

Ball-valves BSP female

Robinet haute pression 2 voies boisseau sphérique femelle

Rubinetto a sfera femmina - femmina BSP



DN	ROSCA THREAD	Referencia Part n°
32	1" 1/4 BSP	MKH G 1 1/4 DN32
50	2" BSP	MKH G 2 DN50

Llave 2 vías tubo rígido L paso total

Ball-valves: tube connection serie L DIN 2353 full bore

Robinet haute pression 2 voies boisseau sphérique Métrique série légère passage total

Rubinetto a sfera maschio DIN 2353 - L -



DN	TUBO PIPE	ROSCA THREAD	Referencia Part n°
35	35 L	M45X2	MKH 35 L DN35

Llave 2 vías tubo rígido S paso total

Ball-valves: tube connection serie S DIN 2353 full bore

Robinet haute pression 2 voies boisseau sphérique Métrique série légère passage total

Rubinetto a sfera maschio DIN 2353 - S -



DN	TUBO PIPE	ROSCA THREAD	Referencia Part n°
32	38 S	M52x2	MKH 38 S DN32

Llave 3 vías hembra - hembra - hembra BSP paso en

3 Way ball-valve female BSP L flow

Robinet haute pression 3 voies boisseau sphérique femelle BSP passage en L

Rubinetto a sfera 3 vie femmina BSP passaggio in L



DN	ROSCA THREAD	Referencia Part n°
4	1/8" BSP	MK3A-G 1/8
6	1/4" BSP	MK3A-G 1/4
10	3/8" BSP	MK3A-G 3/8
13	1/2" BSP	MK3A-G 1/2
20	3/4" BSP	MK3A-G 3/4
25	1" BSP	MK3A-G 1
25	1" 1/4 BSP	MK3A-G 1 1/4
40	1" 1/2 BSP	MK3A-G 1 1/2

LLAVES DE PASO AISI 316 TRΔLE®

Ball valves AISI 316 TrΔle®
 Robinets AISI 316 TrΔle®
 Rubinetti AISI 316 TrΔle®

Manetas 1
 Handles for ball-valves
 Leviers pour robinets
 Maniglia

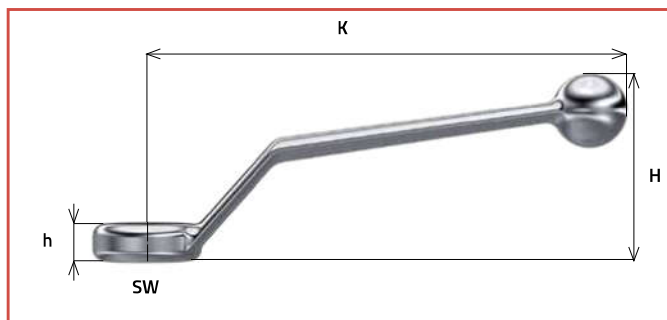

Manetas 2
 Handles for ball-valves
 Leviers pour robinets
 Maniglia

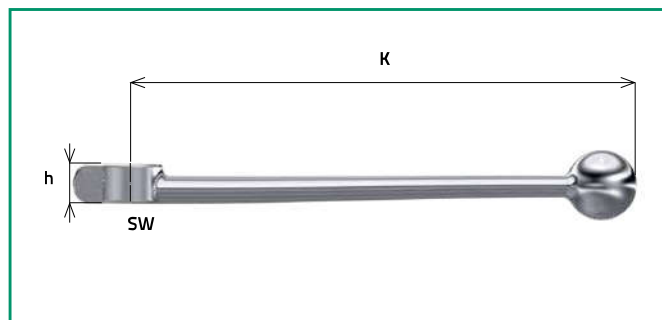

	SW	Zinc Zinc						Aluminio Aluminum			INOX/SS316L			Acero Steel		
Serie BSP 1/8 - 1/4 - 3/8 - 1/2 - 5/8	9	A60013155330* (1)			AR603722*						Z60013155330 *			C600063*		
Serie DIN 6 - 8 - 10 - 12 - 14 - 15 - 16		H	J	K	H	J	K	H	J	K	H	J	K	H	J	K
		45	8.7	155	-	10	155				45	8.7	155	47	9	155
Serie BSP 5/8	12							L501741* (1)								
Serie DIN 18		H	J	K	H	J	K	H	J	K	H	J	K	H	J	K
							55	12	160							
Serie BSP 3/4 - 1 - 1 1/4	14	A60013155331* (1)						LR606745 *			Z60013155331*			C708618*		
Serie DIN 22 - 25 - 28 - 30 - 35 - 38		H	J	K	H	J	K	H	J	K	H	J	K	H	J	K
		-	13	200	-	12	200	-	13	200	64	12	171			
Serie BSP 1 1/4 - 1 1/2 - 2	17							LR801799* (1)			Z60013155332*					
Serie DIN 3 3-5 - 38 - 42		H	J	K	H	J	K	H	J	K	H	J	K	H	J	K
		-	16	320	-	15	90									

Las llaves se suministran con maneta de zinc o aluminio
 Handles for ball-valves are supplied with zinc or aluminum
 Leviers pour robinets sont fournies avec une poignée en zinc ou en aluminium
 Maniglia sono fornite con manico in zinco o alluminio

(1) Maneta suministrada junto a la llave / Handles are supplied for ball-valves / Leviers sont fournies pour robinets / Maniglia sono fornite con manico

CRIMPING FITTINGS FOR HOSES
 PIPE FITTINGS
 PIPE FITTINGS II
 ADAPTORS
 WELDING FITTINGS
 INDUSTRIAL FITTINGS
 ACCESSORIES
 CONTROL COMPONENTS
 FLOW MEASURING
 TRΔLE LOK

Llaves de paso AISI 316

Ball valves AISI 316
Robinets AISI 316
Rubinetti AISI 316

TrΔle®

Llave 2 vías rosca hembra BSP TrΔle®

2 ways ball valve female BSP TrΔle®

Robinet haute pression 2 voies boisseau sphérique femelle BSP TrΔle®

Rubinetto a sfera 2 vie femmina BSP - TrΔle®



DN	ROSCA THREAD	Referencia Part n°
4	1/8" BSP	ZGB2V 1/8
6	1/4" BSP	ZGB2V 1/4
10	3/8" BSP	ZGB2V 3/8
13	1/2" BSP	ZGB2V 1/2
20	3/4" BSP	ZGB2V 3/4
25	1" BSP	ZGB2V 1

Llave 2 vías rosca hembra NPT TrΔle®

2 ways ball valve female NPT TrΔle®

Robinet haute pression 2 voies boisseau sphérique femelle NPT TrΔle®

Rubinetto a sfera 2 vie femmina NPT - TrΔle®



DN	ROSCA THREAD	Referencia Part n°
6	1/4" NPT	ZGB2V 1/4 NPT
10	3/8" NPT	ZGB2V 3/8 NPT
12	1/2" NPT	ZGB2V 1/2 NPT
19	3/4" NPT	ZGB2V 3/4 NPT
25	1" NPT	ZGB2V 1 NPT

Llave 2 vías tubo rígido serie ligera TrΔle®

2 ways ball valve: tube connector light serie TrΔle®

Robinet haute pression 2 voies boisseau sphérique sortie pour tube rigide Série légère TrΔle®

Rubinetto a sfera 2 vie maschio DIN2353 (serie L) - TrΔle®



DN	TUBO PIPE	ROSCA THREAD	Referencia Part n°
6	8 L	M14X1,5	ZGB2V 8 L
8	10 L	M16X1,5	ZGB2V 10 L
10	12 L	M18X1,5	ZGB2V 12 L
13	15 L	M22X1,5	ZGB2V 15 L
16	18 L	M26X1,5	ZGB2V 18 L
20	22 L	M30X2	ZGB2V 22 L
25	28 L	M36X2	ZGB2V 28 L

Llave 2 vías tubo rígido serie pesada TrΔle®

2 ways ball valve: tube connector heavy serie TrΔle®

Robinet haute pression 2 voies boisseau sphérique sortie pour tube rigide Série lourde TrΔle®

Rubinetto a sfera 2 vie maschio DIN2353 (serie S) - TrΔle®



DN	TUBO PIPE	ROSCA THREAD	Referencia Part n°
4	8 S	M16X1,5	ZGB2V 8 S
6	10 S	M18X1,5	ZGB2V 10 S
8	12 S	M20X1,5	ZGB2V 12 S
10	14 S	M22X1,5	ZGB2V 14 S
13	16 S	M24X1,5	ZGB2V 16 S
16	20 S	M30X2	ZGB2V 20 S
20	25 S	M36X2	ZGB2V 25 S

Llave 3 vías TrΔle® hembra - hembra - hembra BSP paso en L

3 Way ball-valve female ISO 228

Robinet haute pression 3 voies boisseau sphérique femelle

Rubinetto a sfera 3 vie femmina BSP (passaggio L) - TrΔle®



DN	R1	Referencia Part n°
6	1/4" BSP	ZGB3VH 1/4
10	3/8" BSP	ZGB3VH 3/8
13	1/2" BSP	ZGB3VH 1/2
20	3/4" BSP	ZGB3VH 3/4
25	1" BSP	ZGB3VH 1

Manetas para llaves de paso

Handles for ball-valves

Leviers pour robinets

Manopole per rubinetti a sfera



TAMAÑO SIZE	Referencia Part n°
HEX9	Z60013155330
HEX14	Z60013155331
HEX17	Z60013155332

Ver tabla de dimensiones en pág 243 / See dimension table in page 243 / Voir table de dimensions à la page 243 / Vedere tabella di dimensioni a pagina 243

Racores giratorios AISI 316 TrΔle®

Swivel fittings AISI 316 TrΔle®
Raccords tournants AISI 316 TrΔle®
Giunti girevole AISI 316 TrΔle®

Racores giratorios rectos TrΔle®

Straight swivel fittings TrΔle®

Raccord tournant droit TrΔle®

Giunto girevole diritto - TrΔle®



ROSCA THREAD	Referencia Part n°
1/4" BSP	Z GGL 1/4
3/8" BSP	Z GGL 3/8
1/2" BSP	Z GGL 1/2
3/4" BSP	Z GGL 3/4
1" BSP	Z GGL 1
1" 1/4 BSP	Z GGL 1 1/4
1" 1/2 BSP	Z GGL 1 1/2
2" BSP	Z GGL 2

Racores giratorios 90º TrΔle®

Elbow 90º swivel female TrΔle®

Raccord tournant coude 90º TrΔle®

Giunto girevole 90º - TrΔle®



ROSCA THREAD	Referencia Part n°
1/4" BSP	Z GG90 1/4
3/8" BSP	Z GG90 3/8
1/2" BSP	Z GG90 1/2
3/4" BSP	Z GG90 3/4
1" BSP	Z GG90 1
1" 1/4 BSP	Z GG90 1 1/4
1" 1/2 BSP	Z GG90 1 1/2
2" BSP	Z GG90 2

SWIVEL FITTINGS UNDER REQUEST
RACORES GIRATORIOS BAJO PEDIDO



NPT

JIC

UNF

Componentes hidráulicos AISI 316 249

Hydraulic Components AISI 316
Composants Hydrauliques AISI 316
Componenti Idraulici AISI 316

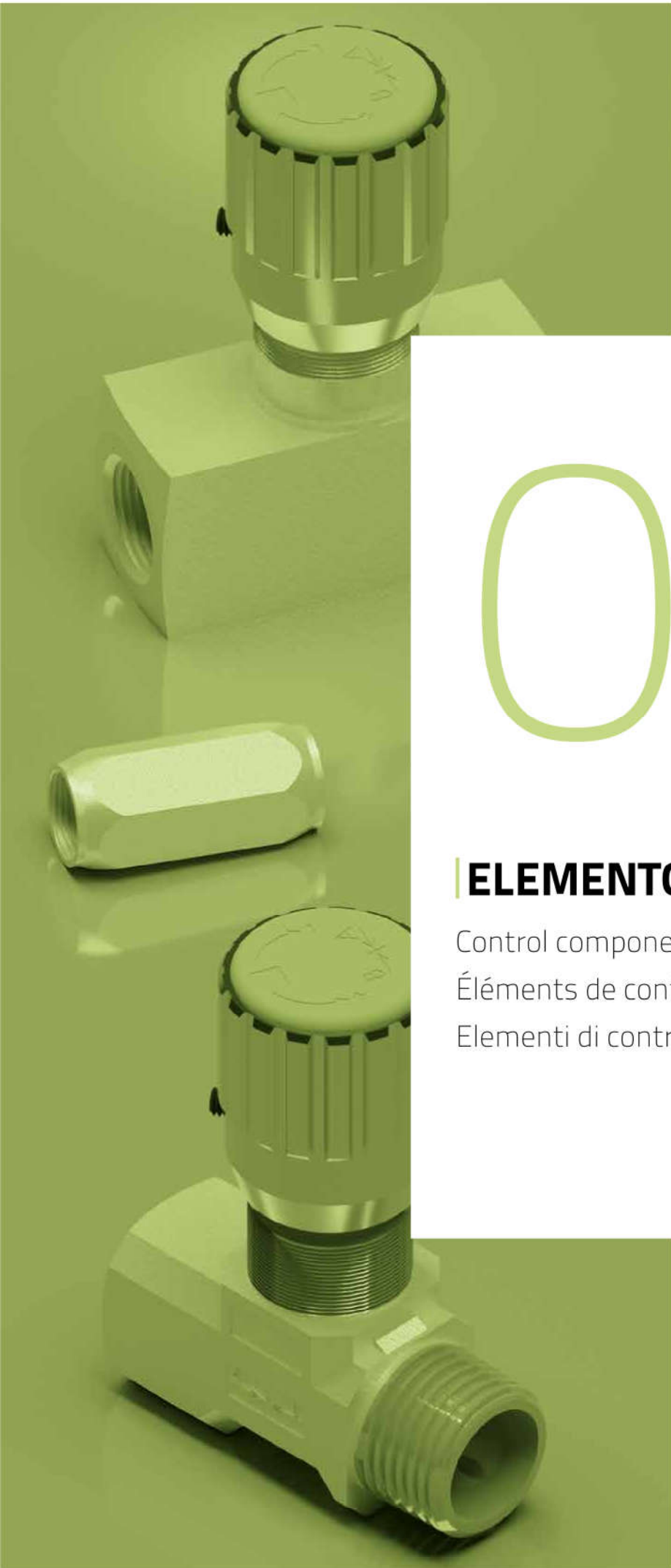

08

ELEMENTOS DE CONTROL

Control components

Éléments de contrôle

Elementi di controllo

Componentes hidráulicos AISI 316

Hydraulic Components AISI 316
Composants Hydrauliques AISI 316
Componenti Idraulici AISI 316

Reguladores caudal ▪ Flow control valves ▪ Régulateurs de débit ▪ Regulatori di flusso

| 249



ZFT2251B



ZFT2253U



ZFT22512B



ZFT22572B



ZFT22575U

Anti-retornos ▪ Check-valves ▪ Clapet antiretour ▪ Valvole di ritegno

| 250



Z FPR

Anti-retornos TrΔle® ▪ Check-valves TrΔle® ▪ Clapet antiretour TrΔle® ▪ Valvole di ritegno TrΔle®

| 250



ZVTO

Limitadoras ▪ Relief valves ▪ Limiteurs de pression ▪ Valvole de regolazione

| 250



ZLIM

Componentes hidráulicos AISI 316

Hydraulic Components AISI 316
Composants Hydrauliques AISI 316
Componenti Idraulici AISI 316

Regulador caudal forjado bidireccional 350 Bar

Forged bidirectional flow control valve 350 Bar

Régulateur débit bidirectionnel forgé 350 Bar

Regolatore di flusso bidirezionale 350 Bar



ROSCA THREAD	CAUDAL MÁX. MAX. FLOW (l/min)	Referencia Part n°	
1/4" BSP M17x1	12	ZFT2251B04	1
3/8" BSP M20x1	30	ZFT2251B06	4
1/2" BSP M25x1,5	45	ZFT2251B08	1
3/4" BSP M30x1,5	85	ZFT2251B12	0

Regulador caudal forjado unidireccional 350 Bar

Forged unidirectional flow control valve 350 Bar

Régulateur débit unidirectionnel forgé 350 Bar

Regolatore di flusso unidirezionale 350 Bar



ROSCA THREAD	CAUDAL MÁX. MAX. FLOW (l/min)	Referencia Part n°	
1/4" BSP M17x1	12	ZFT2253U04	
3/8" BSP M20x1	30	ZFT2253U06	
1/2" BSP M25x1,5	45	ZFT2253U08	
3/4" BSP M30x1,5	85	ZFT2253U12	

Regulador caudal forjado bidireccional macho/hembra 350 Bar

Forged unidirectional flow control valve male/female 350 Bar

Régulateur débit bidirectionnel forgé mâle/femelle 350 Bar

Regolatore di flusso unidirezionale maschio-femmina 350 Bar



ROSCA THREAD	CAUDAL MÁX. MAX. FLOW (l/min)	Referencia Part n°	
1/8" BSP M15x1	10	ZFT22512B02	
1/4" BSP M17x1	13	ZFT22512B04	
3/8" BSP M20x1	30	ZFT22512B06	
1/2" BSP M25x1,5	60	ZFT22512B08	
3/4" BSP M30x1,5	80	ZFT22512B12	

Regulador caudal bidireccional 400 Bar

Bidirectional flow control valve 400 Bar

Régulateur débit bidirectionnel 400 Bar

Regolatore di flusso bidirezionale 400 bar



ROSCA THREAD	CAUDAL MÁX. MAX. FLOW (l/min)	Referencia Part n°	
1/4" BSP M20x1	13	ZFT22572B04	
3/8" BSP M25x1,5	38	ZFT22572B06	
1/2" BSP M30x1,5	50	ZFT22572B08	
3/4" BSP M40x1,5	80	ZFT22572B12	
1" BSP M50x1,5	190	ZFT22572B16	
1" 1/4 BSP M50x1,5	195	ZFT22572B20	
1" 1/2 BSP M55x2	200	ZFT22572B24	
2" BSP M65x2	200	ZFT22572B32	

Regulador caudal unidireccional 400 Bar

Unidirectional flow control valve 400 Bar

Régulateur débit unidirectionnel 400 Bar

Regolatore di flusso unidirezionale 400 Bar

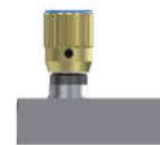

ROSCA THREAD	CAUDAL MÁX. MAX. FLOW (l/min)	Referencia Part n°	
1/8" BSP M17x1	6	ZFT22575U02	
1/4" BSP M20x1	14	ZFT22575U04	
3/8" BSP M25x1,5	20	ZFT22575U06	
1/2" BSP M30x1,5	45	ZFT22575U08	
3/4" BSP M40x1,5	80	ZFT22575U12	
1" BSP M50x1,5	180	ZFT22575U16	
1" 1/4 BSP M50x1,5	200	ZFT22575U20	
1" 1/2 BSP M55x2	200	ZFT22575U24	
2" BSP M65x2	200	ZFT22575U32	

Componentes hidráulicos AISI 316

Hydraulic Components AISI 316
Composants Hydrauliques AISI 316
Componenti Idrraulici AISI 316

Anti-retorno en línea BSP



Check-valve line mounting BSP

Clapet antiretour simple en ligne BSP

Valvole di ritegno in linea BSP



ROSCA THREAD	TARAJE (bar) SETTING (bar)	Referencia Part n°
1/4" BSP	0,5	Z VSR 1/4
1/4" BSP	2,5	Z VSR 1/4-2.5
1/4" BSP	5	Z VSR 1/4-5
1/4" BSP	10	Z VSR 1/4-10
3/8" BSP	0,5	Z VSR 3/8
3/8" BSP	2,5	Z VSR 3/8-2.5
3/8" BSP	5	Z VSR 3/8-5
3/8" BSP	10	Z VSR 3/8-10
1/2" BSP	0,5	Z VSR 1/2
1/2" BSP	2,5	Z VSR 1/2-2.5
1/2" BSP	5	Z VSR 1/2-5
1/2" BSP	10	Z VSR 1/2-10
3/4" BSP	0,5	Z VSR 3/4
1" BSP	0,5	Z VSR 1
1" 1/4 BSP	0,5	Z VSR 1 1/4
1" 1/2 BSP	0,5	Z VSR 1 1/2

Para otras presiones de tarado estandar, consultar. / For other standard spring pressures, consult us. / Pour d'autres pressions ressort standard, consultez-nous. / Per altre pressioni di taratura standard, consultare.

Anti-retornos en línea BSP TrΔle®

Check-valve line mounting BSP TrΔle®

Clapet antiretour simple en ligne BSP TrΔle®

Valvole di ritegno in linea BSP - TrΔle®



ROSCA THREAD	TARAJE (bar) SETTING (bar)	Referencia Part n°
1/4" BSP	0,5	ZVT001004
3/8" BSP	0,5	ZVT001006
1/2" BSP	0,5	ZVT001008
3/4" BSP	0,5	ZVT001012

Para otras presiones de tarado estandar, consultar. / For other standard spring pressures, consult us. / Pour d'autres pressions ressort standard, consultez-nous. / Per altre pressioni di taratura standard, consultare.

Limitadoras en línea BSP

Relief valves in line BSP

Limiteurs de pression en ligne BSP

Valvola limitatrice in linea BSP



ROSCA THREAD	CAMPO REG. (bar) REG RATE (bar)	CAUDAL MÁX. MAX. FLOW (l/min)	Referencia Part n°
1/2" BSP	25-100	40	ZLIM1225100
1/2" BSP	60-210	40	ZLIM1260210
1/2" BSP	100-300	40	ZLIM12100300

*No sólo vendemos productos,
somos tu proveedor de
soluciones*

PROYECTOS



PROJECTS

*We are involved in
key industrial sectors.*

Racores de control 257

Test couplings
Prises de pression
Prese di pressione

Conexiones Micro-hose 258

Micro-hose fittings
Embouts Capillaire
Raccordi Micro-tubo

Instrumentos de medición 259

Pressure gauges AISI 316 with glycerin
Manomètre AISI 316 avec glycérine
Manometri AISI 316 a bagno di glicerina

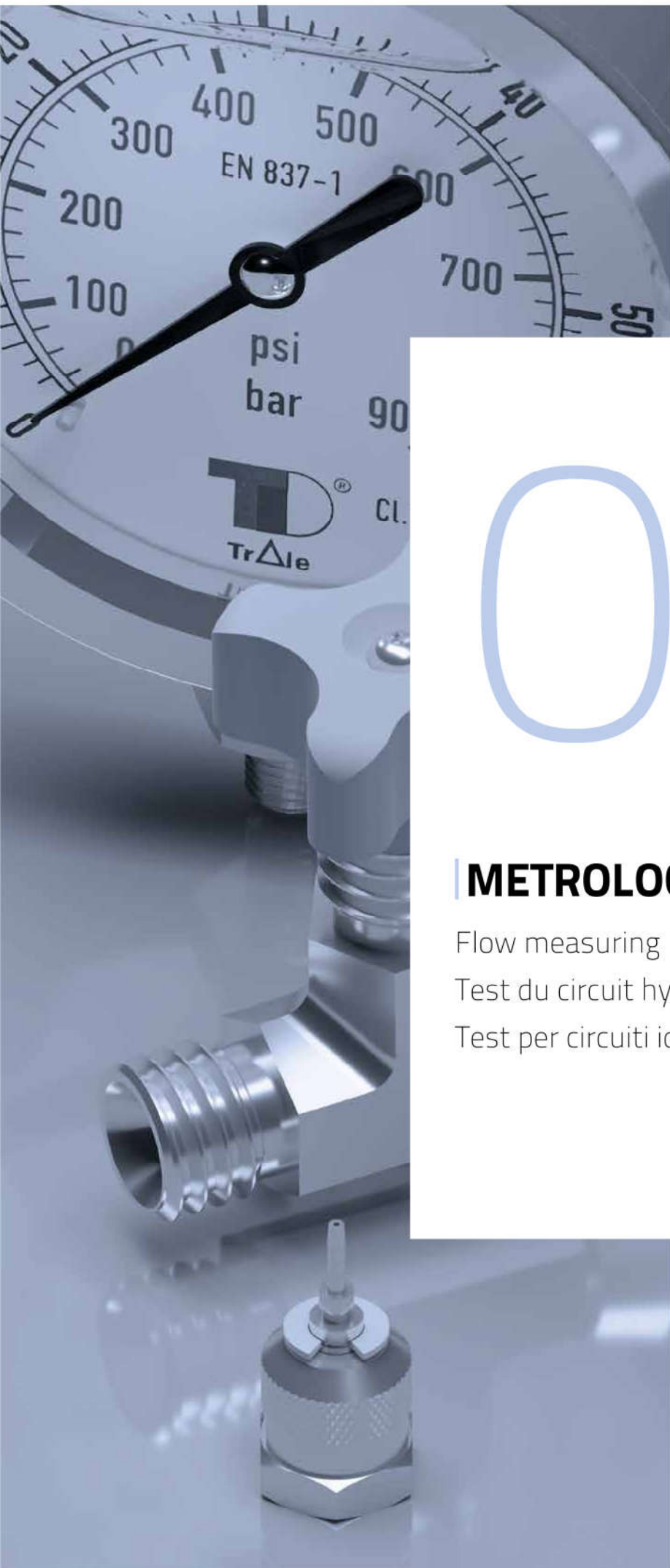

09

METROLOGÍA

Flow measuring

Test du circuit hydraulique

Test per circuiti idraulici

Racores de control

Test couplings
Prises de pression
Prese di pressione

Racores de Control ▪ Checking fittings ▪ Prises de pression ▪ Prese di pressione



Z MPR...C/J



Z MPR TLM



Z MPR DL/S



Z MPR...NPT



Z MPR M

Conexiones Micro-hose

Micro-hose fittings
Embouts Capillaire
Raccordi Micro-tubo

CRIMPING FITTINGS
FOR HOSES

Conexiones Micro-hose ▪ Micro-hose fittings ▪ Embouts Capillaire ▪ Raccordi Micro-tubo

| 258

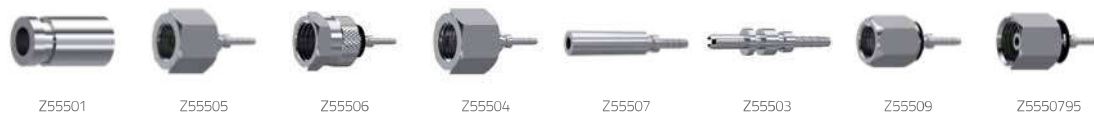

PIPE
FITTINGS

PIPE
FITTINGS II

ADAPTORS

WELDING
FITTINGS

INDUSTRIAL
FITTINGS

ACCESSORIES

CONTROL
COMPONENTS

FLOW
MEASURING

TRALE LOK

CRIMPING FITTINGS
FOR HOSES

Instrumentos de medición

Pressure gauges AISI 316 with glycerin
Manomètre AISI 316 avec glycérine
Manometri AISI 316 a bagno di glicerina

PIPE
FITTINGS

Manómetros inox glicerina DN 63 ▪ Pressure gauge DN 63 with glycerin ▪ Manomètre avec glycérine DN 63 ▪
Manometro DN 63 a bagno di glicerina

259



ZMF163..V



ZMF163..DB

PIPE
FITTINGS II

Manómetros inox glicerina DN 100 ▪ Pressure gauge DN 100 with glycerin ▪ Manomètre avec glycérine DN 100 ▪
Manometro DN 100 a bagno di glicerina

259



ZMF100..V



ZMF100..DB

ADAPTORS

Protectores manómetros ▪ Valves for manometers ▪ Valves pour manomètres ▪ Esclusori per manometro

260



Z FPE



Z FPEA



ZFT2299

WELDING
FITTINGS

INDUSTRIAL
FITTINGS

ACCESSORIES

CONTROL
COMPONENTS

FLOW
MEASURING

TRALE LOK

Racores de control

Test couplings
Prises de pression
Prese di pressione

Racores de control BSP con junta y capuchón metálico

Racores de control BSP con junta y capuchón metálico

Prises de pression avec joint plat et capouchon métallique

Mini-presa di controllo con tappo metallico - maschio BSP con guarnizione



ROSCA THREAD	Referencia Part n°
1/8" BSP	Z MPR 1/8 G
1/4" BSP	Z MPR 1/4 G
3/8" BSP	Z MPR 3/8 G
1/2" BSP	Z MPR 1/2 G

Racores de control TLM con capuchón metálico

Racores de control TLM con capuchón metálico

Prises de pression TLM avec capouchon métallique

Mini-presa di controllo con tappo metallico - femmina girovole metrica 24°



TUBO PIPE	SERIE SERIES	ROSCA THREAD	Referencia Part n°
6	L	M12x1,5	Z MPR TLM 6L
8	L	M14x1,5	Z MPR TLM 8L
10	L	M16x1,5	Z MPR TLM 10L
12	L	M18x1,5	Z MPR TLM 12L
15	L	M22x1,5	Z MPR TLM 15L
6	S	M14x1,5	Z MPR TLM 6S
8	S	M16x1,5	Z MPR TLM 8S
10	S	M18x1,5	Z MPR TLM 10S
12	S	M20x1,5	Z MPR TLM 12S

Racor de control intermedio para tubo metálico

Racor de control intermedio para tubo metálico

Raccord intermédiaire pour tube métallique

Mini-presa di controllo con tappo metallico - raccordo intermedio per tubo rigido



TUBO PIPE	SERIE SERIES	ROSCA THREAD	Referencia Part n°
6	L	M12X1,5	Z MPR DL 6
8	L	M14X1,5	Z MPR DL 8
10	L	M16X1,5	Z MPR DL 10
12	L	M18X1,5	Z MPR DL 12
15	L	M22X1,5	Z MPR DL 15
18	L	M26X1,5	Z MPR DL 18
22	L	M30X2	Z MPR DL 22
28	L	M36X2	Z MPR DL 28
35	L	M45X2	Z MPR DL 35
42	L	M52X2	Z MPR DL 42
6	S	M14X1,5	Z MPR DS 6
8	S	M16X1,5	Z MPR DS 8
10	S	M16X1,5	Z MPR DS 10
12	S	M18X1,5	Z MPR DS 12
14	S	M22X1,5	Z MPR DS 14
16	S	M24X1,5	Z MPR DS 16
20	S	M30X2	Z MPR DS 20
25	S	M36X2	Z MPR DS 25
30	S	M42X2	Z MPR DS 30
38	S	M52X2	Z MPR DS 38

Racores de control NPT con capuchón metálico

Racores de control NPT con capuchón metálico

Prises de pression NPT avec capouchon métallique

Mini-presa di controllo con tappo metallico - maschio NPT



ROSCA THREAD	Referencia Part n°
1/8" NPT	Z MPR 1/8 NPT
1/4" NPT	Z MPR 1/4 NPT
3/8" NPT	Z MPR 3/8 NPT

Racores de control Métrico con Junta y capuchón metal

Racores de control Métrico con Junta y capuchón metal

Prises de pression métrique avec joint plat et capouchon métallique

Mini-presa di controllo con tappo metallico - maschio metrico con guarnizione



ROSCA THREAD	Referencia Part n°
M10X1.5	Z MPR M 10X1.5
M12X1.5	Z MPR M 12X1.5
M14X1.5	Z MPR M 14X1.5
M16X1.5	Z MPR M 16X1.5

CRIMPING FITTINGS
FOR HOSES

PIPE
FITTINGS

PIPE
FITTINGS II

ADAPTORS

WELDING
FITTINGS

INDUSTRIAL
FITTINGS

ACCESSORIES

CONTROL
COMPONENTS

FLOW
MEASURING

TRALE LOK

CRIMPING FITTINGS
FOR HOSES

PIPE
FITTINGS

PIPE
FITTINGS II

ADAPTORS

WELDING
FITTINGS

INDUSTRIAL
FITTINGS

ACCESSORIES

CONTROL
COMPONENTS

FLOW
MEASURING

TRALE LOK

Conexiones Micro-hose

Micro-hose fittings
Embouts Capillaire
Raccordi Micro-tubo

Casquillos AISI-303

Casquillos AISI-303

Jupes AISI-303

Boccola per micro-tubo (AISI-303)



DN	Referencia Part n°	
2	Z555010100	2

Hembra asiento plano con junta manómetro

Hembra asiento plano con junta manómetro

Embout femelle tournante fond plat avec o'ring pour manomètre Minimes

Femmina sede piana con o'ring per manometro

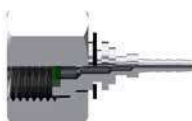

DN	ROSCA THREAD	Referencia Part n°
2	1/4" BSP	Z555050404
2	1/2" BSP	Z555050808

Hembra giratoria de control

Hembra giratoria de control

Embout femelle tournante de control Métrique Minimes

Presa di pressione femmina



DN	ROSCA THREAD	Referencia Part n°
2	M16X2	Z555069523

Hembra giratoria BSP 60°

Hembra giratoria BSP 60°

Embout femelle tournante gaz cyl BSP 60° Minimes

Femmina girevole BSP 60°

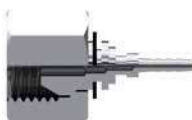

DN	ROSCA THREAD	Referencia Part n°
2	1/8" BSP	Z555040202
2	1/4" BSP	Z555040404
2	3/8" BSP	Z555040606

Espiga lisa Métrica

Espiga lisa Métrica

Embout lisse Métrique Minimes

Estremitá tubolare Metrica



DN	TUBO PIPE	Referencia Part n°
2	6	Z555070600
2	8	Z555070800

Macho de control

Macho de control

Embout mâle manomètre

Presa di pressione maschio



DN	Referencia Part n°
2	Z555030325

Hembra giratoria recta JIC 37°

Hembra giratoria recta JIC 37°

Embout femelle tournante JIC 37° Minimes

Femmina diritta JIC 37°



DN	ROSCA THREAD	Referencia Part n°	
2	7/16" 20h UNF	Z555090700	2

Hembra giratoria Métrica con Junta

Hembra giratoria Métrica con Junta

Embout femelle tournante de control Métrique 24° avec o'ring

Presa di pressione femmina metrica 24° con o'ring



DN	TUBO PIPE	ROSCA THREAD	Referencia Part n°
2	6L	M12X1,5	Z555079510
2	6S	M14X1,5	Z555079511
2	8L	M14X1,5	Z555079512
2	8S	M16X1,5	Z555079523
2	10L	M16X1,5	Z555079525

Instrumentos de medición

Pressure gauges AISI 316 with glycerin

Manomètre AISI 316 avec glycérine

Manometri AISI 316 a bagno di glicerina

Manómetros DN 63 salida vertical

Manómetros DN 63 salida vertical

Manomètre DN 63 sortie verticale

Manometro DN 63 radiale



ROSCA THREAD	ESCALA (bar) SCALE (bar)	Referencia Part n°
1/4" BSP	0-2.5	ZMFI6304002.5V
1/4" BSP	0-4	ZMFI6304004V
1/4" BSP	0-6	ZMFI6304006V
1/4" BSP	0-10	ZMFI6304010V
1/4" BSP	0-16	ZMFI6304016V
1/4" BSP	0-25	ZMFI6304025V
1/4" BSP	0-40	ZMFI6304040V
1/4" BSP	0-60	ZMFI6304060V
1/4" BSP	0-100	ZMFI6304100V
1/4" BSP	0-160	ZMFI6304160V
1/4" BSP	0-250	ZMFI6304250V
1/4" BSP	0-400	ZMFI6304400V
1/4" BSP	0-600	ZMFI6304600V

Manómetros DN 63 dorsal

Manómetros DN 63 dorsal

Manomètre DN 63 sortie arrière

Manometro DN 63 assiale flangiato



ROSCA THREAD	ESCALA (bar) SCALE (bar)	Referencia Part n°
1/4" BSP	0-2.5	ZMFI63042.5DB
1/4" BSP	0-10	ZMFI6304010DB
1/4" BSP	0-16	ZMFI6304016DB
1/4" BSP	0-25	ZMFI6304025DB
1/4" BSP	0-60	ZMFI6304060DB
1/4" BSP	0-160	ZMFI6304160DB
1/4" BSP	0-250	ZMFI6304250DB
1/4" BSP	0-400	ZMFI6304400DB

Manómetros DN 100 salida vertical

Manómetros DN 100 salida vertical

Manomètre DN 100 sortie verticale

Manometro DN 100 radiale



ROSCA THREAD	ESCALA (bar) SCALE (bar)	Referencia Part n°
1/2" BSP	0-6	ZMFI10008006V
1/2" BSP	0-10	ZMFI10008010V
1/2" BSP	0-16	ZMFI10008016V
1/2" BSP	0-25	ZMFI10008025V
1/2" BSP	0-40	ZMFI10008040V
1/2" BSP	0-60	ZMFI10008060V
1/2" BSP	0-100	ZMFI10008100V
1/2" BSP	0-160	ZMFI10008160V
1/2" BSP	0-250	ZMFI10008250V
1/2" BSP	0-400	ZMFI10008400V
1/2" BSP	0-600	ZMFI10008600V

Manómetros DN 100 dorsal

Manómetros DN 100 dorsal

Manomètre DN 100 sortie arrière

Manometro DN 100 assiale flangiato



ROSCA THREAD	ESCALA (bar) SCALE (bar)	Referencia Part n°
1/4" BSP	0-160	ZMFI10004160DB
1/2" BSP	0-1	ZMFI10008001DB
1/2" BSP	0-4	ZMFI10008004DB
1/2" BSP	0-6	ZMFI10008006DB
1/2" BSP	0-10	ZMFI10008010DB
1/2" BSP	0-16	ZMFI10008016DB
1/2" BSP	0-25	ZMFI10008025DB
1/2" BSP	0-40	ZMFI10008040DB
1/2" BSP	0-60	ZMFI10008060DB
1/2" BSP	0-100	ZMFI10008100DB
1/2" BSP	0-160	ZMFI10008160DB
1/2" BSP	0-250	ZMFI10008250DB
1/2" BSP	0-400	ZMFI10008400DB



MANÓMETROS CALIBRADOS BAJO CONSULTA

CALIBRATED MANOMETER ON REQUEST

Instrumentos de medición

Pressure gauges AISI 316 with glycerin
Manomètre AISI 316 avec glycérine
Manometri AISI 316 a bagno di glicerina

Protector manómetro recto

Protector manómetro recto

Isolateur de manomètre droit (en ligne)

Esclusore per manometro diritto



ROSCA THREAD		Referencia Part n°
1/4" BSP	1/4" BSPT	Z FPE 1G 1/4

Protector manómetro 90°

Protector manómetro 90°

Isolateur de manomètre coudé a 90° (en ligne)

Esclusore per manometro a 90°



ROSCA THREAD		Referencia Part n°
1/4" BSP	1/4" BSPT	Z FPEA 1G 1/4

Adaptador para manómetro en línea TL-MF

Adaptador para manómetro en línea TL-MF

Adapteur pour manomètre (en ligne) TL-MF

Esclusore per manometro maschio BSPT - femmina girevole BSP



ROSCA (I/M) THREAD (M)	ROSCA (H) THREAD (F)	Referencia Part n°
1/4" BSP	1/4" BSPT	ZFT229904
1/2" BSP	1/2" BSPT	ZFT229908

CALIDAD para conseguir el mejor RENDIMIENTO.

QUALITY guarantees the BEST PERFORMANCE.

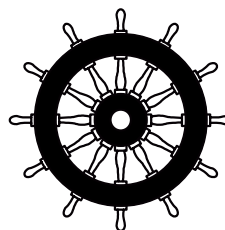

Emisión de certificados. Certificates Issuance.
Certificados de prueba. Test Certificates.
Validación de diseños. Design Validation Tests.
Controles de calidad. Quality Control.

Cortadora de precisión
Precision cutting Saw

Máquina de medición 3D MMC
Machine Measuring by Coordinates (MMC)

Banco de prueba Bimal B1703 Flex
B1703 FLEX Dynamic Test Bench

Banco de prueba Bimal BI1001
Bimal BI1001 Test Bench

Análisis espectrográfico
Spectrographic Analyzer

Banco de pruebas BE 2500 II
BE 2500 II Test Bench

Cámara de niebla salina
Salt-spray chamber

Abrasímetro
Abrasion Tester

Racor Doble Anillo TrΔle® LOK | **267**

Twin Ferrule Fittings TrΔle® LOK

Raccords double bague TrΔle® LOK

Raccordi per doppio anello TrΔle® LOK



10

RACOR DOBLE ANILLO TRΔLE® LOK

Twin Ferrule Fittings TrΔle® LOK

Raccords double bague TrΔle® LOK

Raccordi per doppio anello TrΔle® LOK

CRIMPING FITTINGS
FOR HOSES

Racor Doble Anillo TrΔle® LOK

Twin Ferrule Fittings TrΔle® LOK
Raccords double bague TrΔle® LOK
Raccordi per doppio anello TrΔle® LOK

PIPE
FITTINGS

Tuercas y anillos ▪ Nuts and rings ▪ Écrous et bagues ▪ Dadi e anelli

267



PIPE
FITTINGS II

Uniones tubo-tubo ▪ Straight couplings ▪ Raccords union double ▪ Raccordi intermedi

268



ADAPTORS

Uniones rectas tubo-rosca macho ▪ Straight male stud couplings ▪ Raccords union simple mâle ▪ Raccordi di estremità diritti

270



WELDING
FITTINGS

Codos tubo-rosca ▪ Male stud elbows ▪ Raccords coude mâle gaz ▪ Raccordi di estremità a 90°

271



INDUSTRIAL
FITTINGS

TES rosca central ▪ Male stud branch ▪ Raccords Té mâle central ▪ Raccordi di estremità a T

272



ACCESSORIES

TES rosca lateral ▪ Male stud barrel ▪ Raccords Té mâle latéral ▪ Raccordi di estremità a L

272



CONTROL
COMPONENTS

Pasatabiques ▪ Bulkhead ▪ Raccords passe cloison ▪ Raccordi di attraversamento

272



FLOW
MEASURING

Racor recto hembra ▪ Straight female coupling ▪ Raccords droits femelle ▪ Raccordi diritti con estremità femmina

273



TRALE LOK

Tapones ▪ Plugs ▪ Raccords bouchon métrique ▪ Tappi

274



Racor Doble Anillo TrΔle® LOK

Twin Ferrule Fittings TrΔle® LOK
Raccords double bague TrΔle® LOK
Raccordi per doppio anello TrΔle® LOK

Conectores para tubo ▪ Pipe connector ▪ Connecteur de tuyau ▪ Connettore per tubi

| 274



ZKIA



ZKIAMP



ZKIAHP

TRΔLE® LOK SERIES

INFORMACIÓN DE CODIFICACIÓN / CODIFICATION INFORMATION

1 EJEMPLO- EXAMPLE

ZKTK

ZK: DICSА TRΔLE® LOK SERIES

T: FIGURA (RACOR EN TE)/
FIGURE (TE UNION)

02: Ø Tubo (02 = 1/8")
Ø Tube (02 = 1/8")

2 EJEMPLO- EXAMPLE

ZKIMP0202

ZK: DICSА TRΔLE® LOK SERIES

IM: RACOR RECTO ROSCA TUBO/
STRAIGHT MALE STUD

P02: MACHO 1/8" NPT
MALE 1/8" NPT

02: Ø Tubo (02 = 1/8")
Ø Tube (02 = 1/8")

REF / CODE	DESCRIPCION / DESCRIPTION
ZKN	Tuercas / Nuts
ZKAP	Anillo trasero / Back Ferrule
ZKAF	Anillo frontal / Front Ferrule
ZKI	Unión recta / Straight Union
ZKL	Unión en codo / Elbow Union
ZKT	Unión en T / Tee Union
ZKC	Unión en cruz / Cross Union
ZKIM	Unión recta tubo-rosca / Straight male stud
ZKLMP	Codo tubo - rosca / Male stud elbow
ZKTMP	T tubo - rosca / Male stud T
ZKTLM	L tubo - rosca / Male stud L
ZKIB	Pasatabiques recto / Straight bulkhead
ZKIBP	Pasatabiques tubo-rosca / Male stud bulkhead
ZKIHP	Unión tubo-rosca hembra / Straight female stud
ZKOH	Tapón hembra / Cap
ZKOM	Tapón macho / Plug
ZKIA	Reductor tubo / Pipe Reducer
ZKIAH	Adap. hembra / Female adapter
ZKIMP	Adap macho / Male adapter

DESIGNACIÓN DE TUBO EXTERIOR/ TUBE O.D. DESIGNATOR

TUBO EN PULGADAS / FRACTIONAL TUBE								TUBO MÉTRICO / METRIC TUBE										
1/8"	1/4"	5/16"	3/8"	1/2"	5/8"	3/4"	1"	6	8	10	12	14	15	16	18	20	22	25
02	04	05	06	08	10	12	16	06M	08M	10M	12M	14M	15M	16M	18M	20M	22M	25M



Racor Doble Anillo TrΔle® LOK

Twin Ferrule Fittings TrΔle® LOK
Raccords double bague TrΔle® LOK
Raccordi per doppio anello TrΔle® LOK

Tuercas para doble anillo

Nut for twin-ferrule

Écrou double bagues

Dado per doppia ghiera



TUBO PIPE	Referencia Part n°
1/8"	ZKN02
1/4"	ZKN04
5/16"	ZKN05
3/8"	ZKN06
1/2"	ZKN08
5/8"	ZKN10
3/4"	ZKN12
1"	ZKN16
6	ZKN06M
8	ZKN08M
10	ZKN10M
12	ZKN12M
14	ZKN14M
15	ZKN15M
16	ZKN16M
18	ZKN18M
20	ZKN20M
22	ZKN22M
25	ZKN25M

Anillo frontal

Front Ferrule

Bague avant

Ghiera frontale



TUBO PIPE	Referencia Part n°
1/8"	ZKAF02
1/4"	ZKAF04
5/16"	ZKAF05
3/8"	ZKAF06
1/2"	ZKAF08
5/8"	ZKAF10
3/4"	ZKAF12
1"	ZKAF16
6	ZKAF06M
8	ZKAF08M
10	ZKAF10M
12	ZKAF12M
14	ZKAF14M
15	ZKAF15M
16	ZKAF16M
18	ZKAF18M
20	ZKAF20M
22	ZKAF22M
25	ZKAF25M

Anillo posterior

Back Ferrule

Bague arrière

Indietro ghiera



TUBO PIPE	Referencia Part n°
1/8"	ZKAP02
1/4"	ZKAP04
5/16"	ZKAP05
3/8"	ZKAP06
1/2"	ZKAP08
5/8"	ZKAP10
3/4"	ZKAP12
1"	ZKAP16
6	ZKAP06M
8	ZKAP08M
10	ZKAP10M
12	ZKAP12M
14	ZKAP14M
15	ZKAP15M
16	ZKAP16M
18	ZKAP18M
20	ZKAP20M
22	ZKAP22M
25	ZKAP25M

Racor Doble Anillo TrAle® LOK

Twin Ferrule Fittings TrAle® LOK
Raccords double bague TrAle® LOK
Raccordi per doppio anello TrAle® LOK

Racor unión recta tubo - tubo

Double Straight coupling

Raccord union double

Raccordo intermedio diritto



TUBO PIPE	Referencia Part n°
1/8"	ZKI02
1/4"	ZKI04
5/16"	ZKI05
3/8"	ZKI06
1/2"	ZKI08
5/8"	ZKI10
3/4"	ZKI12
1"	ZKI16
6	ZKI06M
8	ZKI08M
10	ZKI10M
12	ZKI12M
14	ZKI14M
15	ZKI15M
16	ZKI16M
18	ZKI18M
20	ZKI20M
22	ZKI22M
25	ZKI25M

Racor unión recta en reducción tubo - tubo

Straight reducing coupling

Raccord union double en réduction

Raccordo di riduzione



TUBO PIPE	TUBO PIPE	Referencia Part n°
1/4"	1/8"	ZKI0402
5/16"	1/4"	ZKI0504
3/8"	1/8"	ZKI0602
3/8"	1/4"	ZKI0604
1/2"	1/4"	ZKI0804
1/2"	3/8"	ZKI0806
5/8"	3/8"	ZKI1006
5/8"	1/2"	ZKI1008
3/4"	1/4"	ZKI1204
3/4"	3/8"	ZKI1206
3/4"	1/2"	ZKI1208
1"	1/2"	ZKI1608
1"	3/4"	ZKI1612
6	3	ZKI06M03M
8	6	ZKI08M06M
10	6	ZKI10M06M
10	8	ZKI10M08M
12	6	ZKI12M06M
12	8	ZKI12M08M
12	10	ZKI12M10M
16	12	ZKI16M12M
18	12	ZKI18M12M
25	18	ZKI25M18M
25	20	ZKI25M20M

Racor unión en codo tubo - tubo

Equal elbow coupling

Raccord coude égal

Raccordo intermedio a 90°



TUBO PIPE	Referencia Part n°
1/8"	ZKL02
1/4"	ZKL04
5/16"	ZKL05
3/8"	ZKL06
1/2"	ZKL08
5/8"	ZKL10
3/4"	ZKL12
1"	ZKL16
6	ZKL06M
8	ZKL08M
10	ZKL10M
12	ZKL12M
14	ZKL14M
15	ZKL15M
16	ZKL16M
18	ZKL18M
20	ZKL20M
22	ZKL22M
25	ZKL25M

Racor unión en T tubo - tubo

Equal Tee

Raccord Té égal

Raccordo intermedio a T



TUBO PIPE	Referencia Part n°
1/8"	ZKT02
1/4"	ZKT04
5/16"	ZKT05
3/8"	ZKT06
1/2"	ZKT08
5/8"	ZKT10
3/4"	ZKT12
1"	ZKT16
6	ZKT06M
8	ZKT08M
10	ZKT10M
12	ZKT12M
14	ZKT14M
15	ZKT15M
16	ZKT16M
18	ZKT18M
20	ZKT20M
22	ZKT22M
25	ZKT25M

Racor Doble Anillo TrΔle® LOK

Twin Ferrule Fittings TrΔle® LOK
 Raccords double bague TrΔle® LOK
 Raccordi per doppio anello TrΔle® LOK

Racor unión en cruz tubo - tubo

Equal cross

Raccord croix égale

Raccordo intermedio a croce



TUBO PIPE	Referencia Part n°
1/8"	ZKC02
1/4"	ZKC04
5/16"	ZKC05
3/8"	ZKC06
1/2"	ZKC08
6	ZKC06M
8	ZKC08M
10	ZKC10M
12	ZKC12M

■ TrΔle® Lok SERIES

Conexión libre de fugas
 Apta para entornos agresivos

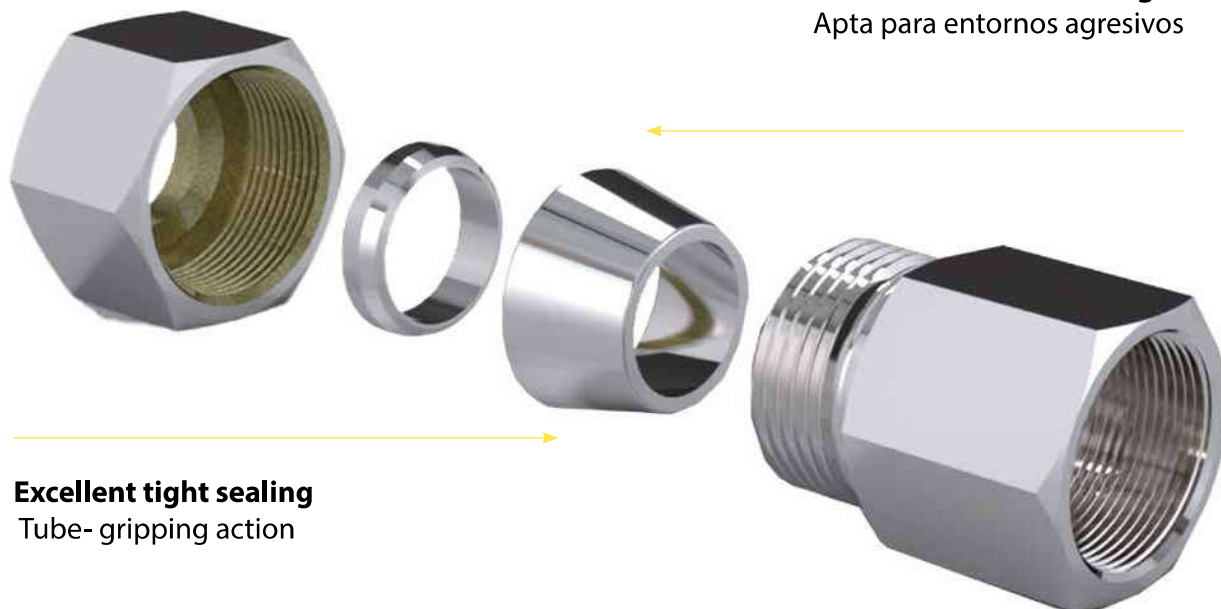

Excellent tight sealing
 Tube- gripping action

CRIMPING FITTINGS
FOR HOSES

PIPE
FITTINGS

PIPE
FITTINGS II

ADAPTORS

WELDING
FITTINGS

INDUSTRIAL
FITTINGS

ACCESSORIES

CONTROL
COMPONENTS

FLOW
MEASURING

TRALE LOK

Racor Doble Anillo TrΔle® LOK

Twin Ferrule Fittings TrΔle® LOK
Raccords double bague TrΔle® LOK
Raccordi per doppio anello TrΔle® LOK

Racor recto rosca cónica NPT

Straight male stud coupling NPT

Raccord union simple mâle NPT

Raccordo di estremità diritto NPT



Racor recto rosca cónica BSPT

Straight male stud coupling BSPT

Raccord union simple mâle conique BSPT

Raccordo di estremità diritto conico BSPT



TUBO PIPE	ROSCA THREAD	Referencia Part n°
1/16"	1/8"	ZKIMP0102
1/8"	1/16"	ZKIMP0201
1/8"	1/8"	ZKIMP0202
1/8"	1/4"	ZKIMP0204
1/8"	3/8"	ZKIMP0206
1/8"	1/2"	ZKIMP0208
1/4"	1/8"	ZKIMP0402
1/4"	1/4"	ZKIMP0404
1/4"	3/8"	ZKIMP0406
1/4"	1/2"	ZKIMP0408
3/8"	1/8"	ZKIMP0602
3/8"	1/4"	ZKIMP0604
3/8"	3/8"	ZKIMP0606
3/8"	1/2"	ZKIMP0608
3/8"	3/4"	ZKIMP0612
3/8"	1"	ZKIMP0616
1/2"	1/8"	ZKIMP0802
1/2"	1/4"	ZKIMP0804
1/2"	3/8"	ZKIMP0806
1/2"	1/2"	ZKIMP0808
1/2"	3/4"	ZKIMP0812
3/4"	3/8"	ZKIMP1206
3/4"	1/2"	ZKIMP1208
3/4"	3/4"	ZKIMP1212
3/4"	1/4"	ZKIMP1216
1"	1/2"	ZKIMP1608
1"	3/4"	ZKIMP1612
1"	1"	ZKIMP1616
6	1/8"	ZKIMP06M02
6	1/4"	ZKIMP06M04
6	3/8"	ZKIMP06M06
6	1/2"	ZKIMP06M08
8	1/8"	ZKIMP08M02
8	1/4"	ZKIMP08M04
8	3/8"	ZKIMP08M06
8	1/2"	ZKIMP08M08
10	1/8"	ZKIMP10M02
10	1/4"	ZKIMP10M04
10	3/8"	ZKIMP10M06
10	1/2"	ZKIMP10M08
12	1/4"	ZKIMP12M04
12	3/8"	ZKIMP12M06
12	1/2"	ZKIMP12M08
12	3/4"	ZKIMP12M12
12	1/4"	ZKIMP12M04
12	3/8"	ZKIMP12M06
12	1/2"	ZKIMP12M08
14	3/8"	ZKIMP14M06
14	1/2"	ZKIMP14M08
15	1/2"	ZKIMP15M08
16	1/4"	ZKIMP16M04
16	3/8"	ZKIMP16M06
16	1/2"	ZKIMP16M08
16	3/4"	ZKIMP16M12
18	1/2"	ZKIMP18M08
18	3/4"	ZKIMP18M12
22	3/4"	ZKIMP22M12
22	1"	ZKIMP22M16
25	1/2"	ZKIMP25M08
25	3/4"	ZKIMP25M12
25	1"	ZKIMP25M16

TUBO PIPE	ROSCA THREAD	Referencia Part n°
1/8	1/8"	ZKIM0202
1/8	1/4"	ZKIM0204
1/4"	1/8"	ZKIM0402
1/4"	1/4"	ZKIM0404
1/4"	3/8"	ZKIM0406
1/4"	1/2"	ZKIM0408
3/8"	1/8"	ZKIM0602
3/8"	1/4"	ZKIM0604
3/8"	3/8"	ZKIM0606
3/8"	1/2"	ZKIM0608
3/8"	3/4"	ZKIM0612
1/2"	1/4"	ZKIM0804
5/8"	1/2"	NEW ZKIM1008
1/2"	3/8"	ZKIM0806
1/2"	1/2"	ZKIM0808
1/2"	3/4"	ZKIM0812
3/4"	3/4"	ZKIM1212
3/4"	1"	ZKIM1216
1"	3/4"	ZKIM1612
6	1/8"	ZKIM06M02
6	1/4"	ZKIM06M04
6	3/8"	ZKIM06M06
6	1/2"	ZKIM06M08
8	1/8"	ZKIM08M02
8	1/4"	ZKIM08M04
8	3/8"	ZKIM08M06
8	1/2"	ZKIM08M08
10	1/8"	ZKIM10M02
10	1/4"	ZKIM10M04
10	3/8"	ZKIM10M06
10	1/2"	ZKIM10M08
12	1/4"	NEW ZKIM12M04
12	3/8"	ZKIM12M06
12	1/2"	ZKIM12M08
16	1/4"	ZKIM16M04
16	3/8"	ZKIM16M06
16	1/2"	ZKIM16M08
16	3/4"	ZKIM16M12
18	1/2"	ZKIM18M08
18	3/4"	ZKIM18M12
22	3/4"	ZKIM22M12
22	1"	ZKIM22M16
25	3/4"	ZKIM25M12
25	1"	ZKIM25M16
25	1/2"	ZKIM25M08

Racor Doble Anillo TrΔle® LOK

Twin Ferrule Fittings TrΔle® LOK
Raccords double bague TrΔle® LOK
Raccordi per doppio anello TrΔle® LOK

Racor en codo rosca cónica NPT

Male stud elbow NPT

Raccord union coude mâle NPT

Raccordo di estremità a 90° NPT



TUBO PIPE	ROSCA THREAD	Referencia Part n°
1/8"	1/8"	ZKLMP0202
1/8"	1/4"	ZKLMP0204
1/8"	3/8"	ZKLMP0206
1/4"	1/8"	ZKLMP0402
1/4"	1/4"	ZKLMP0404
1/4"	3/8"	ZKLMP0406
1/4"	1/2"	ZKLMP0408
3/8"	1/8"	ZKLMP0602
3/8"	1/4"	ZKLMP0604
3/8"	3/8"	ZKLMP0606
3/8"	1/2"	ZKLMP0608
3/8"	3/4"	ZKLMP0612
1/2"	1/4"	ZKLMP0804
1/2"	3/8"	ZKLMP0806
1/2"	1/2"	ZKLMP0808
3/4"	1/2"	ZKLMP1208
3/4"	3/4"	ZKLMP1212
1"	3/4"	ZKLMP1612
1"	1"	ZKLMP1616
16	1/4"	ZKLMP16M04
16	3/8"	ZKLMP16M06
6	1/8"	ZKLMP06M02
6	1/4"	ZKLMP06M04
16	1/2"	ZKLMP16M08
16	3/4"	ZKLMP16M12
6	3/8"	ZKLMP06M06
6	1/2"	ZKLMP06M08
8	1/8"	ZKLMP08M02
8	1/4"	ZKLMP08M04
8	3/8"	ZKLMP08M06
8	1/2"	ZKLMP08M08
10	1/8"	ZKLMP10M02
10	1/4"	ZKLMP10M04
10	3/8"	ZKLMP10M06
10	1/2"	ZKLMP10M08
12	1/4"	ZKLMP12M04
12	3/8"	ZKLMP12M06
12	1/2"	ZKLMP12M08
12	3/4"	ZKLMP12M12
18	1/2"	ZKLMP18M08
18	3/4"	ZKLMP18M12
22	3/4"	ZKLMP22M12
22	1"	ZKLMP22M16
25	3/4"	ZKLMP25M12
25	1"	ZKLMP25M16

Racor en codo rosca cónica BSPT

Male stud elbow BSPT

Raccord union coude mâle gaz conique

Raccordo di estremità a 90° conico BSPT



TUBO PIPE	ROSCA THREAD	Referencia Part n°
1/4"	1/8"	ZKLM0402
1/4"	1/4"	ZKLM0404
1/4"	3/8"	ZKLM0406
1/4"	1/2"	ZKLM0408
3/8"	1/4"	ZKLM0604
3/8"	3/8"	ZKLM0606
3/8"	1/2"	ZKLM0608
1/2"	1/4"	ZKLM0804
1/2"	3/8"	ZKLM0806
1/2"	1/2"	ZKLM0808
6	1/4"	ZKLM06M04
6	1/2"	ZKLM06M08
8	1/8"	ZKLM08M02
8	1/4"	ZKLM08M04
8	3/8"	ZKLM08M06
8	1/2"	ZKLM08M08
10	1/8"	ZKLM10M02
10	1/4"	ZKLM10M04
10	3/8"	ZKLM10M06
10	1/2"	ZKLM10M08
12	1/4"	ZKLM12M04
12	3/8"	ZKLM12M06
12	1/2"	ZKLM12M08
16	1/4"	ZKLM16M04
16	3/8"	ZKLM16M06
16	1/2"	ZKLM16M08
16	3/4"	ZKLM16M12
22	3/4"	ZKLM22M12
22	1"	ZKLM22M16

Racor Doble Anillo TrΔle® LOK

Twin Ferrule Fittings TrΔle® LOK
Raccords double bague TrΔle® LOK
Raccordi per doppio anello TrΔle® LOK

Racor en T rosca cónica NPT

Male stud branch TEE NPT

Raccord TÉ mâle NPT au centre

Raccordo di estremità a T NPT



TUBO PIPE	ROSCA THREAD	Referencia Part n°
1/8"	1/8"	ZKTMP0202
1/8"	1/4"	ZKTMP0204
1/4"	1/8"	ZKTMP0402
1/4"	1/4"	ZKTMP0404
3/8"	1/4"	ZKTMP0604
3/8"	3/8"	ZKTMP0606
1/2"	3/8"	ZKTMP0806
1/2"	1/2"	ZKTMP0808
6	1/8"	ZKTMP06M02
6	1/4"	ZKTMP06M04
8	1/8"	ZKTMP08M02
8	1/4"	ZKTMP08M04
10	1/4"	ZKTMP10M04
10	3/8"	ZKTMP10M06
12	1/4"	ZKTMP12M04
12	3/8"	ZKTMP12M06
12	1/2"	ZKTMP12M08

Racor en L rosca cónica NPT

Male stud barrel TEE NPT

Raccord Té mâle NPT latéral Inox

Raccordo di estremità a L NPT conico



TUBO PIPE	ROSCA THREAD	Referencia Part n°
1/8"	1/8"	ZKTLMP0202
1/8"	1/4"	ZKTLMP0204
1/4"	1/8"	ZKTLMP0402
1/4"	1/4"	ZKTLMP0404
3/8"	1/4"	ZKTLMP0604
3/8"	3/8"	ZKTLMP0606
1/2"	3/8"	ZKTLMP0806
1/2"	1/2"	ZKTLMP0808
6	1/8"	ZKTLMP06M02
6	1/4"	ZKTLMP06M04
8	1/8"	ZKTLMP08M02
8	1/4"	ZKTLMP08M04
10	1/4"	ZKTLMP10M04
10	1/2"	ZKTLMP10M08
12	1/4"	ZKTLMP12M04
12	3/8"	ZKTLMP12M06
12	1/2"	ZKTLMP12M08

Racor recto pasatabique con tuerca

Straight bulkhead coupling

Raccord droit union double passe cloison avec écrou

Raccordo passaparete



TUBO PIPE	Referencia Part n°
1/8"	ZKIB02
1/4"	ZKIB04
5/16"	ZKIB05
3/8"	ZKIB06
1/2"	ZKIB08
5/8"	ZKIB10
3/4"	ZKIB12
1"	ZKIB16
6	ZKIB06M
8	ZKIB08M
10	ZKIB10M
12	ZKIB12M
15	ZKIB15M
16	ZKIB16M
18	ZKIB18M
20	ZKIB20M
25	ZKIB25M

Racor recto - NPT pasatabique con tuerca

Straight bulkhead coupling- NPT

Raccord droit union double passe cloison avec écrou - NPT

Raccordo passaparete - NPT

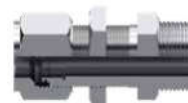

TUBO PIPE	ROSCA THREAD	Referencia Part n°
1/8"	1/8"	ZKIBP0202
1/4"	1/4"	ZKIBP0404
3/8"	3/8"	ZKIBP0606
1/2"	1/2"	ZKIBP0808
3/4"	3/4"	ZKIBP1212
1"	1"	ZKIBP1616
6	1/8"	ZKIBP06M02
8	1/4"	ZKIBP08M04
10	3/8"	ZKIBP10M06
12	1/2"	ZKIBP12M08

Racor Doble Anillo TrΔle® LOK

Twin Ferrule Fittings TrΔle® LOK
Raccords double bague TrΔle® LOK
Raccordi per doppio anello TrΔle® LOK

Racor recto hembra rosca NPT

Female stud coupling NPT

Raccord union simple femelle NPT

Raccordo diritto femmina NPT



TUBO PIPE	ROSCA THREAD	Referencia Part n°
1/8"	1/8"	ZKIHP0202
1/8"	1/4"	ZKIHP0204
1/8"	3/8"	ZKIHP0206
1/8"	1/2"	ZKIHP0208
1/4"	1/8"	ZKIHP0402
1/4"	1/4"	ZKIHP0404
1/4"	3/8"	ZKIHP0406
1/4"	1/2"	ZKIHP0408
3/8"	1/8"	ZKIHP0602
3/8"	1/4"	ZKIHP0604
3/8"	3/8"	ZKIHP0606
3/8"	1/2"	ZKIHP0608
3/8"	3/4"	ZKIHP0612
1/2"	1/8"	ZKIHP0802
1/2"	1/4"	ZKIHP0804
1/2"	3/8"	ZKIHP0806
1/2"	1/2"	ZKIHP0808
5/8"	1/2"	ZKIHP1008
3/4"	1/2"	ZKIHP1208
3/4"	3/4"	ZKIHP1212
1"	3/4"	ZKIHP1612
1"	1"	ZKIHP1616
6	1/8"	ZKIHP06M02
6	1/4"	ZKIHP06M04
6	3/8"	ZKIHP06M06
6	1/2"	ZKIHP06M08
8	1/8"	ZKIHP08M02
8	1/4"	ZKIHP08M04
8	3/8"	ZKIHP08M06
8	1/2"	ZKIHP08M08
10	1/4"	ZKIHP10M04
10	3/8"	ZKIHP10M06
10	1/2"	ZKIHP10M08
12	1/4"	ZKIHP12M04
12	3/8"	ZKIHP12M06
12	1/2"	ZKIHP12M08
16	1/2"	ZKIHP16M08
20	3/4"	ZKIHP20M12
22	3/4"	ZKIHP22M12
25	3/4"	ZKIHP25M12
25	1"	ZKIHP25M16
2"	2"	ZKIHP3232

Racor recto hembra rosca BSPT

Female stud coupling BSPT

Raccord union simple femelle BSPT

Raccordo diritto femmina BSPT



TUBO PIPE	ROSCA THREAD	Referencia Part n°
1/4"	1/4"	ZKIHP0404
1/2"	1/4"	ZKIHP0804
1/2"	1/2"	ZKIHP0808
6	1/8"	ZKIHP06M02
6	1/4"	ZKIHP06M04
8	1/4"	ZKIHP08M04
8	1/2"	ZKIHP08M08
10	1/4"	ZKIHP10M04
20	3/4"	ZKIHP20M12



Válvulas de instrumentación

Válvulas de aguja, Manifold, Antirretornos y Válvulas limitadoras de presión

BAJO CONSULTA

Instrument Valve

Needle Valve, Manifold, Check and Proportional Relief Valve

ON REQUEST

CRIMPING FITTINGS
FOR HOSES

PIPE
FITTINGS

PIPE
FITTINGS II

ADAPTORS

WELDING
FITTINGS

INDUSTRIAL
FITTINGS

ACCESSORIES

CONTROL
COMPONENTS

FLOW
MEASURING

TRALE LOK

Racor Doble Anillo TrΔle® LOK

Twin Ferrule Fittings TrΔle® LOK
Raccords double bague TrΔle® LOK
Raccordi per doppio anello TrΔle® LOK

Tapón de cierre hembra UNF

UNF plug closure

Bouchon de fermeture Femelle UNF

Tappo di chiusura femmina UNF



TUBO PIPE	Referencia Part n°
1/8"	ZKOH02
1/4"	ZKOH04
5/16"	ZKOH05
3/8"	ZKOH06
1/2"	ZKOH08
5/8"	ZKOH10
3/4"	ZKOH12
1"	ZKOH16
6	ZKOH06M
8	ZKOH08M
10	ZKOH10M
12	ZKOH12M
14	ZKOH14M
15	ZKOH15M
16	ZKOH16M
18	ZKOH18M
20	ZKOH20M
22	ZKOH22M
25	ZKOH25M

Tapón hexagonal macho UNF

UNF cap hexagon

Bouchon mâle hexagonale UNF

Tappo esagonale maschio UNF



TUBO PIPE	Referencia Part n°
1/8"	ZKOM02
1/4"	ZKOM04
5/16"	ZKOM05
3/8"	ZKOM06
1/2"	ZKOM08
5/8"	ZKOM10
3/4"	ZKOM12
1"	ZKOM16
6	ZKOM06M
8	ZKOM08M
10	ZKOM10M
12	ZKOM12M
14	ZKOM14M
15	ZKOM15M
16	ZKOM16M
18	ZKOM18M
20	ZKOM20M
22	ZKOM22M
25	ZKOM25M

Racor de Reducción tubo

Tube end reducer

Raccord de réduction

Raccordo di riduzione tubo



TUBO PIPE	Referencia Part n°
1/4"	ZKIA0402
3/8"	ZKIA0604
1/2"	ZKIA0806
3/4"	ZKIA1208
8	ZKIA08M06M
10	ZKIA10M08M
12	ZKIA12M10M
16	ZKIA16M12M

Adaptador macho NPT

Male NPT adaptor

Adapteur Mâle NPT

Adattatore NPT maschio



TUBO PIPE	ROSCA THREAD	Referencia Part n°
1/8"	1/8"	ZKIAMP0202
1/4"	1/4"	ZKIAMP0404
3/8"	3/8"	ZKIAMP0606
1/2"	1/2"	ZKIAMP0808
6	1/8"	ZKIAMP06M02
8	1/4"	ZKIAMP08M04
10	1/4"	ZKIAMP10M04
10	3/8"	ZKIAMP10M06
10	1/2"	ZKIAMP10M08
12	1/2"	ZKIAMP12M08

Adaptador hembra NPT

Female NPT adaptor

Adapteur Femelle NPT

Adattatore NPT femmina



TUBO PIPE	ROSCA THREAD	Referencia Part n°
1/8"	1/8"	ZKIAHP0202
1/4"	1/4"	ZKIAHP0404
3/8"	3/8"	ZKIAHP0606
1/2"	1/2"	ZKIAHP0808
6	1/8"	ZKIAHP06M02
8	1/4"	ZKIAHP08M04
10	3/8"	ZKIAHP10M06
12	1/2"	ZKIAHP12M08

Condiciones de venta

General conditions of sale

GENERALIDADES

Estas condiciones así como las eventuales condiciones especiales acordadas en el contrato rigen para todas las entregas y todas las prestaciones. Las condiciones de compra del cliente que sean distintas a las aquí establecidas no llegarán a formar parte del contrato al aceptar el pedido. Los contratos se celebran, salvo en el caso de que se haya acordado lo contrario, mediante confirmación escrita del proveedor. En ningún caso, las Condiciones Generales y/o Específicas de Compra del Comprador, anularán o sustituirán estas Condiciones Generales de Venta.

La aceptación de nuestras ofertas implica tácitamente la de todas las condiciones aquí detalladas, salvo las especiales acordadas por escrito, particularmente en la misma Oferta o detalladas en nuestro acuse de recepción de pedido, únicos documentos que nos obligan ante el Cliente.

fluidal se reserva el derecho de propiedad y el derecho de propiedad intelectual de muestras, presupuestos, planos e información en forma material o inmaterial así como en forma electrónica; el acceso de terceros a éstos ha de impedirse.

OFERTAS Y PEDIDOS

Los precios se entienden, caso de no expresar lo contrario para mercadería situada en nuestro almacén, incluyendo el cargado de ésta, pero sin incluir el embalaje ni el transporte al lugar de recepción, ni impuestos –que serán siempre a cargo del comprador–, así como tampoco la puesta en marcha en el emplazamiento. Todas las operaciones de transporte, seguro, manutención y entrega son a cuenta y riesgo del Comprador.

Las ofertas incluyen solamente los materiales y artículos en ellas especificados disponibles en stock salvo agotamiento y por el plazo de validez determinado en las mismas.

Los estudios u ofertas de material están basados en los precios vigentes en la fecha de su realización, y si, debido a alteraciones en el coste de los materiales, modificación de aranceles o a cualquier otra causa, el nivel de precios fuese revisado, los precios que se aplicarían serían aquellos que rijan en la fecha del suministro, a menos que la oferta sea aceptada dentro del plazo de validez que en la misma se fije.

Los precios no incluyen, excepto notificación expresa, el montaje y la puesta en marcha de los materiales suministrados, los fluidos recomendados por los servicios técnicos de los fabricantes, los contenedores tanto rígidos como elásticos de los materiales, así como el estudio de implantación de los distintos materiales.

fluidal podrá variar el precio, como consecuencia de cualquier ley que afecte a materiales, salarios o a las horas de trabajo y también a posible cambios en la paridad de la moneda, en elementos de importación.

Los pedidos no serán tomados en consideración a menos que vengan acompañados de la cantidad a cuenta prevista en nuestra Oferta, si así se ha establecido.

La aceptación de la Oferta supondrá igualmente la aceptación sin reservas de estas Condiciones Generales de Venta.

ESTUDIOS, PLANOS Y DISEÑOS

La información relacionada con la oferta, tal como planos, diseños, dibujos catálogos y/u otra documentación técnica, es solamente informativa y tienen como objeto dar una imagen general de los materiales en ellos descritos, no formando parte del contrato a menos que haya habido algún acuerdo por escrito. fluidal no aceptará ningún tipo de responsabilidad por la inexactitud u omisión de dicha documentación.

El Cliente deberá hacer siempre un estudio previo de compatibilidad y de montaje de los elementos en su instalación y será el único responsable de la puesta en conformidad de dicha instalación con las distintas reglamentaciones vigentes.

En presupuestos, planos, esquemas y otras informaciones técnicas, mantendremos reservado el derecho de propiedad y de realización, no permitiendo que estos sean facilitados a terceros sin nuestro previo consentimiento escrito.

fluidal se reserva el derecho de propiedad de la mercancía suministrada hasta el pago completo del precio establecido. fluidal se reserva el derecho de propiedad de los planos de la mercancía, que no serán facilitados ni vendidos a terceros en ningún caso.

TRABAJOS IN SITU

Los presupuestos de los trabajos realizados en el lugar de la obra del cliente son considerados orientativos, debido a las características particulares y especiales que pueden representar, no pudiendo dar lugar, excepto acuerdo definitivo entre las partes, en precios definitivos.

REPARACIÓN

Los trabajos de reparación no se empezarán hasta la aceptación escrita, por parte del Cliente, del presupuesto y de las condiciones que se establezcan.

En el supuesto de que el presupuesto no sea aceptado por el Cliente en el plazo de un mes, los gastos derivados del desmontaje, almacenaje, peritaje y portes correrán a cargo del Cliente. Si el Cliente solicita la reparación antes de aceptar el presupuesto, los trabajos se llevarán a cabo lo antes posible y, por su parte, el Cliente deberá aceptar el coste final de la reparación.

GENERAL TERMS

These conditions, together with the eventual specific conditions accorded in the contract, apply to all deliveries and all services. The purchase conditions of the customer, if different from those herein established, will not be part of the contract on having accepted the order.

The contracts are concluded, unless otherwise agreed upon by the Parties in writing, by means of written confirmation of the supplier. The General Conditions and / or Specific Conditions of Purchase of the Buyer, cannot, in no case, cancel or replace these General Conditions of Sale.

The acceptance of our offers implies tacitly the acceptance of all the conditions detailed herein, except the special ones that have the agreement in writing, particularly in the same offer or detailed in our accuse of receipt of order, the only documents that oblige us before the Customer. fluidal has the right of property and the right of intellectual property of samples, budgets, technical documentation and information in material or immaterial form as well as in electronic form; the access of third parties to these documents must be forbidden.

OFFERS AND ORDERS

Except in case of having expressed the opposite, the prices include the merchandise placed in our store, including its loading, but without including the packing nor the transport to the place of receipt, nor taxes, nor the getting started - these will always be at the expense of the customer. All the operations of transport, insurance, handling and delivery are on the account and risk of the Customer.

The offers include only the materials and products expressed in them, available in stock until end of stock, with the term of validity expressed in the same offers.

The studies or offers of material are based on the prices on the date the offer was made, and if, due to changes in the cost of the materials, modification of duties or to any other reason, the level of prices was checked, the prices that would be applied would be those that apply in the date of the delivery, unless the offer is accepted in the term of validity expressed in it.

The prices do not include, unless specific notification, the assembly and the getting started of the supplied materials, the fluids recommended by the technical services of the suppliers, the containers of the materials, as well as the study of the setting up of the different materials. fluidal may change the price, as a consequence of any law that concerns materials, wages, or the working hours, but also as a consequence of probable changes in the parity of the currency since it concerns the elements of import.

The orders will not be taken in consideration unless they are provided with the specific amount in our account, foreseen in our Offer, if this condition has been pre-established. The acceptance of the Offer will suppose equally the acceptance without reserve of these General Conditions of Sale.

STUDIES, TECHNICAL DOCUMENTATION

The information related to the offer, as technical documentation, designs, drawings, catalogues and / or any other technical documentation, is only informative and they have as object to give a general image of the materials described in them, they do not form a part of the contract unless written agreement. fluidal will not accept any type of responsibility for inaccuracy or omission of the above mentioned documentation.

The Customer will always have to do a previous study of compatibility and of assembly of the elements in his installation and will be the only responsible for the putting in conformity of the above mentioned installation with the current regulations. In offers, drawings, schemes and other technical information, we reserve ourselves the right of property and of design, not allowing that these should be facilitated to third parties without our previous written assent.

fluidal retains the property of the supplied merchandise until full payment of the agreed price. fluidal also retains the property of the Product's project, which in no circumstances shall be disclosed or sold to third parties.

THE ASSEMBLIES AT THE LOCATION (PLANT) OF THE CUSTOMER

The offers of the assemblies done for the customer, in his elected location of work, are considered as an estimate (approximate calculation), due to the particular and special characteristics that they can represent, not being able to give place, except final agreement between the parts, to final prices.

REPAIRMENT

The works of repair will not begin until written acceptance, on the part of the Customer, of the offer and of the conditions established in it. Supposing that the offer is not accepted by the Customer within one month, the expenses derived from the disassembly, storage, survey and freightage will be chargeable to the Customer. If the Customer requests the repair before accepting the offer, the assemblies will be carried out as soon as possible and, for his part, the Customer will have to accept the final cost of the repair.

In case of delivery of new products in exchange for the repair, if this one was out of guarantee, the Customer will have to accept the payment corresponding to it. The budgets of repair are always as estimation and should not be considered as final prices.

Condiciones de venta

General conditions of sale

En caso de entregarse productos nuevos a cambio de la reparación, si esta estuviera fuera de garantía el Cliente deberá aceptar el cargo correspondiente a la misma.

Los presupuestos de reparación siempre son orientativos y en ningún caso deben tomarse como precios finales.

PLAZOS DE ENTREGA

fluidal se reserva la facultad de rechazar un pedido en función de la disponibilidad de los productos. En este supuesto, lo comunicara al comprador con la mayor brevedad posible.

El plazo de entrega será acordado por las partes contractuales. Los plazos de entrega se calcularán desde la fecha de recepción de la confirmación del pedido, pudiendo fluidal proceder sin interrupción alguna. fluidal no será responsable de las demoras en el suministro de toda o parte de la mercancía en el caso de fuerza mayor, tal como catástrofes naturales, limitaciones legales, huelgas, etc., o cualquier otra causa fuera de nuestro control. En el caso de darse alguna de las razones anteriormente citadas, el periodo de entrega se hará extensible al mismo período de tiempo que dure la causa que haya motivado el retraso. Sin embargo, si el período excediera de seis meses, fluidal podrá cancelar la parte no enviada notificando previamente por escrito al comprador.

Procuramos con el mayor interés, cumplir los plazos de entrega que se indican en nuestras ofertas o en nuestras confirmaciones de pedido, si bien es materialmente imposible responder plenamente de dicho cumplimiento, por depender de otros proveedores y de inesperadas circunstancias totalmente ajenas a nuestro posible control.

De ahí que no se aceptarán sanciones por demora en la entrega prevista.

DERECHO DE PROPIEDAD

fluidal mantiene la propiedad de la mercancía hasta que el comprador realice el pago por completo de la misma.

Será responsabilidad del comprador tomar las medidas necesarias para conservar en buen estado la mercancía hasta que haya sido pagada, debiendo asegurarse a fluidal el cobro de la misma en caso de haber sido vendida a terceras personas por el comprador.

GARANTÍA

No se responderá de ninguna reclamación que no sea efectuada dentro de los 12 meses siguientes a la entrega de la mercancía, ni se aceptarán devoluciones sin autorización previa o pasados 15 días desde la entrega de la mercancía. En cualquier caso, toda devolución deberá ir acompañada de copia de nuestra autorización y, siempre que no sea por causas imputables a fluidal, conllevará un recargo mínimo del 20 % sobre el coste del material devuelto, corriendo todos los gastos a cargo del cliente.

En relación con los defectos que aparezcan en los productos suministrados, fluidal aceptará como única responsabilidad u obligación, abonar la pieza o piezas defectuosas siempre que la mercancía haya sido tratada adecuadamente y que los defectos surgidos sean debidos a defectos de material o fabricación.

La garantía comprende la reposición o reparación de los elementos defectuosos a realizar en nuestros talleres.

La garantía se entiende siempre con el material presumiblemente defectuoso depositado en nuestras instalaciones, con los gastos de transporte y riesgo a cargo del comprador.

Los consejos y asesoramiento dados antes y post cierre del contrato, se realizan con la mejor intención y según nuestros máximos conocimientos, no obstante fluidal no asume ninguna clase de responsabilidades a este respecto, ni responderá de los eventuales daños directos o indirectos que indistintamente, por quién, dónde y por qué puedan producirse.

fluidal no será responsable de ninguna consecuencia o ningún daño indirecto producido al Comprador o a terceros, incluyendo los daños de pérdida de oportunidades, negocio o ingresos.

fluidal garantiza exclusivamente sus materiales excluyendo cualquier responsabilidad por los efectos o perjuicios que estos puedan provocar en instalaciones, maquinarias o circuitos. En ningún caso se responsabilizará de los accidentes personales o materiales y pérdidas de producción.

Se excluye de la garantía las averías producidas por mal uso o deficiente instalación, averías provocadas por sometimiento de los equipos a esfuerzos anormales con fines experimentales, de ajuste o prueba. La total responsabilidad de fluidal por los daños causados, independientemente del tipo de acción o teoría de la responsabilidad, no excederá del importe de la obra, instalación o materiales que haya sido objeto de pedido a fluidal. Cualquier importe que supere dicha cantidad y que fluidal se vea obligada a soportar ya sea por decisión judicial, arbitral o similar, será repetida a la compradora hasta lograr indemnidad.

Se encuentran excluidos de esta garantía:

- El uso de instalaciones o servicios, que se aparten de los manuales de instrucción o especificaciones de fluidal.
- El uso inadecuado de instalaciones o negligencia del Comprador, sus Ayudantes o Agentes.
- Las partes suministradas por el Comprador.

DELIVERY TERMS

fluidal saves itself the right to reject an order depending on the availability of the products. In this supposition, fluidal will communicate it to the Customer as promptly as possible.

The delivery time has to be approved by the contractual parts. The delivery time will be calculated from the date of receipt of the confirmation of the order, when fluidal will be able to proceed without any interruption. fluidal will not be responsible for the delays in the supply of all or in part of the goods in case of major force, such as natural catastrophes, legal limitations, strikes, etc., or any other reason beyond our control. In case of any of the reasons previously mentioned, the period of delivery will be extensible to the same period of time that lasts the reason that has motivated the delay. Nevertheless, if the period exceeds six months, fluidal may cancel the part that couldn't be sent, by previously notifying the Customer in writing.

We do our best to respect the delivery times that are indicated in our offers or in our order confirmations, though it is materially impossible to answer completely for the above mentioned fulfillment, since we depend on other suppliers and on unexpected circumstances totally foreign to our possible control. Won't be accepted any sanctions for the delay in the foreseen delivery.

RIGHT OF PROPERTY

fluidal maintains the property of the materials (products) until the Customer makes the payment in full of the merchandise.

The Customer is responsible for taking the necessary actions to preserve in good condition the merchandise until it has been paid, must insure fluidal of the payment of the same one in case of having being sold to third persons by the Customer.

WARRANTY

We won't attend any claim done after the 12 months following the delivery of the merchandise. Returned material will not be allowed without previous authorization or when the time between the purchase and the request for return exceeds 15 days.

In any case, all returned merchandise will have to be accompanied by a copy of our authorization and, providing that it is not for reasons attributable to fluidal, will carry a minimal surcharge of 20 % on the cost of the returned material, all the expenses will be charged to the customer. Concerning the faults that appear in the supplied products, fluidal will only accept as unique responsibility or obligation, the paying of the product or defective products providing that the products (merchandise) have been treated adequately and that the arisen faults are due to faults of material or manufacture.

The warranty includes the replacement or repair of the defective elements in our workshops. The warranty is understood always in relation with the presumably defective material deposited in our warehouse, but the costs of transport and the risk being at the expense of the Customer. The advices given before and post closing of the contract, are made with the best intention and according to our know-how, nevertheless fluidal does not assume any category of responsibilities in this regard, nor will answer of the eventual direct or indirect damages that could take place indistinctly, no matter who, where and why they may take place.

fluidal will not be responsible for any consequence or indirect damages occurred to the Customer, and / or third Parties including but not limited to loss of opportunities, business and incomes.

fluidal guarantees exclusively its own materials, excluding any responsibility for the effects or damages that these could provoke in facilities, equipments or conductions. In no case will take responsibility for accidents related to individuals or materials or for losses in fabrication.

The warranty excludes the breakdowns produced by badly use or deficient installation, breakdowns provoked by overloading of the equipments for experimental purposes, either for adjustment or testing. fluidal's total responsibility for the caused damages, independently of the type of action or theory of the responsibility, will not exceed the amount of the work done, installation or materials that have been object of the order to fluidal.

Any amount that exceeds the above mentioned quantity, and any amount that fluidal will have to support either for judicial, arbitral or similar decision, will be transmitted to the Customer until obtaining indemnity.

Will be excluded from this warranty:

- The use of facilities or services, which are different of those included in the manuals of instruction or in fluidal's specifications.
- The inadequate use of facilities or negligence of the Customer, his Assistants or Agents.
- The parts supplied by the Customer.

FREIGHTAGES

By merchandise we always mean the one deposited in fluidal's warehouse, even in operations conditioned by the delivery at destination and the merchandise will always travel at the account and risk of the Customer, being at his charge, including the additional insurances that could be established and the special permissions it may need. According to what it is established in the article 18 of the Royal decree 782/1998 concerning wrapping and packaging mentioned in the 1st additional Disposition (Regulation) of the Law 11/1997, the person responsible for the delivery of the residues of the packaging and worn packages, for the correct environmental management, will be the final user.

Condiciones de venta

General conditions of sale

PORTES

La mercancía se entiende siempre depositada en el domicilio de fluidal, incluso en operaciones condicionadas a la entrega en destino y la mercancía siempre viajará por cuenta y riesgo del comprador, siendo a su cargo inclusive los seguros adicionales que pudieran establecerse y los permisos especiales a que hubiera lugar.

Según se establece en el artículo 18 del Real Decreto 782/1998 para los envases y embalajes acogidos a la Disposición adicional 1.ª de la Ley 11/1997, el responsable de la entrega de los residuos de los embalajes y envases usados, para su correcta gestión ambiental, será el usuario final.

ENVÍOS DE EMERGENCIA

Sea cual fuere el medio de transporte utilizado, avión, courier, régimen de equipajes, agencias especiales, mensajeros etc. Independientemente del importe de dicho servicio, el comprador correrá con todos los gastos extra, los de acarreo, de desplazamientos, y de comunicaciones que el servicio haya ocasionado, sin que en ningún caso este valor pueda ser inferior a 60 euros.

PEDIDOS ESPECIALES

Todo pedido de material especial, conllevará el pago anticipado del 50 % del importe del pedido, como condición indispensable para su aceptación. Dicho importe quedará siempre a favor de fluidal como indemnización en cualquier caso de anulación por parte del comprador, sin perjuicio de las reclamaciones que por Ley se puedan tener derecho.

VENTA MÍNIMA

La facturación mínima será de 50 € sea cual sea el importe del pedido.

PAGOS

Los pagos se realizarán como máximo y salvo acuerdo expreso entre las partes, a 60 días desde la fecha de la factura y previa recepción de los informes positivos de crédito. Si el comprador no efectuare el pago de cualquiera de los suministros a su vencimiento, fluidal está autorizado a suspender los envíos posteriores hasta que se realice dicho pago. Cualquier cargo bancario asociado con el pago de la mercancía, así como los gastos de devolución de efectos en caso de impago, serán por cuenta del comprador.

En caso de demora en el pago y sin perjuicio de otros derechos atribuidos al comprador por la legislación en vigor, el comprador abonará a fluidal un interés de demora del 2 % mensual desde la fecha de vencimiento de la factura.

COBRO DE LETRAS O RECIBOS DEVUELTOS O APLAZADOS

Serán a cargo del librado:

- Gastos de devolución.
- Intereses del 1 % mensual desde el día del vencimiento fallido hasta la fecha de cobro definitivo.
- Posible valor del timbre de nuevos documentos.
- Prima de seguro de crédito.

PAGOS COINCIDENTES EN VACACIONES

Si el cliente no pudiese atender los pagos que coincidiesen con periodos vacacionales, éstos se trasladarán al mismo día del mes anterior. En caso de existir días fijos de pago, el vencimiento se trasladará al día hábil de pago inmediatamente anterior.

USO DE SOFTWARE

En la medida en que el volumen de entrega incluye la puesta a disposición de software, el cliente tiene el derecho no exclusivo a usarla incluyendo la documentación adjunta. Se le cede el software para el uso en el objeto de entrega al cual va destinado. No se admite el uso de este software en otro sistema. La modificación, traducción o adaptación de código de objeto a código de origen así como la reproducción de software solamente se admite en la medida legalmente establecida. El cliente se compromete a no retirar las indicaciones del fabricante, especialmente indicaciones del Copyright sin el consentimiento previo de fluidal. Todos los demás derechos sobre el software y la documentación incluyendo las copias, corresponden a fluidal o al proveedor del software. No se admite la concesión de sublicencias.

DERECHO APLICABLE Y JURISDICCIÓN

Las relaciones jurídicas entre DCSA y el comprador están sujetas al derecho Español. El tribunal competente será el del domicilio de fluidal. Sin embargo, fluidal podrá optar por interponer las acciones legales correspondientes en el domicilio del comprador.

EMERGENCY DELIVERIES

No matter the type of the transportation used: by plane, courier, as baggage (luggage), special agencies, messengers etc; independently of the amount of the above mentioned service, the Customer will pay all the extra expenses, those of transportations, of shipping, and of communications that the service has caused; this value may not, under no circumstance, be lower than 60 euros.

SPECIAL ORDERS

Any order (request) of special material, will carry the anticipated payment of 50 % of the amount of the order (request), as an indispensable condition for its acceptance. The above mentioned amount will always be in favor of fluidal as compensation in case of cancellation on the part of the Customer, without prejudice of the claims at which they may have right by Law.

MINIMAL SALE

The minimal invoice will be of 50 €, no matter the amount of the order.

PAYMENTS

The payments have to be done, except express written agreement between the parts, in maximum 60 days from the date of the invoice and previous receipt of the positive reports of credit. If the Customer doesn't make the payment in time, for a part of the merchandise supplied, fluidal is authorized to suspend the posterior deliveries until the Customer executes the due payments. Any bank charges associated with the payment of the merchandise, as well as the expenses of return of it in case of non-payment, will be at the expense of the Customer. In case of delay in the payment and without prejudice of other rights attributed to the buyer for the legislation in effect, the Customer will pay to fluidal an interest of monthly delay of 2 % starting from the date when the invoice comes to its term.

UNPAID OR POST-PONED INVOICES

Will be at the expense of the Customer:

- The return expenses.
- Monthly interests of 1 %, from the day when the payment has come to its term and wasn't made, until the date of full payment.
- Possible amount (value) of the stamp of the new documents.
- The credit insurance.

COINCIDENTAL PAYMENTS IN VACATIONS

If the client could not attend to the payments that were coinciding with vacation periods, these will move to the same day of the previous month. In case there are fixed days of payment, the term of the invoice will move to the immediately previous working day of payment.

THE SOFTWARE USE

If the delivery includes the putting at the disposal of the Customer software, the Customer has the exclusive right to use it, including the attached documentation. The software is sent for the use in the object of delivery to which it is destined. It is forbidden the use of this software into any other system. The modification, translation or adjustment of the code of object to code of origin as well as the reproduction of software is only admitted into the legally established limits. The Customer promises not to withdraw the indications of the manufacturer, especially the indications of the Copyright, without fluidal's previous assent. All the other rights on the software and the documentation including the copies, they belong to fluidal or to the supplier of the software. The concession of sublicenses is not admitted.

GOVERNING LAW AND JURISDICTION

These General Conditions and any agreement between fluidal and the Customer shall be exclusively governed by Spanish laws. The exclusive jurisdiction on any dispute between the fluidal and the Customer shall be the courts of fluidal's domicile. Nevertheless, fluidal has also the right to bring legal action against the Customer before the courts of the place of business and/or residence of the Customer.

